

INSTALLATION INSTRUCTIONS

BCE7E Series Air Handler

This manual must be left with the homeowner for future reference.



This is a safety alert symbol and should never be ignored. When you see this symbol on labels or in manuals, be alert to the potential for personal injury or death.

Table of Contents

<p>General Information.....4</p> <p>Shipping and Packing List.....4</p> <p>Requirements.....4</p> <p>Use of Air Handler During Construction.....4</p> <p>Installing the Unit.....5</p> <p>Brazing Connections.....7</p> <p>Installing the Condensate Drain.....8</p> <p>Inspecting and Replacing Filters.....9</p> <p>Sealing the Unit.....9</p>	<p>Measuring Static Pressure.....9</p> <p>Adjusting Blower Speed.....10</p> <p>Blower Data.....11</p> <p>Making Electrical Connections.....13</p> <p>Homeowner Maintenance.....16</p> <p>Professional Maintenance.....16</p> <p>Repairing or Replacing Cabinet Insulation.....16</p> <p>Check-out Procedures.....17</p>
--	---

NOTE: Special procedures are required for cleaning the OmniGuard™ coil in this unit. See Page 15 in this instruction for information.

IMPORTANT INFORMATION FOR INSTALLER

CHECK FOR AND REMOVE THESE ITEMS BEFORE OPERATING UNIT.

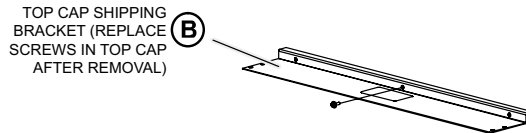
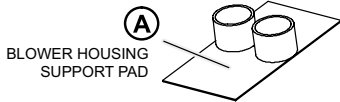

C HORIZONTAL DRAIN PAN (SEE PAGES 5-6)

D REFRIGERANT LINE PLUGS (SEE PAGE 6)

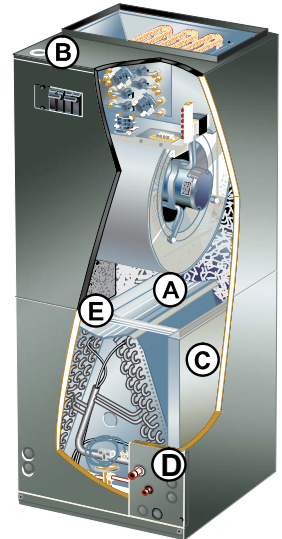
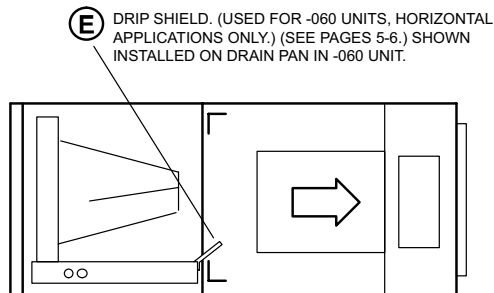

215 Metropolitan Drive
West Columbia, SC 29170



(P) 507838-02

Save these instructions for future reference

BCE7E Upflow and Downflow Unit Dimensions - inches (mm)

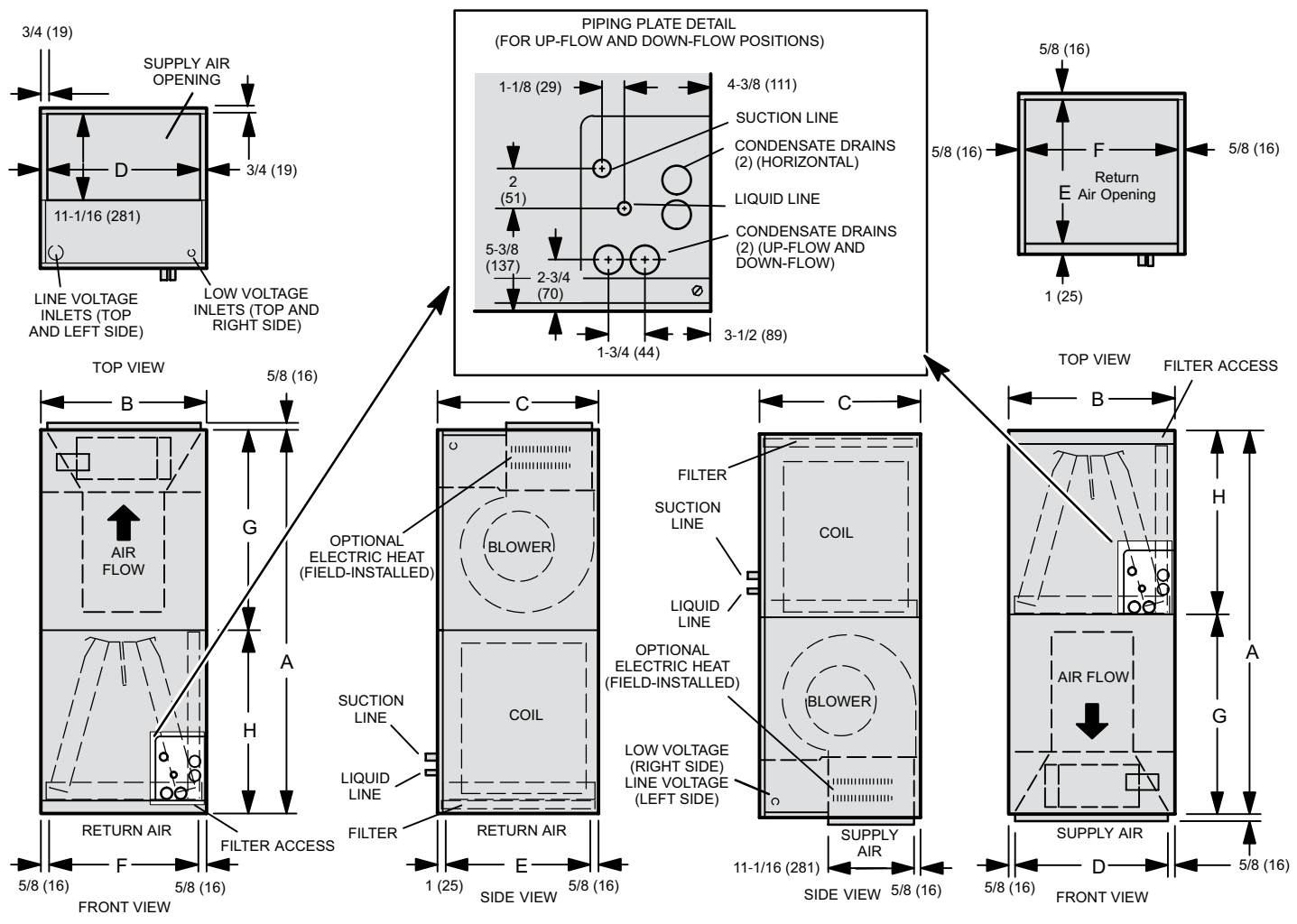

Upflow Position

Downflow Position

BCE7E Common Dimensions - inches (mm)				
Dim.	-018/-024	-030/-036	-042/-048	-060
A	49-1/4 (1251)	51 (1295)	58-1/2 (1486)	62-1/2 (1588)
B	21-1/4 (540)	21-1/4 (540)	21-1/4 (540)	21-1/4 (540)
C	20-5/8 (524)	22-5/8 (575)	24-5/8 (625)	24-5/8 (625)
D	19-3/4 (502)	19-3/4 (502)	19-3/4 (502)	19-3/4 (502)
E	19 (483)	21 (533)	23 (584)	23 (584)
F	20 (508)	20 (508)	20 (508)	20 (508)
G	24-5/8 (625)	26-3/8 (670)	27-7/8 (708)	27-7/8 (708)
H	24-5/8 (625)	24-5/8 (625)	30-5/8 (778)	34-5/8 (879)

BCE7E Horizontal Left- and Right-Hand Discharge Unit Dimensions - inches (mm)

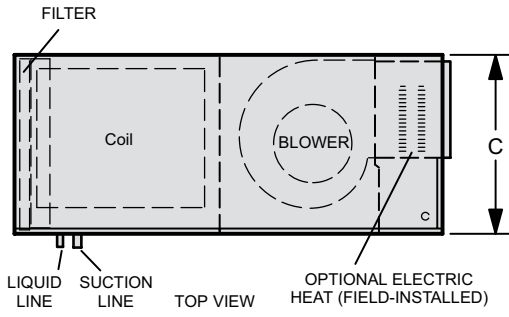
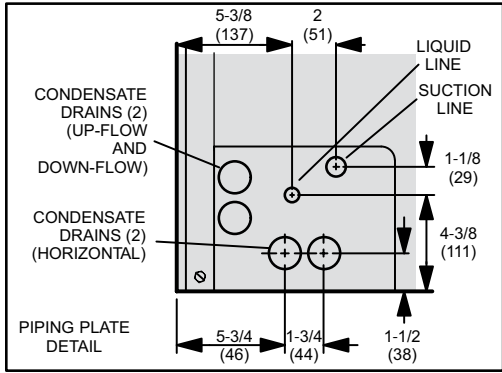

Horizontal Position (Right-Hand Air Discharge)

FOR DIMENSIONS "A" THROUGH "H", SEE CHART ON PAGE 2.

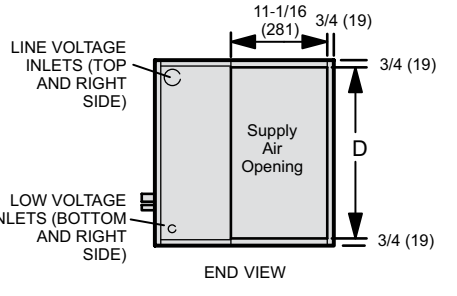
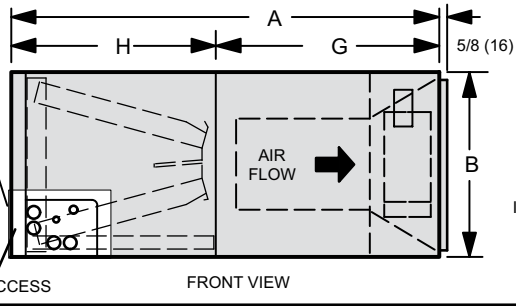
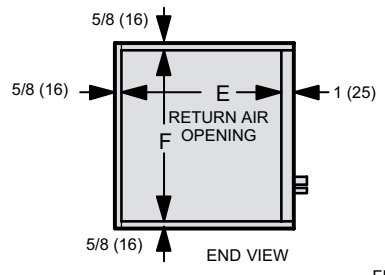

Horizontal Position (Left-Hand Air Discharge)

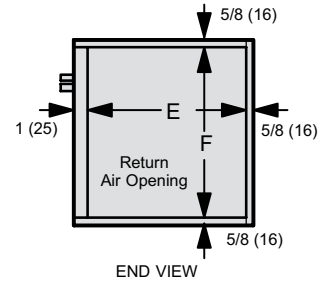
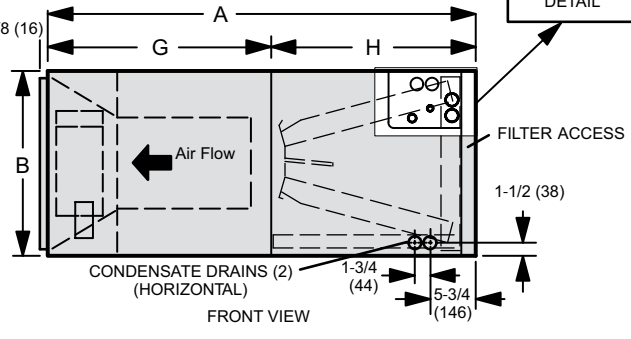
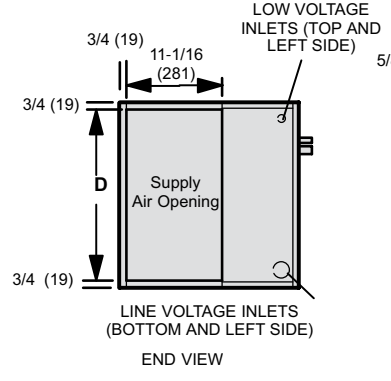
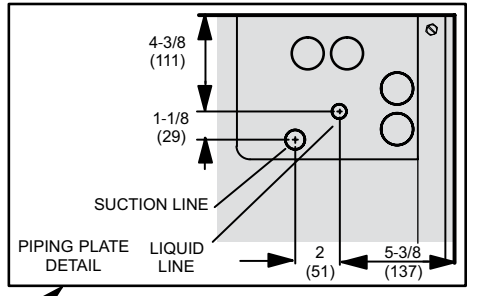
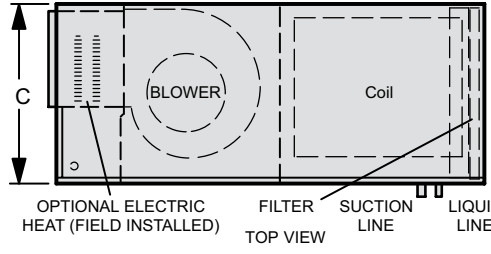

WARNING

Improper installation, adjustment, alteration, service or maintenance can cause property damage, personal injury or loss of life. Installation and service must be performed by a licensed professional HVAC installer or equivalent, service agency, or the gas supplier.

IMPORTANT

The Clean Air Act of 1990 bans the intentional venting of refrigerant (CFCs, HCFCs and HFCs) as of July 1, 1992. Approved methods of recovery, recycling or reclaiming must be followed. Fines and/or incarceration may be levied for noncompliance.

CAUTION

As with any mechanical equipment, contact with sharp sheet metal edges can result in personal injury. Take care while handling this equipment and wear gloves and protective clothing.

General Information

The BCE7E series air handler with Omniguard™ coil is designed for installation with optional field-installed electric heat and a matching HFC-410A outdoor unit.

This instruction is intended as a general guide and does not supersede local or national codes in any way. Consult authorities having jurisdiction before installation.

Shipping and Packing List

Package 1 of 1 contains:

- 1 – Assembled air handler unit
- 1 – Horizontal drip shield (BCE7E-060 only)
- 1 – Pipe nipple (Sch 80, 3/4" I.D. x 5")
- 1 – Warranty card

NOTE: For downflow applications, order kit number 83M57.

Check the air handler for shipping damage; if found, immediately contact the last carrier.

Requirements

IMPORTANT

This unit must be matched with an indoor coil as specified in the product specification sheets. Coils previously charged with HCFC-22 must be flushed.

In addition to conforming to manufacturer's installation instructions and local municipal building codes, installation of air handler units (with or without optional electric heat), shall conform with the following National Fire Protection Association (NFPA) standards:

- NFPA No. 90A - Standard for Installation of Air Conditioning and Ventilation Systems
- NFPA No. 90B - Standard for Installation of Residence Type Warm Air Heating and Air Conditioning Systems

This unit is approved for installation clearance to combustible material as stated on the unit rating plate. Accessibility and service clearances must take precedence over combustible material clearances.

Use of Air Handler During Construction

Units may be used for heating (heat pumps) or cooling of buildings or structures under construction, if the following conditions are met to ensure proper operation.

DO NOT USE THE UNIT FOR CONSTRUCTION HEAT UNLESS ALL OF THE FOLLOWING CRITERIA ARE MET:

- A room thermostat must control the air handler. The use of fixed jumpers is not allowed.
- Air filter must be installed in the system and must be maintained during construction.
- Air filter must be replaced upon construction completion.
- The air handler evaporator coil, supply fan assembly and duct system must be thoroughly cleaned following final construction clean-up.
- All air handler operating conditions must be verified according to these installation instructions.

EQUIPMENT MAY EXPERIENCE PREMATURE COMPONENT FAILURE AS A RESULT OF FAILURE TO FOLLOW THE ABOVE INSTALLATION INSTRUCTIONS. FAILURE TO FOLLOW THE ABOVE INSTALLATION INSTRUCTIONS VOIDS THE MANUFACTURER'S EQUIPMENT LIMITED WARRANTY. ALLIED AIR DISCLAIMS ALL LIABILITY IN CONNECTION WITH INSTALLER'S FAILURE TO FOLLOW THE ABOVE INSTALLATION INSTRUCTIONS.

NOTWITHSTANDING THE FOREGOING, INSTALLER IS RESPONSIBLE FOR CONFIRMING THAT THE USE OF CONSTRUCTION HEAT OR COOLING IS CONSISTENT WITH THE POLICIES AND CODES OF ALL REGULATING ENTITIES. ALL SUCH POLICIES AND CODES MUST BE ADHERED TO.

Installing the Unit

These units are factory-configured for upflow and horizontal right-hand discharge installation. For downflow or horizontal left-hand discharge, certain field modifications are required.

Disassemble/Reassemble Air Handler Units

The air handler units consists of two factory-assembled sections. It may be necessary to disassemble the sections when positioning the unit for installation.

To disassemble:

1. Remove access panels.
2. Remove both blower and coil assemblies. This will lighten the cabinet for lifting.
3. Remove one screw from the left and right posts inside the unit. Remove one screw from each side on the back of the unit. Unit sections will now separate.

To reassemble:

1. Align cabinet sections together.
2. Reinstall screws.
3. Replace blower and coil assemblies.
4. Replace access panel.

Upflow Application

Use the following procedures to configure the unit for upflow operations:

1. Remove access panels.
2. Remove and discard the horizontal drip shield (-060 model, used only on horizontal applications) and the corrugated padding between the blower and coil assembly.
3. The horizontal drain pan must be removed when the coil blower is installed in the upflow position. Removing the horizontal drain pan will allow proper air flow and increased efficiency.
4. After removing the horizontal drain pan, place the unit in the desired location. Set unit so that it is level. Connect return and supply air plenums as required using sheet metal screws as illustrated in Figure 1.
5. Install units that have no return air plenum on a stand that is at least 14" from the floor to allow for proper air return. An optional upflow unit stand is listed in Table 1.

Model	Kit Number
All Sizes	45K32

Table 1. Optional Side-Return Unit Stand (Upflow Only)

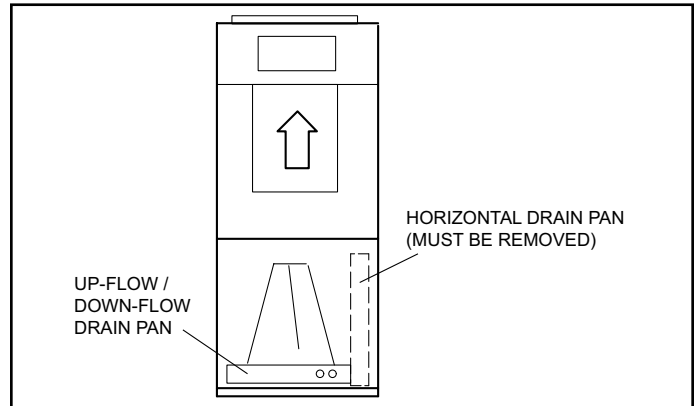

Figure 1. Upflow Configuration

Horizontal Right-Hand Discharge Application

Use the following procedures to configure the unit for horizontal right-hand discharge operations:

NOTE: For horizontal applications, a secondary drain pan is recommended. Refer to local codes.

1. Before operating the unit, remove access panels and the horizontal drip shield (-060 model) and the corrugated padding between the blower and coil assembly. Discard the corrugated padding.
2. Install the horizontal shield on the front edge of the horizontal drain pan as illustrated in Figure 2.
3. No further adjustment is necessary. Set unit so that it is sloped 1/4" towards the drain pan end of the unit.
4. If the unit is suspended, the entire length of the cabinet must be supported. If you use a chain or strap, use a piece of angle iron or sheet metal attached to the unit (either above or below) to support the length of the cabinet. Use securing screws no longer than 1/2" to avoid damaging the coil or filter as illustrated in Figure 3. Use sheet metal screws to connect the return and supply air plenums as required.

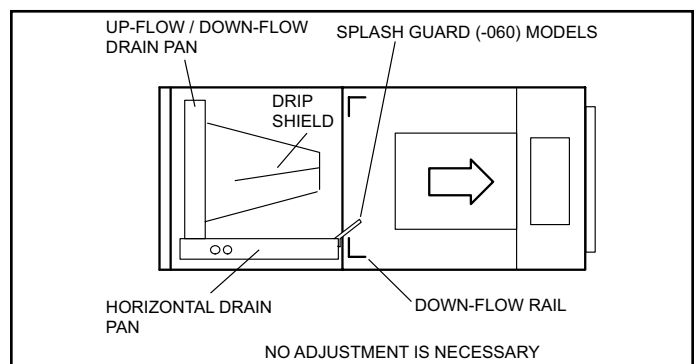

Figure 2. Right-Hand Discharge Configuration

Horizontal Right-Hand Discharge Application in High-Humidity Areas

For horizontal applications in high humidity areas, remove the downflow rail closest to the drain pan.

To remove rail:

1. Remove the screws from the rail at the back of unit and at the cabinet support rail.
2. Remove the downflow rail then replace screws.
3. Seal around the exiting drain pipe, liquid line, and suction line to prevent humid air from infiltrating into the unit.

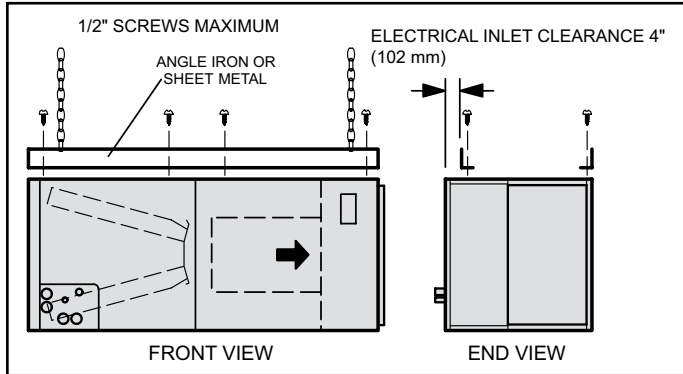

Figure 3. Suspending Horizontal Unit

⚠ IMPORTANT

When removing the coil, there is possible danger of equipment damage and personal injury. Be careful when removing the coil assembly from a unit installed in right- or left-hand applications. The coil may tip into the drain pan once it is clear of the cabinet. Support the coil when removing it.

Horizontal Left-Hand Discharge Application

NOTE: For horizontal applications, a secondary drain pan is recommended. Refer to local codes.

Use the following procedures to configure the unit for horizontal left-hand discharge operations:

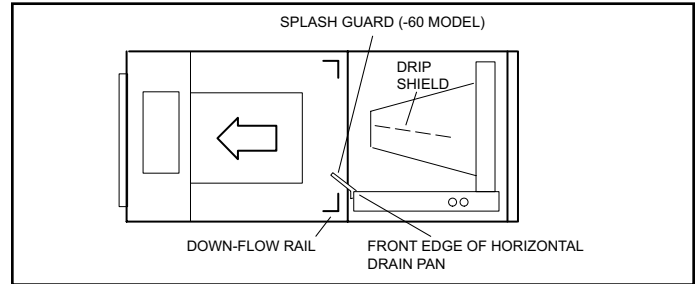

Figure 4. Left-Hand Discharge Configuration

1. Before operating the unit, remove access panels and the horizontal drip shield (-060 model) and the corrugated padding between the blower and coil assembly. Discard the corrugated padding.
2. Pull the coil assembly from unit. Pull off the horizontal drain pan.
3. Remove the drain plugs from back drain holes on horizontal drain pan and reinstall them on front holes.

⚠ IMPORTANT

After removal of drain pan plug(s), check drain hole(s) to verify that drain opening is fully open and free of any debris. Also check to make sure that no debris has fallen into the drain pan during installation that may plug up the drain opening.

4. Rotate drain pan 180° front-to-back and install it on the opposite side of the coil.

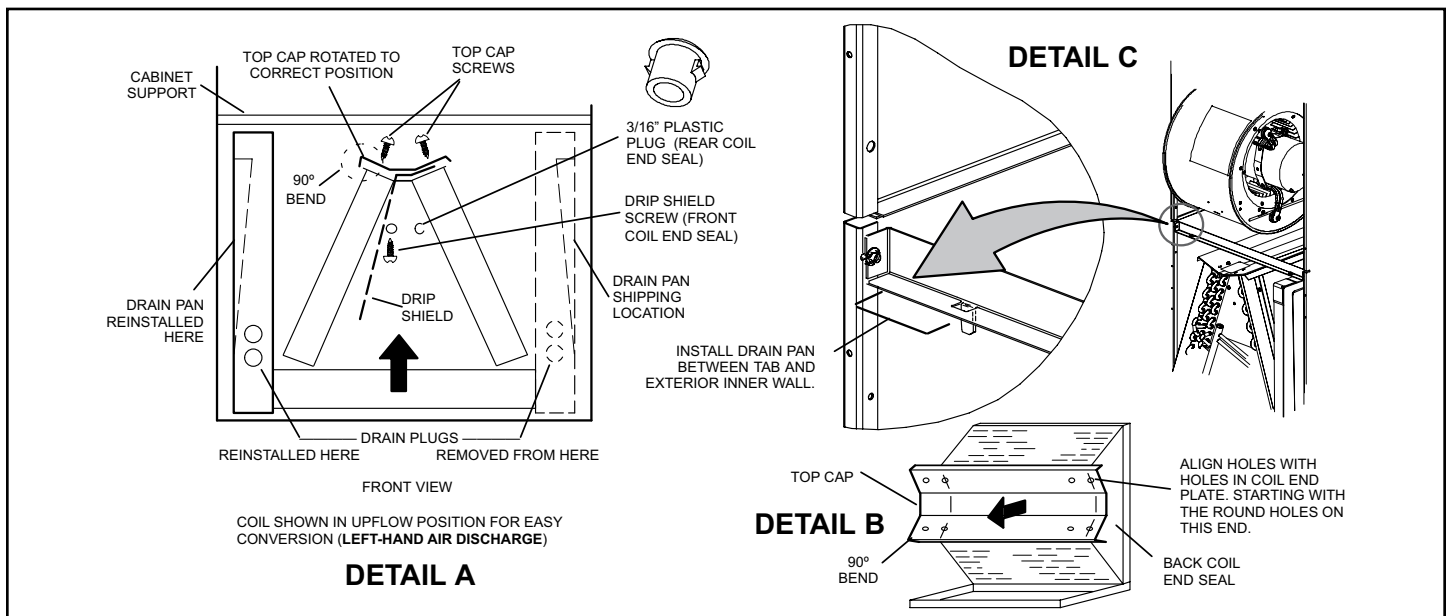

Figure 5. Field Modification for Left-Hand Discharge

5. Remove screws from top cap. Remove drip shield screw located in the center of the back coil end seal as illustrated in Detail A in Figure 5.
6. Rotate drip shield 180° front-to-back.
7. Remove plastic plug from left hole on coil front end seal and reinstall plug in back hole. Reinstall drip shield screw in front coil end seal. Drip shield should drain downward into horizontal drain pan inside coil.
8. Rotate top cap 180° front-to-back and align with unused screw holes. Holes must align with front and back coil end plates (see Detail B in Figure 5). The top cap has a 45° bend on one side and a 90° bend on the other. **The 90° bend must be on the same side as the horizontal drain pan** as illustrated in Detail A in Figure 5.

NOTE: *Be very careful when reinstalling the screws into the coil end plate engaging holes. Misaligned screws may damage the coil.*

9. From the upflow position, flip cabinet 90° to the left and set into place. Replace blower assembly. Secure coil in place by bending down the tab on the cabinet support rail as illustrated.

NOTE: *Seal around the exiting drain pipe, liquid and suction lines to prevent infiltration of humid air.*

10. Install the splash guard (-060 model only) on the front edge of the horizontal drain pan as illustrated in Figure 4.

NOTE: *For horizontal applications in high humidity areas, remove the downflow rail closest to the drain pan. To remove rail, remove screw from rail at back of unit and at cabinet support rail. Remove downflow rail then replace screws. Also, seal around the exiting drain pipe, liquid and suction lines to prevent infiltration of humid air.*

11. Knock out drain seal plate from access door. Secure plate to cabinet front flange with screw provided.
12. Flip access door and replace it on the unit.
13. Set unit so that it is sloped 1/4" toward the drain pan end of the unit. Connect return and supply air plenums as required using sheet metal screws.
14. If suspending the unit, it must be supported along the entire length of the cabinet. If using chain or strap, use a piece of angle iron or sheet metal attached to the unit (either above or below) so that the full length of the cabinet is supported. Use securing screws no longer than 1/2" to avoid damage to coil or filter, as illustrated in Figure 3. Connect return and supply air plenums as required using sheet metal screws.

Downflow Application

NOTE: *If downflow application is required, separately order kit number 83M57 and install per kit's instructions. Also use metal or class I supply and return air plenums. Use the installation instruction provided with the downflow kit.*

IMPORTANT

If electric heat section with circuit breakers (AEHK) is installed in a BCE7E unit in a downflow application, the circuit breakers must be rotated 180° to the UP position. See AEHK installation instructions for more details.

Brazing Connections

IMPORTANT

To prevent the build-up of high levels of nitrogen when purging, it must be done in a well-ventilated area. Purge low-pressure nitrogen (1 to 2 psig) through the refrigerant piping during brazing. This will help to prevent oxidation and the introduction of moisture into the system.

All coils are equipped with a factory-installed, internally mounted check/expansion valve.

Model	Liquid Line	Vapor Line	Line Sets
-018 -024 -030 -036	3/8" (10mm)	3/4" (19mm)	L15 line set sizes are dependant on unit match-up.
-042 -048		7/8" (22mm)	
-060			Field supplied

Table 2. Refrigerant Line Sizes

WARNING



To prevent the build-up of high levels of nitrogen when purging, it must be done in a well-ventilated area. Purge low-pressure nitrogen (1 to 2 psig, 6.9 to 13.8 kPa) through the refrigerant piping during brazing. This will help to prevent oxidation and the introduction of moisture into the system.

NOTE: *BCE7E series air handlers use nitrogen or dry air as a holding charge. If there is no pressure when the rubber plugs are removed, check the coil for leaks before installing. After installation, pull a vacuum on the line set and coil before releasing the unit charge into the system.*

NOTE: *See outdoor unit instructions on how to flow nitrogen through line sets.*

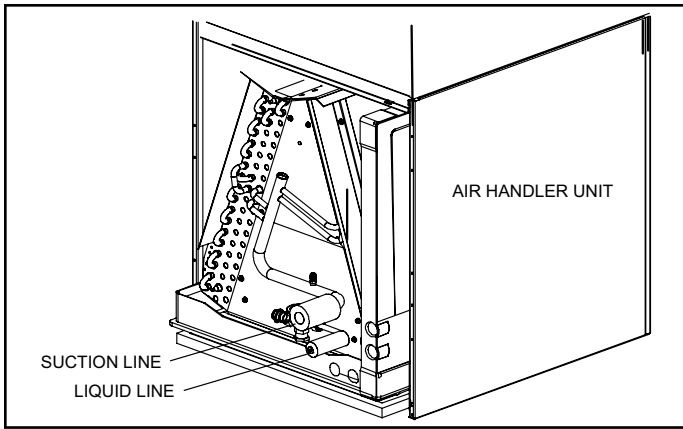

Figure 6. Brazing Connections

1. Remove access panel.
2. Remove the refrigerant line caps from the refrigerant lines.
3. Use a wet rag to protect TXV sensing bulb (or remove it) when brazing suction line connections.
4. Place a wet rag against piping plate and around the suction line connection. The wet rag must be in place to guard against damage to the paint.

5. With the wet rag in place, position a field provided elbow fitting to the air handler's suction line and line set. Start nitrogen flow before brazing.
6. After the procedure is completed then remove the wet rag.
7. Place wet rag against piping plate and around the liquid line connection. Position liquid line elbow to air handler's suction line and to line set. Start nitrogen flow and begin brazing both connections and after procedure is completed then remove both wet rags.
8. Refer to instructions provided with outdoor unit for leak testing, evacuating and charging procedures.
9. Install access panel.

Installing the Condensate Drain

Main Drain

Connect the main drain and route downward to drain line or sump. Do not connect drain to a closed waste system. See Figure 7 for typical drain trap configuration.

Overflow Drain

It is recommended that the overflow drain is connected to an overflow drain line for all units. If overflow drain is not connected, it must be plugged with provided cap.

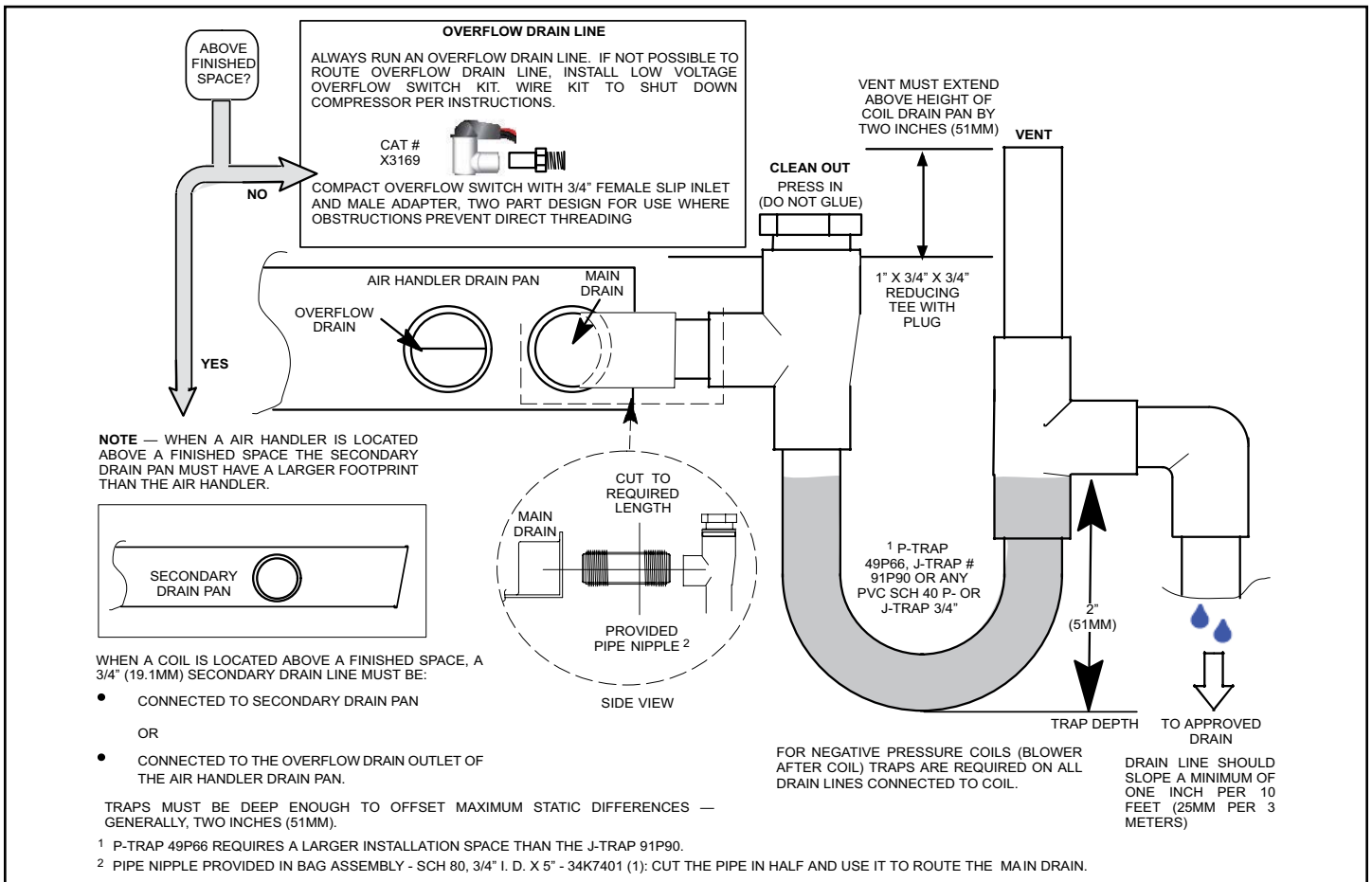

Figure 7. Typical Main and Overflow Drain

For downflow orientation, the overflow drain **MUST** be connected and routed to a overflow drain line. See Figure 8 for main and overflow drain locations based on coil orientation.

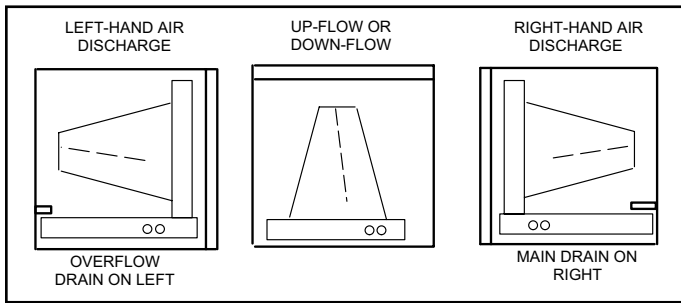

Figure 8. Main and Overflow Drain Locations Based on Coil Orientation

Best Practices

The following best practices are recommended for the condensate removal process:

- Main and overflow drain lines should **NOT** be smaller than both drain connections at drain pan.
- Overflow drain line should run to an area where homeowner will notice drainage.
- It is recommended that the overflow drain line be vented and a trap installed. Refer to local codes.
- Condensate drain lines must be configured or provided with a cleanout to permit the clearing of blockages and for maintenance without requiring the drain line to be cut.

Inspecting and Replacing Filters

⚠ IMPORTANT

Filter access panel must be in place during unit operation. Excessive warm air entering the unit may result in water blow-off problems.

Filters may be duct-mounted or installed in the cabinet. A filter is installed at the factory. Note that filter access door fits over access panel. Air will leak if the access panel is placed over the filter door.

Filters should be inspected monthly and must be cleaned or replaced when dirty to assure proper air handler operation.

Reusable filters supplied with some units can be washed with water and mild detergent. Some units are equipped with standard throw-away type filters which should be replaced when dirty.

To replace filter:

1. Loosen the thumbscrews holding the filter panel in place. Remove the dirty filter.
2. Insert new filter and replace panel.

BCE7E	Filter Size – In. (mm)
-018, -024, -030, -036	20" x 20" (508mm x 508mm)
-042, -048, -060	20" x 24" (508mm x 610mm)

Table 3. Filter Dimensions

Sealing the Unit

⚠ WARNING

There must be an airtight seal between the bottom of the air handler and the return air plenum. Use fiberglass sealing strips, caulking, or equivalent sealing method between the plenum and the air handler cabinet to ensure a tight seal. Return air must not be drawn from a room where this air handler or any gas-fueled appliance (i.e., water heater), or carbon monoxide-producing device (i.e., wood fireplace) is installed.

Seal the unit so that warm air is not allowed into the cabinet. Warm air introduces moisture, which results in water blow-off problems. This is especially important when the unit is installed in an unconditioned area.

Make sure the liquid line and suction line entry points are sealed with either the provided flexible elastomeric thermal insulation, or field provided material (e.g. Armaflex, Permagem or equivalent). Any of the previously mentioned materials may be used to seal around the main and auxiliary drains, and around open areas of electrical inlets.

Measuring Static Pressure

1. Measure tap locations as shown in Figure 9.

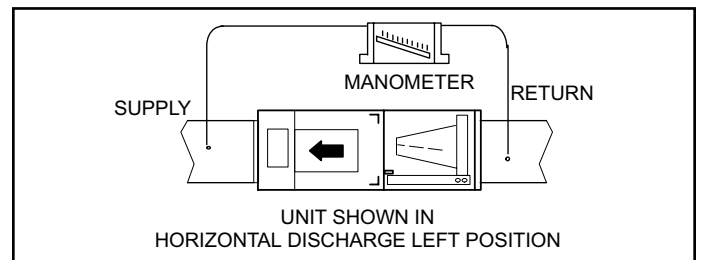

Figure 9. Static Pressure Test

2. Punch a 1/4" (6mm) diameter hole in supply and return air plenums. Insert manometer hose flush with inside edge of hole or insulation. Seal around the hose with Permagem. Connect the zero end of the manometer to the discharge (supply) side of the system. On ducted

systems, connect the other end of manometer to the return duct as above. For systems with non-ducted returns, leave the other end of the manometer open to the atmosphere.

3. With only the blower motor running and the evaporator coil dry, observe the manometer reading. Adjust blower motor speed to deliver the air desired according to the job requirements.
4. For best air performance external static pressure drop must not exceed 0.5" W.C. (1.2 kPa). Refer to blower data tables for CFM and external static.
5. Seal around the hole when the check is complete.

Adjusting Blower Speed

Motor Speed Taps

NOTE: Motor is programmed for a 45-second delayed OFF on all speed taps except TAP #1 (continuous fan speed).

Table 4 lists the recommended factory blower speed tap selections for BCE7E series units.

Operation	BCE7E	Outdoor Unit	Tap
Cooling	All Sizes	Air conditioner	3
		Heat pump	3
Heating*		Air conditioner with electric heat only	4
		Heat pump with electric heat	4
* Minimum setting for heat			

Table 4. Recommended Blower Speed Tap Selection

These settings are for nominal tonnage match-ups with the BCE7E units. When matched with other sizes, it is recommended that the CFM be adjusted to approximately 400 CFM per ton.

To change blower motor speed tap remove the speed tap from Y2 on the terminal strip and insert the desired speed tap. Use the Blower Data tables for the desired CFM setting.

 IMPORTANT

The high-efficiency programmable motor features programmed electronic braking. The integral control brakes the motor near the end of the supply blower operation, allowing the motor to maintain a more controlled ramping shut-down.

Tap	Operation	Remarks
1	Continuous or low-speed fan (for two-speed heat pumps or AC units)	Continuous fan speed is energized (24V input to G) when either G or Y1 has a 24V signal (24V input from Y1 passes through the room thermostat's Fan Automatic contacts to the G terminal).
2	Low-speed operation on high-static system	CFM set at 1/2 ton less than nominal of unit (e.g. 3-ton set at 1000 CFM).
3	Cooling speed setting	CFM set at 400 cfm per nominal ton at ARI minimum static allowed, as follows: 1.5 to 2.0 ton - 0.10 2.5 to 3.5 ton - 0.15 4 to 5 ton - 0.20
4	Heat pump with electric heat	CFM set at 400 cfm per nominal ton at .4 static. Energized when electric heat element has a call for heat.
5	High-static applications	CFM set at 400 cfm per nominal ton at .8 static.

Table 5. Motor Speed Taps

Blower Data

BCE7E-018 Blower Performance

External Static Pressure in. w.g.	Air Volume and Motor Watts									
	Tap 1		Tap 2		Tap 3		Tap 4		Tap 5	
	cfm	watts	cfm	watts	cfm	watts	cfm	watts	cfm	watts
.10	717	66	707	63	735	74	781	81	959	133
.20	596	58	570	54	636	70	737	91	922	144
.30	473	56	430	48	603	77	697	101	877	150
.40	402	61	335	54	540	81	651	105	846	161
.50	358	67	302	60	492	92	607	117	811	173
.60	295	74	248	63	434	94	561	121	769	179
.70	262	79	202	72	399	103	507	131	727	187
.80	N/A	N/A	N/A	N/A	348	108	459	137	695	196

BCE7E-024 Blower Performance

External Static Pressure in. w.g.	Air Volume and Motor Watts									
	Tap 1		Tap 2		Tap 3		Tap 4		Tap 5	
	cfm	watts	cfm	watts	cfm	watts	cfm	watts	cfm	watts
.10	767	78	753	75	826	88	957	131	1095	189
.20	662	68	648	66	791	100	937	142	1063	199
.30	615	76	612	77	750	108	895	149	1040	211
.40	561	83	539	83	711	116	861	160	1010	226
.50	522	87	507	89	681	126	821	172	970	230
.60	450	96	438	93	628	134	778	175	944	237
.70	419	100	411	103	584	142	750	186	905	248
.80	365	110	358	108	521	147	702	194	864	256

BCE7E-030 Blower Performance

External Static Pressure in. w.g.	Air Volume and Motor Watts									
	Tap 1		Tap 2		Tap 3		Tap 4		Tap 5	
	cfm	watts	cfm	watts	cfm	watts	cfm	watts	cfm	watts
.10	1061	115	1104	126	1169	154	1212	166	1278	200
.20	941	103	973	118	1070	144	1157	173	1241	210
.30	789	90	848	104	1019	151	1121	185	1201	223
.40	640	83	789	111	991	165	1077	199	1169	233
.50	525	93	728	118	946	175	1038	209	1124	244
.60	469	101	629	128	900	181	1006	215	1100	256
.70	434	104	581	139	851	194	956	230	1051	268
.80	365	116	521	155	754	208	915	237	1000	275

BCE7E-036 Blower Performance

External Static Pressure in. w.g.	Air Volume and Motor Watts									
	Tap 1		Tap 2		Tap 3		Tap 4		Tap 5	
	cfm	watts	cfm	watts	cfm	watts	cfm	watts	cfm	watts
.10	1074	134	1099	147	1264	206	1343	240	1498	340
.20	962	121	1027	143	1222	220	1291	253	1467	344
.30	887	126	989	153	1192	234	1269	266	1433	364
.40	852	136	944	164	1144	242	1224	280	1391	378
.50	791	150	894	172	1111	257	1194	286	1365	383
.60	717	160	820	186	1067	266	1153	297	1320	398
.70	649	168	745	202	1037	270	1118	309	1290	407
.80	606	183	697	213	999	284	1081	317	1247	422

BCE7E-042 Blower Performance

External Static Pressure in. w.g.	Air Volume and Motor Watts									
	Tap 1		Tap 2		Tap 3		Tap 4		Tap 5	
	cfm	watts	cfm	watts	cfm	watts	cfm	watts	cfm	watts
.10	1282	177	1346	201	1497	261	1489	261	1723	396
.20	1143	159	1278	204	1475	281	1461	273	1690	408
.30	1067	162	1233	209	1447	297	1427	290	1656	434
.40	1024	175	1199	223	1406	315	1407	305	1639	436
.50	920	189	1154	235	1376	320	1360	324	1599	462
.60	923	197	1099	252	1345	338	1328	336	1573	473
.70	838	204	1022	267	1294	358	1303	351	1541	485
.80	815	218	1003	375	1238	375	1228	373	1494	515

BCE7E-048 Blower Performance

External Static Pressure in. w.g.	Air Volume and Motor Watts									
	Tap 1		Tap 2		Tap 3		Tap 4		Tap 5	
	cfm	watts	cfm	watts	cfm	watts	cfm	watts	cfm	watts
.10	1359	190	1509	257	1718	362	1773	401	1903	511
.20	1238	174	1473	273	1690	380	1758	419	1899	515
.30	1135	172	1453	289	1658	397	1707	434	1868	535
.40	1090	180	1450	290	1619	412	1687	449	1830	553
.50	1032	195	1374	315	1588	431	1660	465	1801	558
.60	980	204	1336	331	1561	440	1618	472	1770	582
.70	929	223	1295	339	1510	457	1593	493	1733	600
.80	867	235	1227	363	1488	473	1552	508	1703	618

BCE7E-060 Blower Performance

External Static Pressure in. w.g.	Air Volume and Motor Watts									
	Tap 1		Tap 2		Tap 3		Tap 4		Tap 5	
	cfm	watts	cfm	watts	cfm	watts	cfm	watts	cfm	watts
.10	1404	206	1704	340	1886	453	1928	481	2268	800
.20	1295	194	1658	349	1849	467	1905	510	2228	829
.30	1256	204	1631	365	1806	489	1869	525	2192	830
.40	1199	217	1594	386	1784	505	1842	546	2169	856
.50	1145	236	1549	394	1751	523	1799	548	2136	870
.60	1091	248	1508	413	1720	534	1775	569	2106	894
.70	978	270	1474	433	1683	549	1741	592	2089	907
.80	946	279	1440	453	1655	566	1709	611	2050	925

Making Electrical Connections

⚠ WARNING

Run 24V Class II wiring only through specified low voltage opening. Run line voltage wiring only through specified high voltage opening. Do not combine voltage in one opening.

⚠ CAUTION

USE COPPER CONDUCTORS ONLY.

This unit is provided with knock-outs for conduit. Refer to Figure 11 for unit wiring diagram, which includes all field wiring. Separate openings have been provided for 24V low voltage and line voltage. Refer to the dimension illustration on Page 2 or Page 3 for specific location.

Wiring must conform to the current National Electric Code ANSI/NFPA No. 70, or Canadian Electric Code Part I, CSA Standard C22.1, and local building codes. Refer to following wiring diagrams. See unit nameplate for minimum circuit ampacity and maximum overcurrent protection size.

Select the proper supply circuit conductors in accordance with tables 310-16 and 310-17 in the National Electric Code, ANSI/NFPA No. 70 or tables 1 through 4 in the Canadian Electric Code, Part I, CSA Standard C22.1.

The motor speed is set by the speed tap connection to the low voltage terminal strip in the control section. The speed can be increased by swapping wires as shown in Figure 11.

Wiring Connections

1. Install line voltage power supply to unit from a properly installed circuit breaker.
2. Ground unit at unit disconnect switch or to an earth ground.

NOTE: Connect conduit to the unit using a proper conduit fitting. Units are approved for use only with copper conductors. A complete unit wiring diagram is located on the back side of the unit's access panel.

3. Install low voltage wiring from outdoor to indoor unit and from thermostat to indoor unit.

NOTE: For proper voltages, select thermostat wire gauge per the following chart:

Wire Run Length	AWG#	Insulation / Core Types
Less than 100' (30m)	18	Color coded, temperature rating 95°F (35°C) minimum, solid core
More than 100' (30m)	16	

Table 6. Run Length (Class II Rated Wiring)

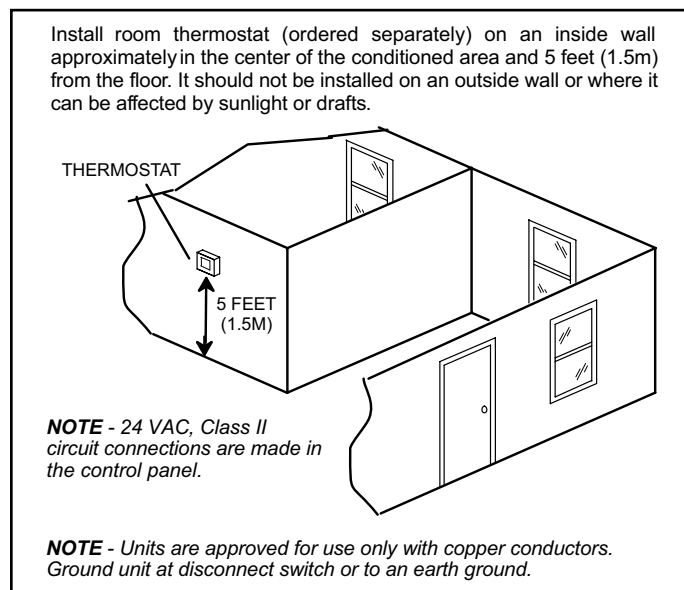
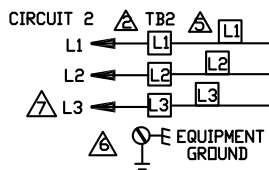

Figure 10. Thermostat Installation

FIELD WIRING FOR UNITS WITHOUT CIRCUIT BREAKERS



- ⚠ CONNECT POWER WIRES FROM HEATER LABELED L1,L2 ON "P" VOLTAGE UNITS AND L1,L2,L3 ON "Y" VOLTAGE UNITS TO TB2 TERMINAL STRIP IN INDOOR UNIT
- ⚠ EQUIPMENT GROUND LOCATED IN INDOOR UNIT

FIELD WIRING FOR UNITS WITH CIRCUIT BREAKERS

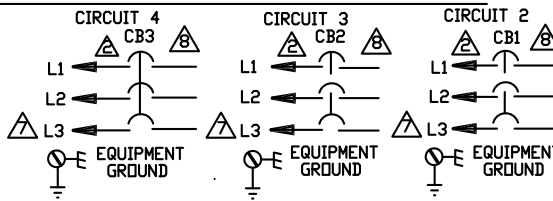

- ⚠ L3 IS NOT PRESENT ON (P) ELECTRIC HEATERS
- ⚠ THE NUMBER OF CIRCUITS VARY ACCORDING TO HEATER MODEL. REFER TO FAN COIL NAMEPLATE FOR ACTUAL NUMBER EMPLOYED

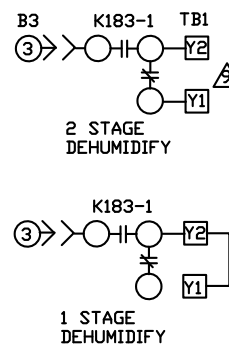
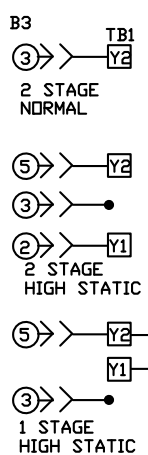
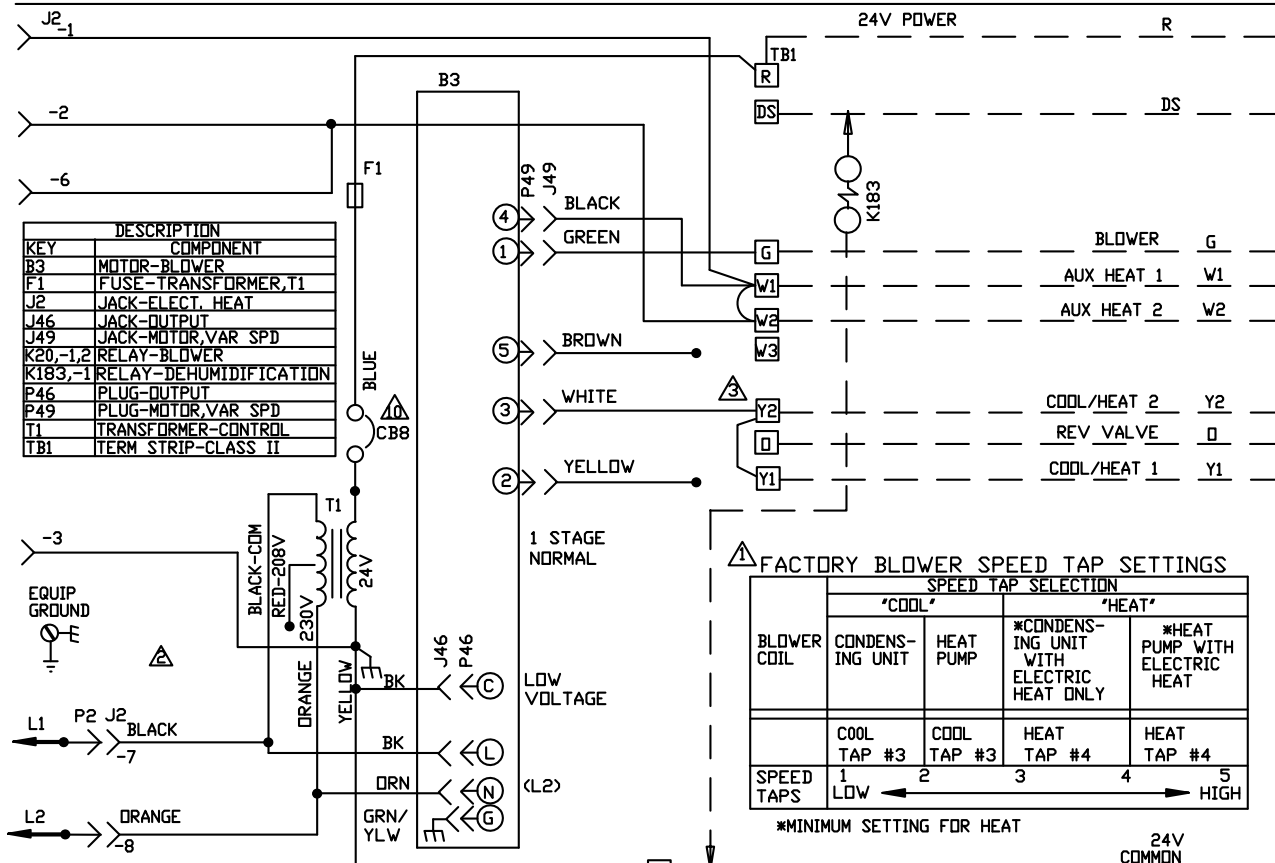

- ⚠ FOR HIGH STATIC APPLICATION, REFERENCE DEHUMIDIFICATION KIT INSTRUCTIONS
- ⚠ TRANSFORMER MAY OR MAY NOT HAVE A CIRCUIT BREAKER

- ⚠ REFER TO FACTORY BLOWER SPEED TAP SELECTION CHART FOR BLOWER SPEED INFORMATION AND UNIT INSTRUCTIONS FOR ADDITIONAL BLOWER SETTINGS
- ⚠ USE COPPER CONDUCTORS ONLY. REFER TO UNIT NAMEPLATE FOR MINIMUM CIRCUIT AMPACITY AND MAXIMUM OVERCURRENT PROTECTION SIZE
- ⚠ JUMPER "Y1" TO "Y2" IS FOR SINGLE STAGE COOLING. REMOVE JUMPER "Y1" TO "Y2" FOR TWO STAGE COOLING.
- ⚠ FOR STAGING OF ELECTRIC HEAT, REMOVE W1 TO W2 JUMPER

COILS-BLOWER COIL UNITS

BCE7E-018 THRU 060 UNITS

Supersedes

0619



Form No.
537970-02

© 2011

Litho U.S.A.

Figure 11. Typical System Wiring Diagram

Homeowner Maintenance

IMPORTANT

Do not operate system without a filter. A filter is required to protect the coil, blower, and internal parts from excessive dirt and dust. The filter is placed in the return duct by the installer.

- Inspect air filters at least once a month and replace or clean as required. Dirty filters are the most common cause of inadequate heating or cooling performance.
- Replace disposable filters. Cleanable filters can be cleaned by soaking in mild detergent and rinsing with cold water.
- Install new/clean filters with the arrows on the side pointing in the direction of air flow. Do not replace a cleanable (high velocity) filter with a disposable (low velocity) filter unless return air system is properly sized for it.
- If water should start coming from the secondary drain line, a problem exists which should be investigated and corrected. Contact a qualified service technician.

Professional Maintenance

NOTICE

Failure to follow instructions will cause damage to the unit.

This unit is equipped with an aluminum Omniguard™ coil. Aluminum coils may be damaged by exposure to solutions with a pH below 5 or above 9. The aluminum coil should be cleaned using potable water at a moderate pressure (less than 50psi). If the coil cannot be cleaned using water alone, it is recommended to use a coil cleaner with a pH in the range of 5 to 9. The coil must be rinsed thoroughly after cleaning.

In coastal areas, the coil should be cleaned with potable water several times per year to avoid corrosive buildup (salt).

Repairing or Replacing Cabinet Insulation

IMPORTANT

DAMAGED INSULATION MUST BE REPAIRED OR REPLACED before the unit is put back into operation. Insulation loses its insulating value when wet, damaged, separated or torn.

Matte- or foil-faced insulation is installed in indoor equipment to provide a barrier between outside air conditions (surrounding ambient temperature and humidity) and the varying conditions inside the unit. If the insulation barrier is damaged (wet, ripped, torn or separated from the cabinet walls), the surrounding ambient air will affect the inside surface temperature of the cabinet. The temperature/humidity difference between the inside and outside of the cabinet can cause condensation on the inside or outside of the cabinet which leads to sheet metal corrosion and subsequently, component failure.

Repairing Damaged Insulation

Areas of condensation on the cabinet surface are an indication that the insulation is in need of repair.

If the insulation in need of repair is otherwise in good condition, the insulation should be cut in an X pattern, peeled open, glued with an appropriate all-purpose glue and placed back against the cabinet surface, being careful to not overly compress the insulation so the insulation can retain its original thickness. If such repair is not possible, replace the insulation. If using foil-faced insulation, any cut, tear, or separations in the insulation surface must be taped with a similar foil-faced tape.

IMPORTANT

Electric Shock Hazard.

Can cause injury or death.



Foil-faced insulation has conductive characteristics similar to metal. Be sure there are no electrical connections within 1/2" of the insulation. If the foil-faced insulation comes in contact with electrical voltage, the foil could provide a path for current to pass through to the outer metal cabinet. While the current produced may not be enough to trip existing electrical safety devices (e.g., fuses or circuit breakers), the current can be enough to cause an electrical shock hazard that could cause personal injury or death.

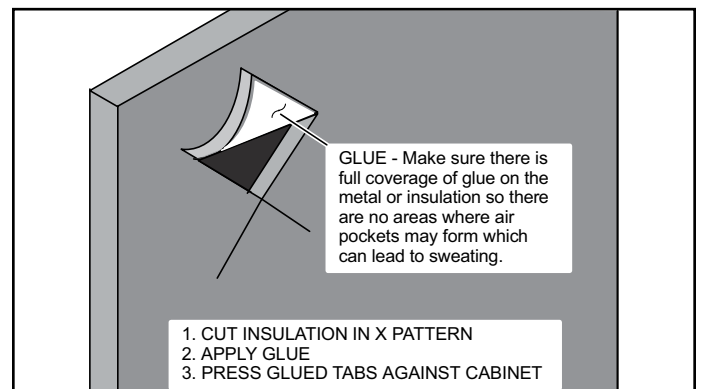

Figure 12. Repairing Insulation

Check-out Procedures

IMPORTANT

During installation, service or maintenance, make sure that copper tubing does not rub against metal edges or other copper tubing. Care should also be taken to ensure that tubing does not become kinked. Use wire ties to secure tubing to prevent movement.

Do not secure electrical wires to tubing that carries hot refrigerant gas. Heat from the tubing may melt the wiring insulation, causing a short circuit.

NOTE: Refer to outdoor unit installation instructions for system start-up instructions and refrigerant charging instructions.

Pre-Start-Up Checks

- Is the air handler properly and securely installed?
- If horizontally configured, is the unit sloped up to 1/4 inch toward drain lines?
- Will the unit be accessible for servicing?
- Has an auxiliary pan been provided under the unit with separate drain for units installed above a finished ceiling or in any installation where condensate overflow could cause damage?
- Have ALL unused drain pan ports been properly plugged?
- Has the condensate line been properly sized, run, trapped, pitched, and tested?
- Is the duct system correctly sized, run, sealed, and insulated?
- Have all cabinet openings and wiring been sealed?
- Is the indoor coil factory-installed TXV properly sized for the outdoor unit being used?
- Have all unused parts and packaging been disposed of?
- Is the filter clean, in place, and of adequate size?
- Is the wiring neat, correct, and in accordance with the wiring diagram?
- Is the unit properly grounded and protected (fused)?
- Is the thermostat correctly wired and in a good location?
- Are all access panels in place and secure?

Check Blower Operation

- Set thermostat to FAN ON.
- The indoor blower should come on.

Check Cooling Operation

- Set thermostat to force a call for cooling (approximately 5°F lower than the indoor ambient temperature).
- The outdoor unit should come on immediately and the indoor blower should start between 30 - 60 seconds later.
- Check the air flow from a register to confirm that the system is moving cooled air.
- Set the thermostat 5°F higher than the indoor temperature. The indoor blower and outdoor unit should cycle off.

Check Electric Heat (If Used)

- Set thermostat to call for auxiliary heat (approximately 5°F above ambient temperature). The indoor blower and auxiliary heat should come on together. Allow a minimum of 3 minutes for all sequencers to cycle on.
- Set the thermostat so that it does not call for heat. Allow up to 5 minutes for all sequencers to cycle off.

Installing Contractor's Name _____ Installing Date _____
 Installing Contractor's Phone _____ Air Handler Model # _____
 Job Address _____

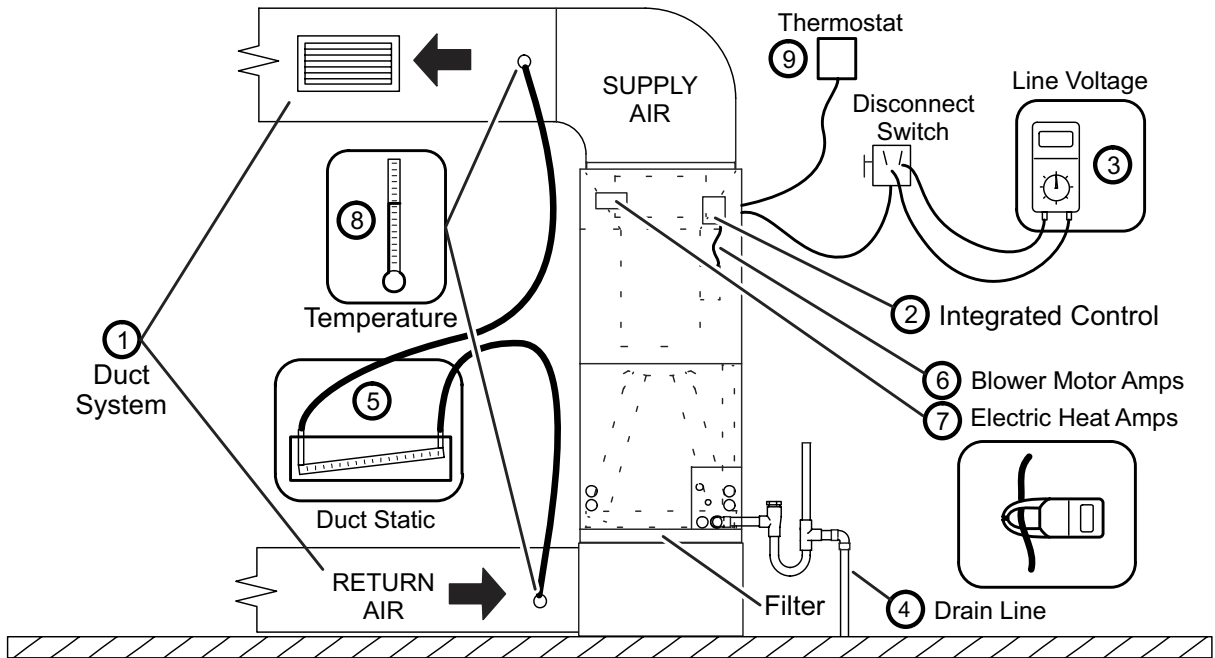

- | | |
|---|---|
| <p>① DUCT SYSTEM</p> <p>SUPPLY AIR DUCT</p> <p><input type="checkbox"/> Sealed</p> <p><input type="checkbox"/> Insulated (if necessary)</p> <p><input type="checkbox"/> Registers Open and Unobstructed</p> <p>RETURN AIR DUCT</p> <p><input type="checkbox"/> Sealed</p> <p><input type="checkbox"/> Filter Installed and Clean</p> <p><input type="checkbox"/> Registers Open and Unobstructed</p> <p>② INTEGRATED CONTROL</p> <p><input type="checkbox"/> Jumpers Configured Correctly (if applicable)</p> <p><input type="checkbox"/> Appropriate Links in Place (if applicable)</p> <p>③ VOLTAGE CHECK</p> <p><input type="checkbox"/> Supply Voltage _____</p> <p><input type="checkbox"/> Low Voltage _____</p> <p><input type="checkbox"/> Electrical Connections Tight</p> <p>④ DRAIN LINE</p> <p><input type="checkbox"/> Leak Free</p>
<p><input type="checkbox"/> Explained Operation of System to Homeowner</p> | <p>⑤ TOTAL EXTERNAL STATIC (dry coil)</p> <p style="text-align: right;">dry coil wet coil</p> <p>Supply External Static _____</p> <p>Return External Static _____</p> <p>Total External Static = _____</p> <p>⑥ ELECTRIC HEAT AMPS _____</p> <p>⑦ INDOOR BLOWER AMPS _____</p> <p>INDOOR BLOWER CFM _____</p> <p>⑧ TEMPERATURE DROP (Cooling Mode)</p> <p>Return Duct Temperature _____</p> <p>Supply Duct Temperature - _____</p> <p>Temperature Drop = _____</p> <p>⑧ TEMPERATURE RISE (Heating Mode)</p> <p>Return Duct Temperature _____</p> <p>Supply Duct Temperature - _____</p> <p>Temperature Rise = _____</p> <p>⑨ THERMOSTAT</p> <p><input type="checkbox"/> Adjusted and Programmed</p> <p><input type="checkbox"/> Operation Explained to Owner</p> |
|---|---|

Technician's Name: _____ Date Start-Up & Performance Check Completed _____

Figure 13. Start-Up and Performance Checklist (Upflow Configuration)

Installing Contractor's Name _____ Installing Date _____
 Installing Contractor's Phone _____ Air Handler Model # _____
 Job Address _____

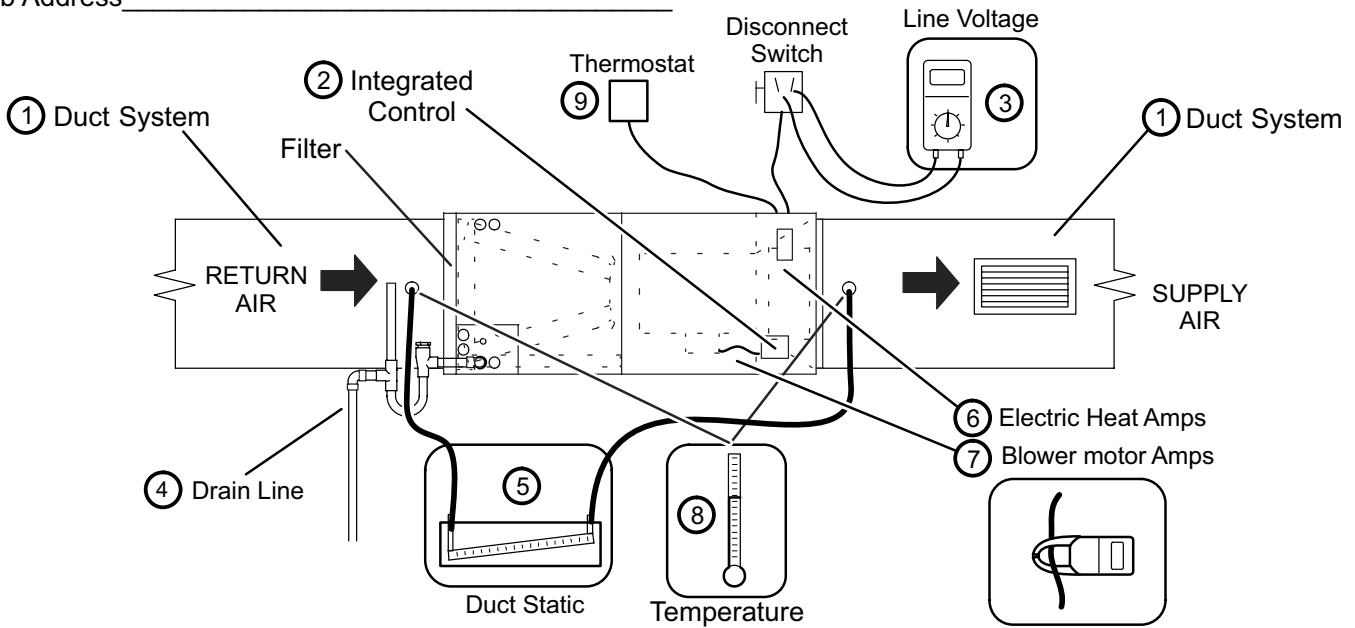

- | | |
|--|---|
| <p>1 DUCT SYSTEM</p> <p>SUPPLY AIR DUCT</p> <p><input type="checkbox"/> Sealed</p> <p><input type="checkbox"/> Insulated (if necessary)</p> <p><input type="checkbox"/> Registers Open and Unobstructed</p> <p>RETURN AIR DUCT</p> <p><input type="checkbox"/> Sealed</p> <p><input type="checkbox"/> Filter Installed and Clean</p> <p><input type="checkbox"/> Registers Open and Unobstructed</p> <p>2 INTEGRATED CONTROL</p> <p><input type="checkbox"/> Jumpers Configured Correctly (if applicable)</p> <p><input type="checkbox"/> Appropriate Links in Place (if applicable)</p> <p>3 VOLTAGE CHECK</p> <p><input type="checkbox"/> Supply Voltage _____</p> <p><input type="checkbox"/> Low Voltage _____</p> <p><input type="checkbox"/> Electrical Connections Tight</p> <p>4 DRAIN LINE</p> <p><input type="checkbox"/> Leak Free</p> <p><input type="checkbox"/> Explained Operation of System to Homeowner</p> | <p>5 TOTAL EXTERNAL STATIC (dry coil)</p> <p style="text-align: right;">dry coil wet coil</p> <p>Supply External Static _____</p> <p>Return External Static _____</p> <p>Total External Static = _____</p> <p>6 ELECTRIC HEAT AMPS _____</p> <p>7 INDOOR BLOWER AMPS _____</p> <p>INDOOR BLOWER CFM _____</p> <p>8 TEMPERATURE DROP (Cooling Mode)</p> <p>Return Duct Temperature _____</p> <p>Supply Duct Temperature - _____</p> <p>Temperature Drop = _____</p> <p>8 TEMPERATURE RISE (Heating Mode)</p> <p>Return Duct Temperature _____</p> <p>Supply Duct Temperature - _____</p> <p>Temperature Rise = _____</p> <p>9 THERMOSTAT</p> <p><input type="checkbox"/> Adjusted and Programmed</p> <p><input type="checkbox"/> Operation Explained to Owner</p> |
|--|---|

Technician's Name: _____ Date Start-Up & Performance Check Completed _____

Figure 14. Start-Up and Performance Checklist (Horizontal Configuration)