

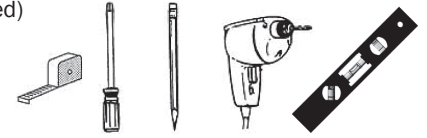

Tools Needed for Installation (not included):

- Tape Measure
- Phillips screwdriver
- Pencil
- Drill with 3/16" drill bit to pre-drill for plastic expansion anchors
- Level (recommended)



End Bracket Installation

1. Locate all brackets and correct anchors for your wall type.

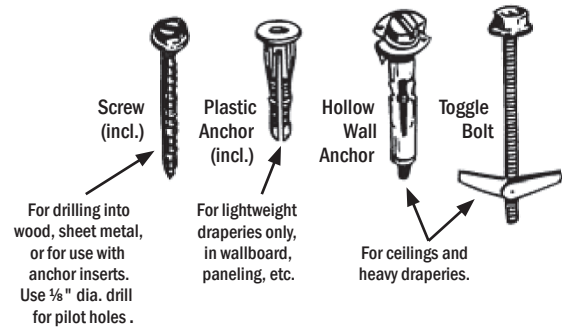

Decorative Rods - 1 1/8"

Thank you for purchasing your new decorative rods. With proper installation and care, they will provide you with many years of beauty and trouble-free use. Clean with a soft cloth. Do not use harsh or abrasive cleaning supplies or polishes which may damage the finish.

Hardware Components Recommended for Pole purchased

- Suggested support brackets

| Rod Width | # of Brackets | Description |
|------------|---------------|---------------------------------------|
| 0 - 4 ft. | 2 | Two end brackets |
| 4 - 6 ft. | 3 | One center support, two end brackets |
| 6 - 8 ft. | 4 | Two center supports, two end brackets |
| 8 - 12 ft. | 4 | Two center supports, two end brackets |

Maximum panel weight for support brackets

| Rod Width | # of Brackets | One Way Draw Panel Weight | Center Draw Panel Weight |
|------------|---------------|---------------------------|--------------------------|
| 0 - 4 ft. | 2 | 4.0 lb/ft | 4.0 lb/ft |
| 4 - 6 ft. | 3 | 4.0 lb/ft | 4.0 lb/ft |
| 6 - 8 ft. | 4 | 4.0 lb/ft | 4.0 lb/ft |
| 8 - 12 ft. | 4 | 3.0 lb/ft | 4.0 lb/ft |

NOTE: 8 ft. rod width center draw can be supported with: One center support, two end brackets

Double turned bracket:

- Maximum panel weight per cup is 2.5 lb/ft
- Pole length not to exceed 6 ft.

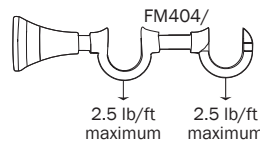

Orbital, Long Turned Bracket and V-Brackets:

- Maximum panel weight:
 - 0 - 6 ft. pole is 3.0 lb/ft.
 - 6 - 12 ft. pole is 2.0 lb/ft.

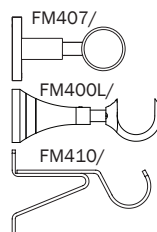

- Screws and plastic anchors
- Finials (sold separately)

Begin with the two outside end brackets. Determine the desired height and width based on the drapery measurements. Be certain to make the appropriate allowance for the decorative hardware. It is recommended that the brackets be installed approximately 2" - 4" beyond the window frame (see illus 1A).

2. Once the bracket position is determined, remove the round silver mounting base by unscrewing it from the back of the bracket and use it as a guide to mark the location on the wall for the anchors or screws (see illus 1B).

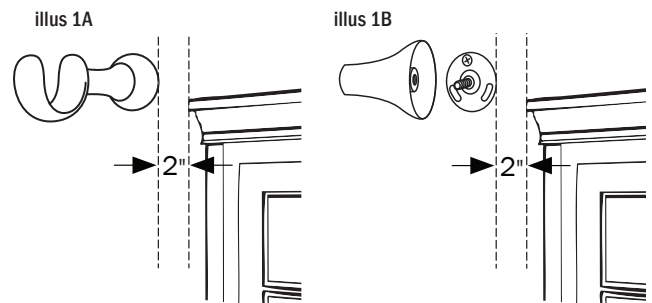

3. If using plastic expansion anchors, pre-drill holes using 3/16" drill bit. If drilling directly into a stud or wood trim, pre-drill holes with 3/32" drill bit. Attach the bracket mounting base using the screws provided.
4. Screw on the decorative portion of the bracket to the mounting base until it is tight and the open side of bracket faces up to the ceiling. If the cup does not end facing up, loosen the screw to adjust.

Tips for Successful Installation

Securely attach all brackets to the mounting surface. If you do not locate and install into wood studs, use the proper wall fasteners and / or plastic anchors designed for your particular mounting surface (screws and plastic anchors are included). When drilling into metal, use self-tapping screws (not included).
Make certain all brackets line up evenly by measuring their placement.

Center Bracket Installation

5. When center supports are required, be certain to install the center brackets level with the outside brackets. Follow the same instructions as end brackets above.
6. When using one center support, place it at the center of the window between the two end brackets. When using two center supports, install them an equal distance apart between the two end brackets. If using two center supports, the draperies will not be functional. Rings or grommets cannot pass through or over support brackets.

Finials, Rings and Pole Attachment:

7. If using rings, slide the appropriate number onto the pole, or slide the drapery treatment directly onto the pole.

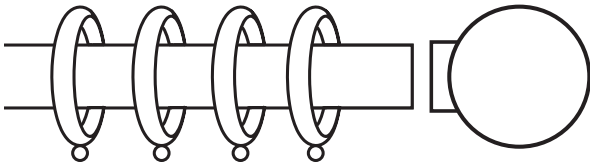

8. Attach the finials to the pole and tighten the set screws with the Allen Wrench provided on the finial base by hand to complete the finial installation. **NOTE:** Some finials may have an inset screw in order to tighten it to the pole. For those designs, use the Allen Wrench provided with those finials.
9. Place the pole onto the mounting brackets. The pole should extend 1" - 2" past each end bracket. The last ring or grommet should be placed on the outside end of the end brackets.

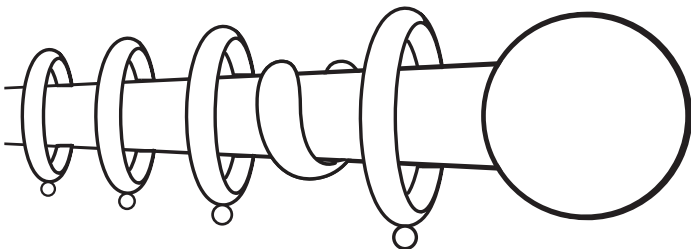

10. Tighten the set screws on the brackets with the Allen Wrench provided to lock the pole into place. **NOTE:** The mounting brackets can be adjusted to provide a 3 1/2" to 5 1/2" projection from the wall to allow for the appropriate size drapery return. Hang the draperies onto the pole / rings as required by the style ordered.