



**Submittal Data:**

**ETAC2 With Universal Heater - 7,000 to 15,000 Cooling w/ Electric Heating Models (Power Cord Required)**

**208/230 & 265 Voltage**

Job Name	Location	Date
Purchaser	Engineer	Phone
Submitted To	For <input type="checkbox"/> Reference <input type="checkbox"/> Approval <input type="checkbox"/> New Construction <input type="checkbox"/> Revovation Project	
Unit Designation	Schedule No.	

**GENERAL FEATURES**

- Industry Standard Size 42" x 16" - Designed to easily install in most standard wall sleeve (Contractor must verify)
- Electronic Touch Pad
- IR Remote Control (Optional)
- Wired, Wireless Wall Thermostat & Energy Management System Interface
- LCDI Power Cord (208/230V Only)
- Condensate Slinger Ring Disposal
- Dry Mode
- Industry's Longest Standard Warranty (See Product Catalog For Details)



**Performance Specification**

Model Number	Capacity (BTU/H)				Dehumi - dification (Pints/Hr)	Energy Efficiency Ratio (EER)	Sensible Heat Factor	Indoor Fan CFM (Hi/Low)	AHRI Certification Number
	Cooling	Universal Electric Heating							
		2.45 KW	3.45 KW	5.0 KW					
<b>208/230 Volt</b>									
ETAC2-07HC230VA-A	7,000/7,200	6,800/8,300	9,600/11,700	-	1.69	13.0	86%	312/282	8703480, 8703481
ETAC2-09HC230VA-A	9,200/9,400	6,800/8,300	9,600/11,700	13,900/17,000	2.11	12.1	85%	329/294	8703482, 8703483, 8703484
ETAC2-12HC230VA-A	11,600/11,800	6,800/8,300	9,600/11,700	13,900/17,000	2.75	11.6	75%	341/306	8703485, 8703486, 8703487
ETAC2-15HC230VA-A	14,200/14,500	6,800/8,300	9,600/11,700	13,900/17,000	3.17	10.4	67%	341/306	8703488, 8703489, 8703490
<b>265 Volt</b>									
ETAC2-07HC265VA-A	7,200	8,300	11,700	-	1.69	13.0	86%	312/282	
ETAC2-09HC265VA-A	9,400	8,300	11,700	17,000	2.11	12.1	85%	329/294	
ETAC2-12HC265VA-A	11,800	8,300	11,700	17,000	2.75	11.6	75%	341/306	
ETAC2-15HC265VA-A	14,500	8,300	11,700	17,000	3.17	10.4	67%	341/306	

**Electrical Specification**

Model Number	Voltage	Input Power (Watts)				Current (Amps)				Max Fuse Size (Amps) (Based on Power Cord Selection)
		Cooling	Universal Electric Heating			Cooling	Universal Electric Heating			
			2.45 KW	3.45 KW	5.0 KW		2.45 KW	3.45 KW	5.0 KW	
<b>208/230 Volt</b>										
ETAC2-07HC230VA-A	208/230	535/550	2,003/2,450	2,821/3,450	-	2.9/2.7	9.7/10.7	13.6/15.0	-	15, 20
ETAC2-09HC230VA-A	208/230	760/775	2,003/2,450	2,821/3,450	4,089/5,000	3.9/3.7	9.7/10.7	13.6/15.0	19.7/21.8	15, 20
ETAC2-12HC230VA-A	208/230	1,000/1,015	2,003/2,450	2,821/3,450	4,089/5,000	5.1/4.9	9.7/10.7	13.6/15.0	19.7/21.8	15, 20, 30
ETAC2-15HC230VA-A	208/230	1,365/1,390	2,003/2,450	2,821/3,450	4,089/5,000	6.7/6.2	9.7/10.7	13.6/15.0	19.7/21.8	15, 20, 30
<b>265 Volt</b>										
ETAC2-07HC265VA-A	265	550	2,450	3,450	-	2.4	9.3	13.1	-	15, 20
ETAC2-09HC265VA-A	265	775	2,450	3,450	5,000	3.3	9.3	13.1	18.9	15, 20
ETAC2-12HC265VA-A	265	1,015	2,450	3,450	5,000	4.2	9.3	13.1	18.9	15, 20, 30
ETAC2-15HC265VA-A	265	1,390	2,450	3,450	5,000	5.4	9.3	13.1	18.9	15, 20, 30



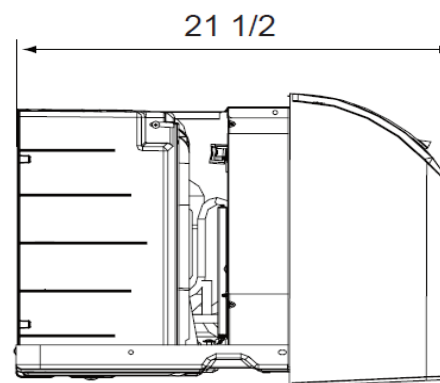
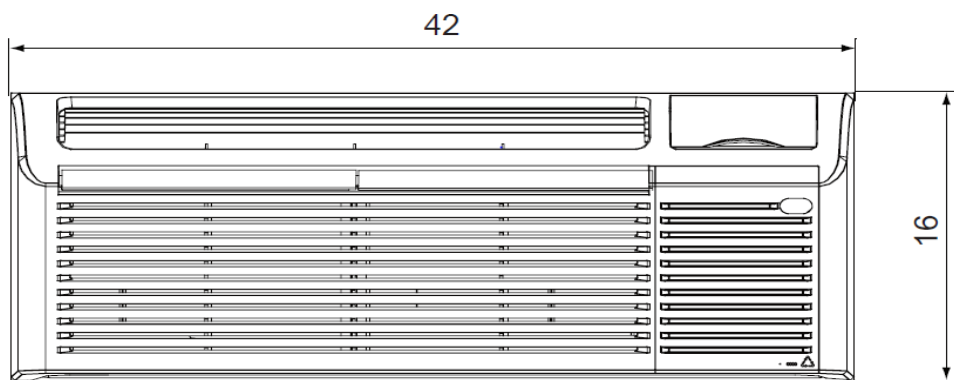



## Dimensional Specifications



## Universal Power Cord Selection

Model Number	Voltage	Breaker Size	Electric Heater KW	Minimum Circuit Ampacity	Receptacles Type	NEMA Number
E2CORD-230V15A	208/203	15	2.45	14	Tandem	6-15P
E2CORD-230V20A	208/203	20	3.45	19	Perpendicular	6-20P
E2CORD-230V30A	208/203	30	5.0	28	Large Tandem	6-30P
E2CORD-265V15A	265	15	2.45	12	265V 15 Amp	7-15P
E2CORD-265V20A	265	20	3.45	17	265V 20 Amp	7-20P
E2CORD-265V30A	265	30	5.0	24	265V 30 Amp	7-30P

## Receptacle Configuration

208/230V	265V
	
Tandem 208/230V 15 Amp NEMA6-15R	265V 15 Amp NEMA7-15R
	
Perpendicular 208/230V 20 Amp NEMA6-20R	265V 20 Amp NEMA7-20R
	
Large Tandem 208/230V 30 Amp NEMA6-30R	265V 30 Amp NEMA7-30R

## Accessories

PTAC-SLEEVE-SE-INS	Standard Sleeve Metal Insulated
WALL-SLEEVE-1PK	Standard Wall Sleeve Polymer Non-Insulated
SLEEVE-INSUL-1PK	Standard Wall Sleeve Polymer Insulated
PTAC-SUBBASE-A	Non-Electrical Subbase [Electrical Components Available]
GRILLE-ALU-CLEAR	Aluminum Architectural Louvered Grille - Clear [Additional Colors Available]
GRILLE-PLA-ALPIN	Polymer Architectural Louvered Grille - Alpine Beige (matches wall sleeve) [Additional Colors Available]
GRILLE-ALU-STAMP	Stamped Aluminum Grille - Clear
DRAIN-KIT-1PK	Internal & External Drain Kits
TP-N-631W	Wireless Wall Thermostats 2 Fan Speed (Non-Programmable)
TP-N-631	Wired Wall Thermostats 2 Fan Speed (Non-Programmable)

Please refer to ETAC2 product catalog for complete line of accessories



www.gree-etac.com  
1-866-239-4440