

208/230V Subbase Receptacle Accessory Kit For Use With Packaged Terminal Air Conditioner

Installation Instructions

INTRODUCTION

These instructions cover the installation of the 208/230V Subbase Receptacle Accessory Kit for a non-electrical subbase.

SAFETY CONSIDERATIONS

Installing and servicing air-conditioning equipment can be hazardous due to system pressures and electrical components. Only trained and qualified personnel should install or service air-conditioning equipment. When working on air-conditioning equipment, observe the precautions provided in literature, tags, and labels attached to the unit.

Follow all safety codes. Wear safety glasses, protective clothing, and work gloves. Use quenching cloth for brazing operations. Have fire extinguisher available. Read these instructions thoroughly and follow all warnings or cautions included in literature and attached to the unit. Consult local building codes and current editions of the National Electrical Code (NEC) NFPA 70. In Canada, refer to current editions of the Canadian electrical code CSA 22.1.

Recognize safety information. This is the safety-alert symbol . When you see this symbol on the unit and in instructions or manuals, be alert to the potential for personal injury.

Understand these signal words: DANGER, WARNING, and CAUTION. These words are used with the safety-alert symbol. DANGER identifies the most serious hazards which will result in severe personal injury or death. WARNING signifies hazards which could result in personal injury or death. CAUTION is used to identify unsafe practices which may result in minor personal injury or product and property damage. NOTE is used to highlight suggestions which will result in enhanced installation, reliability, or operation.

PACKAGE CONTENTS

ITEMS	QUANTITY
208/230V Receptacle	1
Receptacle Junction Box	1
Receptacle Cover (inc Screws)	1
Attachment Screws (Junction Box)	4
Attachment Screws (Receptacle)	2

FIELD SUPPLIED MATERIAL REQUIRED

ITEMS
Power Source Conduit and Wire Nuts
Grounding Screw or Clip
Ground Wire

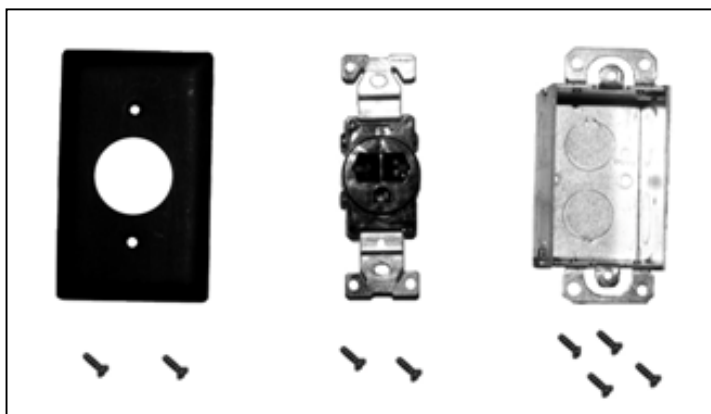

Figure 1 – Package Contents

GENERAL

The 208/230V Subbase Receptacle Accessory Kit can be field installed to convert a non-electrical subbase, to an electrical subbase with a receptacle, for corded packaged terminal air conditioner (PTAC) units. See Fig. 2.

The 208/230v Subbase Receptacle Accessory Kit is available with 15, 20 or 30 amp ratings.

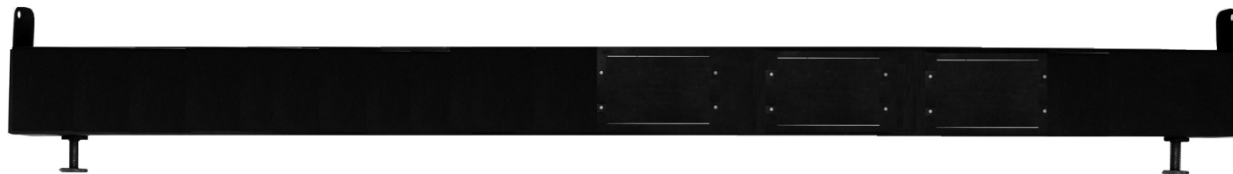



Figure 2 – Non-Electric Subbase

INSTALLATION

⚠ WARNING

- **Installation requires understanding and use of good electrical practices, it is recommended that installation of the receptacle kit is done by a qualified electrician.**
- **For personal safety, this accessory MUST BE properly grounded.**
- **Refer to chassis nameplate for power source requirements.**
- **Be sure that the receptacle matches cord configuration on unit.**



Mechanical Assembly

NOTES:

- ***IF SWITCH KIT OR FUSE-KIT Accessories will also be installed, refer to those installation instructions first.***
- *IF subbase is already installed on PTAC unit, remove to simplify installation of receptacle kit accessory.*

Step 1 — Disconnect all power to the unit.

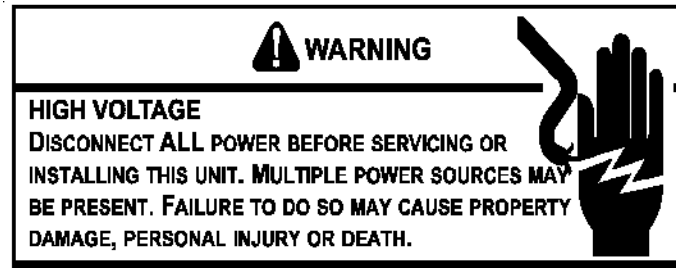

Step 2 — Remove knockout "A" from non-electrical subbase as shown in figure 3.

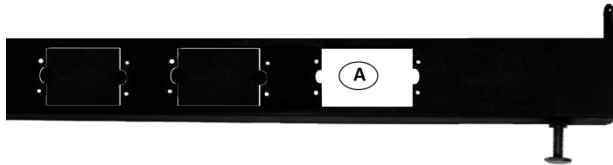

Figure 3 – Knockout A in Subbase

Step 3 — Remove knockout "1" from one side of the "Receptacle" junction box as shown in Figure 4.

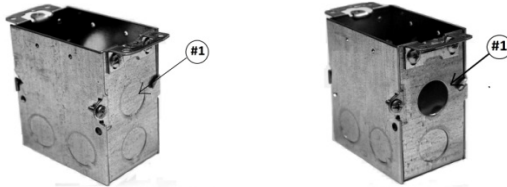

Figure 4 – Junction Box Knockout

Step 4 — Insert "Receptacle" junction box into subbase hole "A" and secure with factory supplied screws as shown in figure 5.

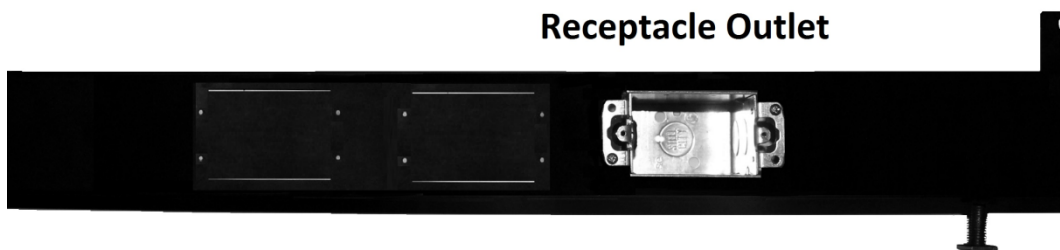

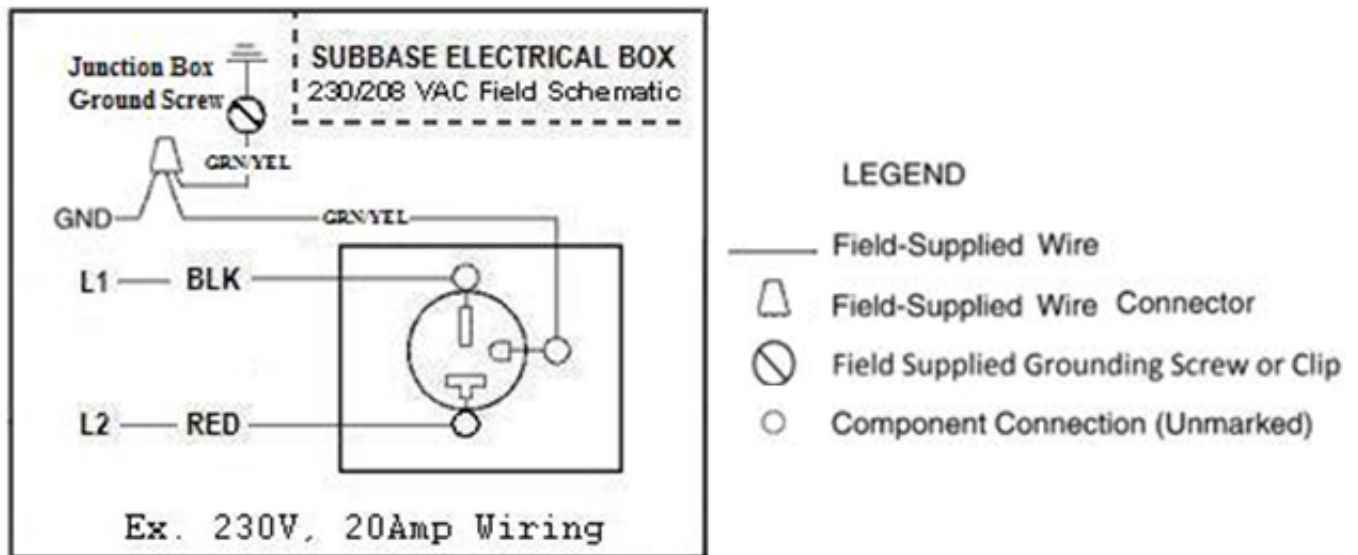

Figure 5 – Junction Box Installed

Wiring Assembly

 WARNING	
HIGH VOLTAGE DISCONNECT ALL POWER BEFORE SERVICING OR INSTALLING THIS UNIT. MULTIPLE POWER SOURCES MAY BE PRESENT. FAILURE TO DO SO MAY CAUSE PROPERTY DAMAGE, PERSONAL INJURY OR DEATH.	

SCHEMATIC



 CAUTION
TO AVOID THE RISK OF PROPERTY DAMAGE, PERSONAL INJURY OR FIRE, USE ONLY COPPER CONDUCTORS.

Figure 6 – Wiring Diagram

Step 5 — Attach field supplied conduit (from power source), to knockout hole “1” on “Receptacle” junction box. Using field supplied conduit nuts, tighten conduit to “Receptacle” junction box as shown in figure 7.



Figure 7 – Attach Conduit to Junction Box

 **CAUTION**

TO AVOID THE RISK OF PERSONAL INJURY, WIRING TO THE UNIT MUST BE PROPERLY POLARIZED AND GROUNDED.

Step 6 — Connect Power Source wiring to “Receptacle” as shown in figure 8. Power source wiring and receptacle must be properly grounded to the “Receptacle” Junction Box using a field supplied ground wire and grounding screw or clip. Refer to wiring diagram in Figure 6 above.

NOTE: *Terminate all Ground Wires per code and acceptable trade practices.*

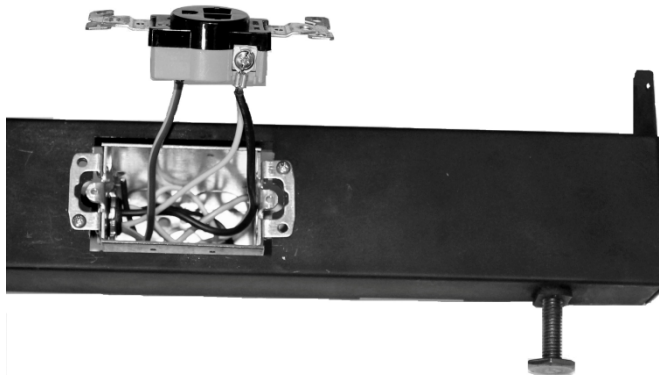

Figure 8 – Wire Power Source to Receptacle

Step 7 — Use factory supplied screws to fasten “Receptacle” to junction box on the subbase as shown in figure 9.

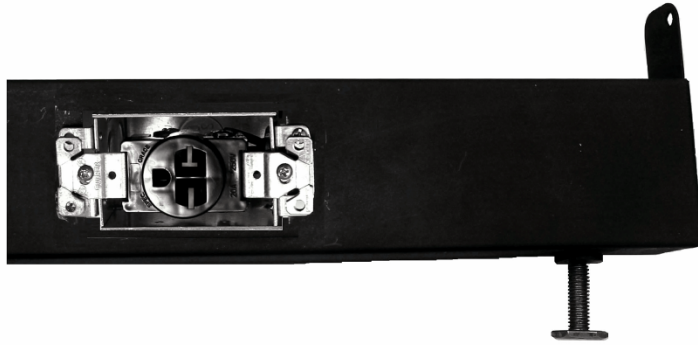

Figure 9 – Fasten Receptacle to Junction Box

Step 8 — Use factory supplied screws to fasten “Receptacle” cover plate to Receptacle on the subbase as shown in figure 10.

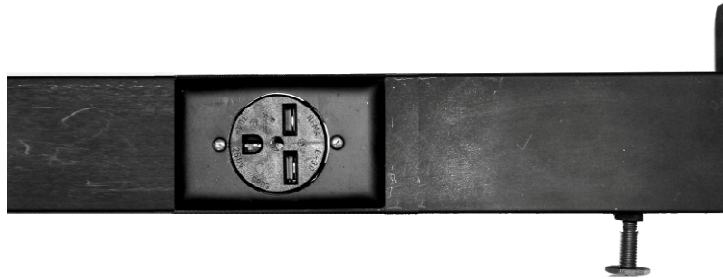

Figure 10 – Install Receptacle Cover

Step 9 — Install subbase on PTAC wall sleeve per the installation instructions for a non electric subbase. See figure 11 for a completed installation.

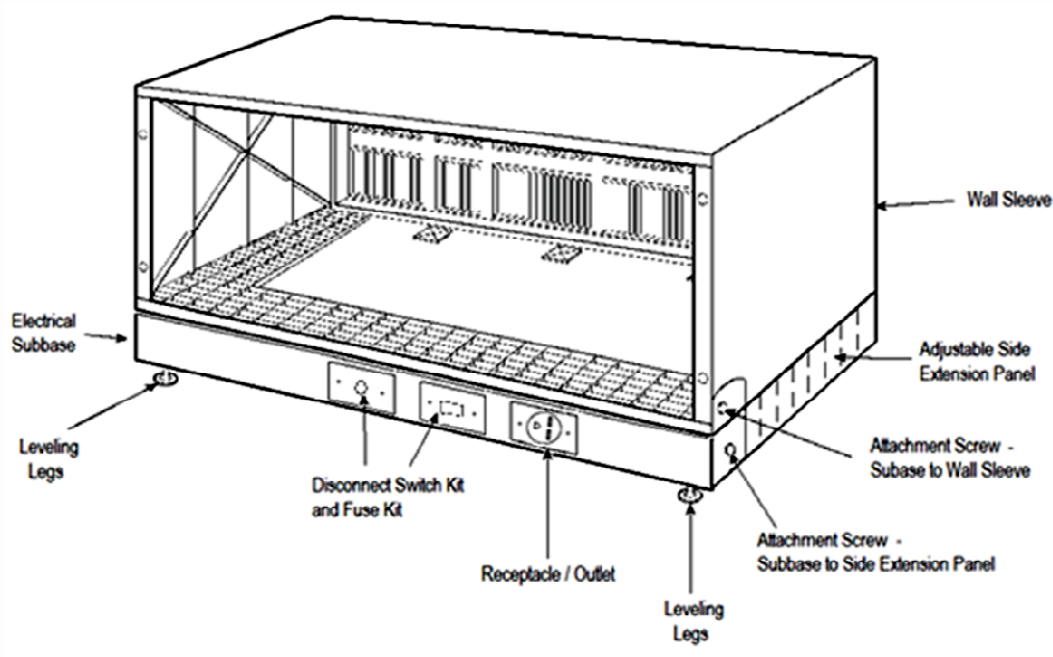

Figure 11 – Attach Subbase to Wall Sleeve