

# Installation Instructions



Fig. 1 - Narrow Vertical ERV (ERVNVA)

A13274



Fig. 2 - ERVNVA Internal View

A13275

## SAFETY CONSIDERATIONS

Improper installation, adjustment, alteration, service, maintenance, or use can cause explosion, fire, electrical shock, or other conditions which may cause death, personal injury or property damage. Consult a qualified installer, service agency, or your distributor or branch for information or assistance. The qualified installer or agency must use factory-authorized kits or accessories when modifying this product. Refer to the individual instructions packaged with kits or accessories when installing.

Follow all safety codes. Wear safety glasses, protective clothing and work gloves. Have a fire extinguisher available. Read these instructions thoroughly and follow all warnings or cautions included in literature and attached to the unit. Consult local building codes and the current editions of the National Electrical Code (NEC) NFPA 70.

Recognize safety information. This is the safety-alert symbol . When you see this symbol on the unit and in instruction manuals, be alert to the potential for personal injury.

Understand the signal words **DANGER**, **WARNING**, and **CAUTION**. These words are used with the safety-alert symbol. **DANGER** identifies the most serious hazards which **will** result in severe personal injury or death. **WARNING** signifies hazards which **could** result in personal injury or death. **CAUTION** is used to identify unsafe practices which **may** result in minor personal injury or product and property damage. **NOTE** is used to highlight suggestions which will result in enhanced installation, reliability, or operation.

## APPLICATION NOTE

This ERV does not contain a defrost function. Installations of this product are limited to IECC Climate Zones 1-5. (See Fig. 3.)

The unit is not to be installed in Climate Zones 6 or higher.

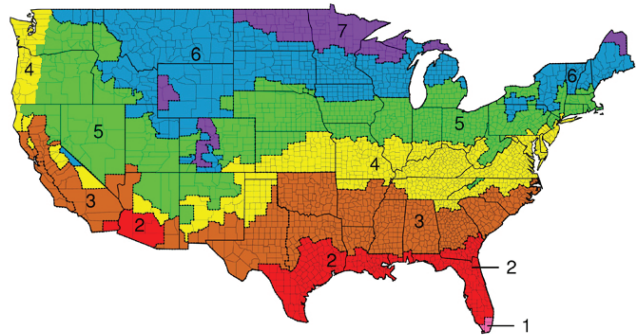

Fig. 3 - IECC Climate Zone Map

A13276

**NOTE:** Read the entire instruction manual before starting the installation.

## NOTE TO ENERGY RATERS

HVI rated performance of this ERV is not representative of the actual CFM/watt performance in the actual application due to test protocol of the laboratory rating test. Actual ERV CFM/watt performance with the triangular openings connected to a location under negative static pressure will significantly improve. For example at medium speed with the connection location at -0.2-in. w.c. and with +0.1-in. w.c. duct connection static, a typical measurement is 1.14 CFM/watt. For additional performance data points more representative of actual application, refer to Table 2 on Page 6.

## INTRODUCTION

The NV (Narrow Vertical) Energy Recovery Ventilator (ERV) is used to exchange indoor stale air with outside fresh air. The unit is equipped with a special energy recovery core which transfers both sensible (temperature) and latent (moisture) heat between the fresh incoming air and stale exhaust air. The cross-flow design core allows entering and leaving air streams to transfer heat and latent energy without mixing. (See Fig. 4.)

The unit is designed to fit in tight installation spaces, and requires no wall control. The power hook up for the ERV wires directly to the furnace control EAC terminals and is designed to run whenever the furnace blower is running. Once the ERV blower speed is selected at installation, based on the amount of ventilation air required, the main system wall control becomes the ventilation control. In order to meet required ventilation airflows, it is recommended that the furnace blower run in a low speed continuous operation mode at all times.



Fig. 4 - Airflow During Air Exchange

A13277

The model operates at three nominal airflows, 70, 110 and 135 CFM in low, medium and high speed respectively. (See Tables 2-6 for actual airflow values.) Special attention should be given to duct application and locating unit for easy access and routine maintenance.

## INSTALLATION

### Select Mounting Location

The Model ERVXXNVA1090 is designed to be installed on the return duct/plenum or directly to the furnace cabinet. The exhaust inlet and supply outlet connections (i.e. triangular openings at the bottom of the cabinet) must be installed at a location that will be in negative pressure when the furnace blower is running. (There are two triangular cutouts on each side of the cabinet so the unit can be mounted to either the left or right side of the duct or furnace cabinet.)

Block-off plates are included, and must be in place to cover the ports not used.

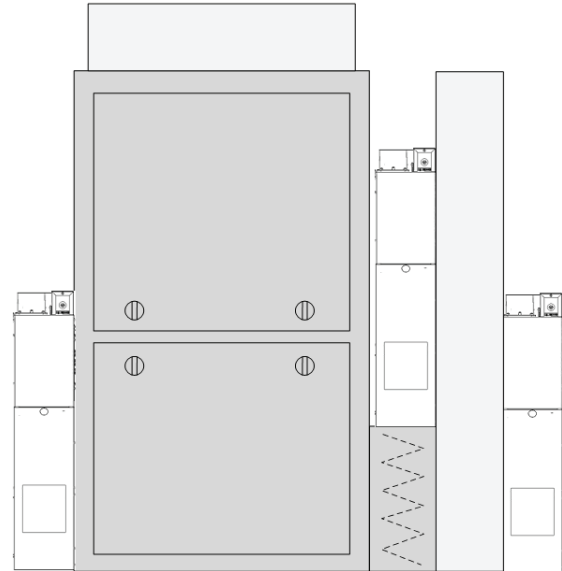

A13278

Fig. 5 - Typical Mounting Locations for Furnace Applications

NOTE: For other installation mounting options, see Fig. 18 .

When used with a furnace, triangular cutouts can be made in the return-air opening areas of the furnace cabinet.

When the ERV is used with a fan coil, the ERV is mounted on the duct. **Do not cut openings in the fan coil.** For fan coil installation mounting options, see Fig. 19 .

## ⚠ CAUTION

### UNIT DAMAGE HAZARD

Failure to follow this caution may result in equipment damage or improper operation.

Do not install ERV directly on the side of fan coil units. Do not cut openings in the fan coil cabinet.

There should be adequate space (at least 18-3/8-in.) in front of the unit for door, filter and core removal. Mount the ERV close enough to the furnace that the power cord will reach to the EAC terminals of the furnace circuit board.

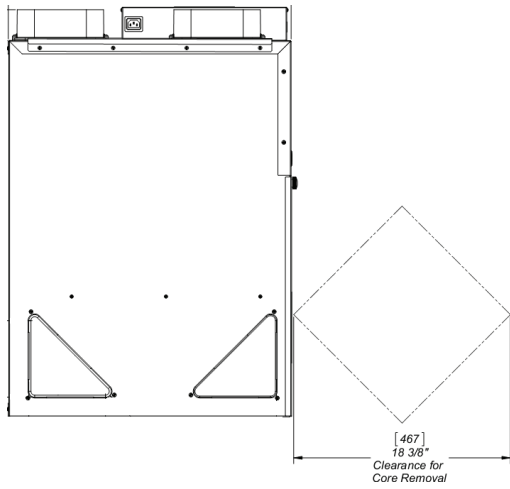

**Fig. 6 - Clearance for Service**

A13279

### ERV Cabinet Installation

**NOTE:** If installing the ERV to duct board, a sheet metal plate or “skin” should be first applied to the area where the triangular ERV openings will be located. The triangular openings may be pre cut in the sheet metal plate as desired.

- Turn off power to the furnace or fan coil.
- Remove the ERV door and then remove the filters and core. Place these items in a safe location to prevent damage during the rest of the installation process.

**NOTE:** Make sure that the pull ring on the core is turned upward away from the front core corner and flat against the face of the core, and that the filters are fully seated and locked before replacing the door.

## ⚠ WARNING

### ELECTRICAL SHOCK HAZARD

Failure to follow this warning could result in personal injury or death.

Before installing or servicing system, always turn off main power to system. There may be more than one disconnect switch.

## ⚠ CAUTION

### CUT HAZARD

Failure to follow this caution may result in personal injury.

Sheet metal parts may have sharp edges or burrs. Use care and wear appropriate protective clothing and gloves when handling parts.

1. Install one of the two J-hook mounting brackets to the side of the ERV that will be facing the duct or furnace cabinet. Remove the existing screws in the top flange of the ERV housing, position the J-hook as shown and secure the J-hook by reinstalling the screws.

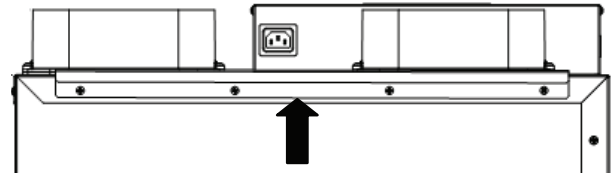

**Fig. 7 - J-Hook Installation**

A13280

2. Position the cabinet at the location where it will be installed. Hook the remaining J-hook mounting bracket into the J-hook that is installed on the ERV and use this to mark the mounting hole locations for the J-hook on the furnace or duct. Alternatively, locate the top of the J-hook 32-3/4-in. higher than where the bottom of the ERV cabinet will lie (3/4-in. higher than where the top of the ERV cabinet will lie).

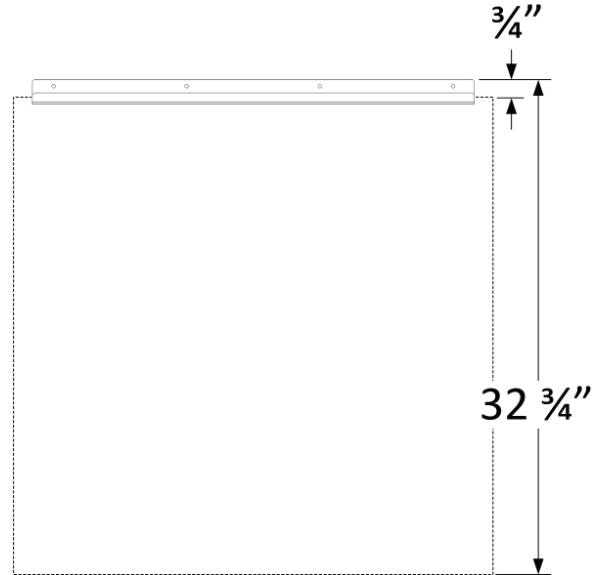

**Fig. 8 - J-Hook Position**

A13281

3. Use piercing or self-tapping #8 sheet metal screws to install the J-hook to the duct or furnace cabinet.
4. Slide the ERV cabinet onto the J-hook and position the cabinet to the desired location.

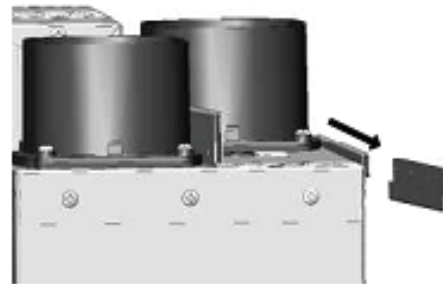

**Fig. 9 - Slide ERV onto J-Hook**

A13290

- Reaching through the triangular cutouts on the non-attached side, use a marker to trace the triangular cut out locations on the duct or furnace cabinet.

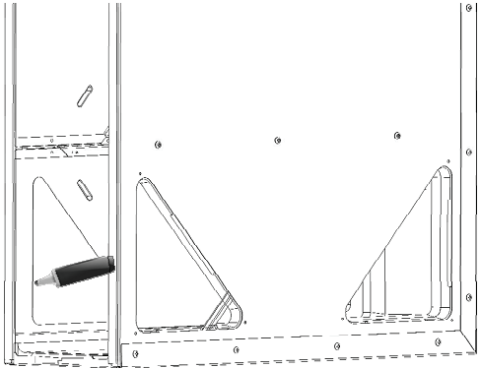

**Fig. 10 - Tracing the Cutouts**

A13282

- Set the cabinet aside and cut out the marked openings. Rounding the corners of the triangular openings is not required.
- Install the foam seals around the perimeter of each cut opening.

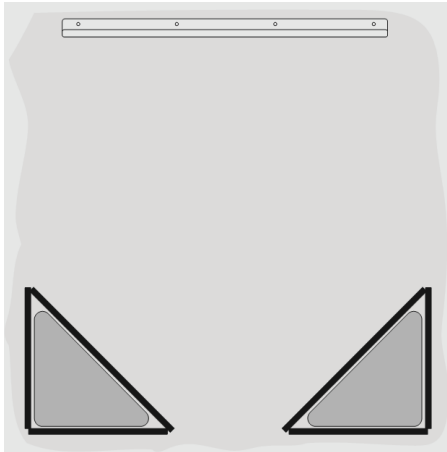
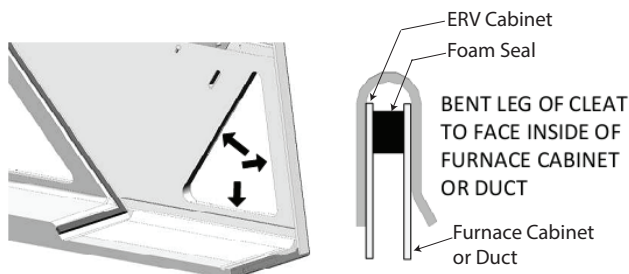

**Fig. 11 - Foam Seal Locations**

A13283

**NOTE:** Use the two longer seals for the long side of each triangle.

- Slide the cabinet into place until the triangular openings in the ERV cabinet align with the openings in the duct or furnace cabinet.
- Install three cleats in each of the triangular openings. The bent edge of the cleat should point away from the ERV cabinet. The cleats will help to secure the ERV to the duct or furnace with a tight seal.



**Fig. 12 - Cleat Attachment**

A13284

## Exhaust Baffle Installation (Furnace Cabinet Installations Only)

If the ERV is mounted directly to the furnace cabinet, the exhaust baffle provided in the carton is used to prevent short cycling the fresh-air supply to the stale-air exhaust. (If a replacement is needed, order Part No. 5429 from Replacement Components.)

Bend the baffle to match the exhaust-outlet opening shape cut into the furnace cabinet. Use a pliers or sheet metal bending pliers to get sharp corners. Bend the mounting tabs to the inside of the baffle.

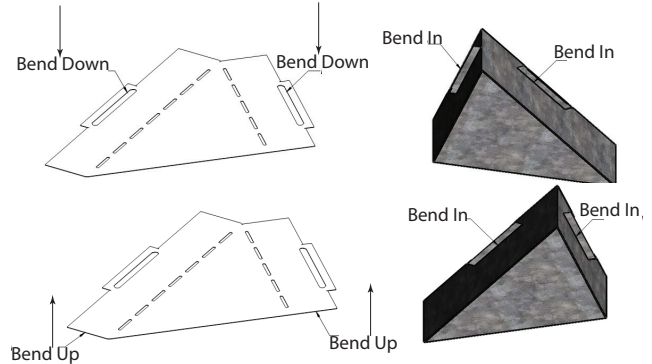

**Fig. 13 - Baffle Attachment**

A13285

Place the baffle inside the furnace cabinet, over the triangular cut-out, and install the mounting tabs into the cleats. You may have to support the cleats with your hand when pressing the baffle into place.

## Power Cord Installation & Wiring to Furnace

Remove one of the 7/8-in. diameter knockouts on the side of the furnace cabinet and remove the furnace blower door. Insert the terminal end of the power cord through the knockout. Install the black wire to the EAC-1 terminal and the white wire to the EAC-2 terminal.

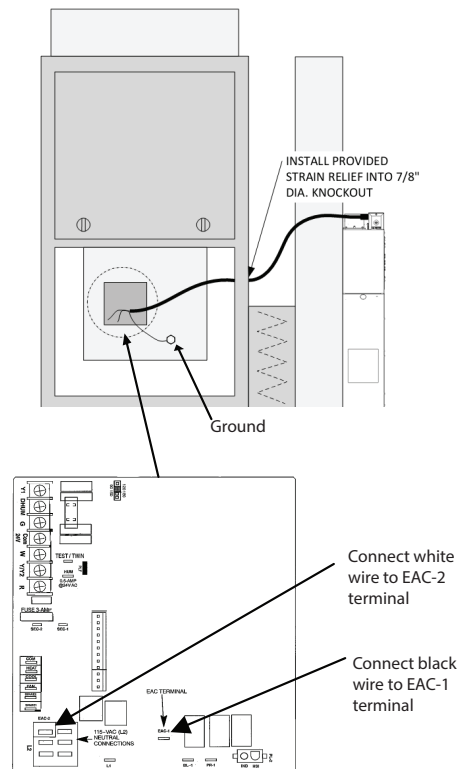

**Fig. 14 - Power Cord Installation on Furnace Board**

A13286

Install the green ground wire to the ground screw on the blower housing. Refer to the furnace installation manual for locations of the EAC-1 and EAC-2 terminals. Connect the black wire to the line voltage terminal (EAC-1) and the white wire to the line voltage – neutral terminal (EAC-2).

Plug the power cord into the receptacle of the ERV to determine how much cable to leave outside the furnace cabinet. Make sure the power cord inside the furnace cabinet cannot reach any moving part. Place the provided strain relief bushing around the wire where it enters through the knockout. Use pliers to install the bushing into the furnace cabinet and then unplug the ERV for the remainder of the installation.

### Wiring for Fan Coil Applications

When using the ERV in a fan coil application, accessory Part No. 5428 (Fan Coil Accessory Installation Kit for ERVXXNVA) is available through Replacement Components. Wiring instructions are included with the kit.

### Replace Core and Filter

Carefully replace the core into the ERV using the slide rails, with attention to the positioning label on the core. The pull tab on the core is positioned so that it is accessible from the front. Once the core is in place, rotate the pull tab toward the top/back of the core, laying it flat on the core, so that it does not interfere with filter placement or door attachment. Insert the filters. The filters have moveable tabs to hold the filters properly in place. The tabs should be positioned toward the front of the cabinet & core so that they are visible. Rotate the tabs into the slots in the insulation to hold the filter in place on the core.

### Select Locations For the Fresh-Air Intake Hood and Stale-Air Exhaust Hood

Locate the hoods:

- At least 18-in. above the ground or above the expected snow line.
- Ten feet away from dryer vents, furnace exhaust, driveways, oil fill pipes and gas meters.

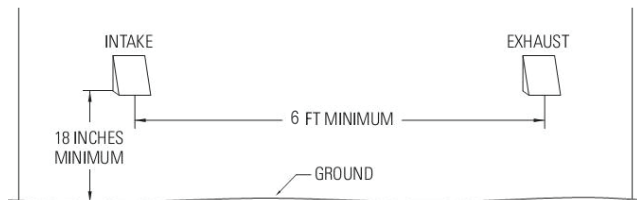

A13287

**Fig. 15 - Intake and Exhaust Hood Locations**

- Far enough from garbage containers to prevent unwanted odors from entering home.
- At a distance of six feet apart or if not possible so that the intake hood is upstream of the exhaust hood to reduce the likelihood of the stale air exhaust from entering the fresh air intake hood.
- Do not install the hoods in attics, garages or crawl spaces.

### Mount The Hoods

Install weather tight hoods with bird screens.

Cut a hole in the exterior wall that is large enough to fit 6-in. insulated flexible duct through with minimal compression of the insulation. Pull the duct through the hole and attach the flex duct to the collar of the hood. Use good quality metal duct tape and a plastic zip-tie to secure the duct to the collar. Pull the insulation and vapor barrier over the duct and tape it to the collar.

**NOTE:** The end of the insulation must be sealed to prevent condensation from forming inside the insulation. If a plastic zip-tie is used to secure the insulation to the hood collar, also tape the end to seal it against condensation problems.

Press the hood against the outside wall and secure in place with screws; seal around the perimeter of the hood with caulk.

### Install ductwork

Run 6-in. insulated flexible duct from the hoods to the ERV. Attach the Fresh Air Intake Hood to the Supply collar of the ERV, and the Exhaust Air Exhaust Hood to the Exhaust collar. To keep external static pressure to a minimum, keep duct runs as short and as straight as possible and avoid compressing the duct to “fit it” in smaller spaces. Six inch steel, straight duct can be used, but must be insulated to at least R4. A minimum of 24-in. of insulated flex duct must be used at the ERV connection to reduce noise levels.

Pull the duct over the collar and secure using good quality metal duct tape and a plastic zip-tie. Pull the insulation and vapor barrier over the duct and tape it to the collar.

**NOTE:** If a normally-closed power-open damper is desired for the fresh-air intake, order Part No. 6506C, available through Replacement Components.

### START UP

1. Assemble the door to the ERV
2. Plug the power cord into the ERV
3. Replace the door onto the furnace or fan coil
4. Restore power to the furnace or fan coil
5. Set the thermostat fan selector to FAN-AUTO, and the thermostat mode selector to OFF
6. Verify that the ERV blowers are NOT operating.
7. Set the thermostat fan selector to FAN-ON.
8. Verify that both ERV blowers are operating. When it is set for low speed (factory default setting), the ERV makes very little noise, so you may need to place your hand over the duct collars to verify flow. Do not put your hand inside the duct collar.
9. Return the thermostat to the desired Mode and Fan setting.

**NOTE:** Refer to the Maintenance and Troubleshooting section on Page 8, if needed.

### Set Desired Airflow & Balance of the ERV

#### 1. Determine Ventilation Requirements:

Ventilation requirements are generally code specific, so consult with your local code to confirm ventilation quantities. One common reference for ventilation requirements is ASHRAE Standard 62.2 – Ventilation and Acceptable Indoor Air Quality in Low-Rise Residential Buildings. Table 1 contains the ventilation requirements for the 2010 version of the standard:

**Table 1 – ASHRAE 62.2-2010**

Floor Area (ft <sup>2</sup> )	Number of Bedrooms				
	0-1	2-3	4-5	6-7	>7
	CFM	CFM	CFM	CFM	CFM
<1500	30	45	60	75	90
1501 - 3000	45	60	75	90	105
3001 - 4500	60	75	90	105	120
4501 - 6000	75	90	105	120	135
6001 - 7500	90	105	120	135	150
>7500	105	120	135	150	165



**Table 2 – Maximum ERV Airflow Delivery (CFM) & Power Consumption<sup>1</sup>**

HVAC Return Pressure	ERV Fan Speed (CFM)								
	Low			Medium			High		
	Supply	Exhaust	Watts	Supply	Exhaust	Watts	Supply	Exhaust	Watts
-0.1" w.c.	74	69	67	104	122	103	121	148	135
-0.2" w.c.	93	62	66	120	116	102	136	143	135
-0.3" w.c.	110	54	66	135	110	102	150	137	135
-0.4" w.c.				150	103	102	163	132	135

<sup>1</sup>Maximum airflow delivery assumes no more than 0.1" external static from the duct collar to the intake or exhaust hood. If your duct runs are long or have a lot of bends or compressions, you may not be able to achieve the maximum airflow.

**2. Determine HVAC Return Pressure:**

The ERV is designed to provide a continuous supply of fresh outdoor air and is wired to turn on whenever the HVAC system blower turns on (i.e. is wired to the EAC terminals of the furnace). During continuous HVAC fan operation, the fan motor should be wired for low speed, so balance the system at low speed HVAC fan operation. (Refer to the furnace or fan coil literature for HVAC fan motor speed settings.) During heating or cooling, the return side pressure will cause the ERV to slightly positively pressurize the house.

Turn on the furnace blower by setting the thermostat to Fan On.

If the ERV is mounted to the return duct, measure the static pressure in the duct upstream of the ERV connection. If the ERV is mounted to the furnace, measure the pressure near the ERV outlets in the furnace cabinet. Use tubing to connect the pressure tap to the "LOW" or "- " connection of the pressure gauge.

Magnehelic pressure gauges are commonly used to measure static pressure as are digital pressure gauges. If using a Magnehelic dial gauge, choose one with a 0.0-in. w.c. to 0.5-in. w.c. range for the most precise measurement. A dial gauge must be mounted level to be properly zeroed.

**3. Set ERV Fan Speed:**

Use Table 2 to determine which ERV Fan Speed setting will be needed to deliver the required ventilation. Interpolate between listed values if the return pressure is not specifically listed.

Remove the electrical enclosure cover of the ERV and move the fan speed connector to the desired speed. Replace the electrical enclosure cover. (See Fig. 16.)

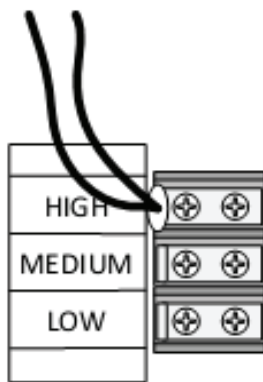
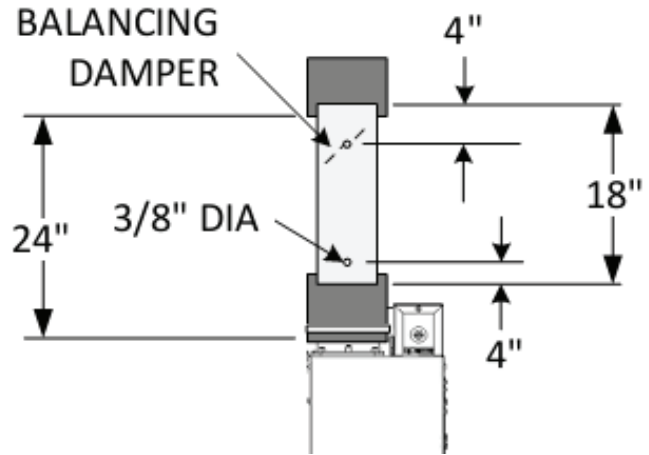

**Fig. 16 – Wiring for Different Speeds**

**NOTE:** Select a fan speed that results in airflow balance within ±10% or as required by the installation. Use the following balancing procedure in Step 4, as required to establish airflow balance.

**4. Balance the Supply and Exhaust Airflows:**

Cut the insulated flex duct approximately 24-in. from the ERV duct collars. Install an 18-in. section of 6-in. diameter sheet metal duct into both duct runs to be used for pressure measurements and installing a balancing damper.



**Fig. 17 – Damper Balancing Dimensions**

Before installing the sheet metal duct, drill a 3/8-in. diameter hole four inches (4-in.) from the bottom (end closest to the duct collar) and install the balancing damper four inches (4-in.) down from the top. Only install the flex duct to the sheet metal – do not pull the insulation over the sheet metal until after completing balancing.

Use static pressure to measure the airflow through the supply and exhaust ducts. Turn the HVAC system blower on to continuous fan speed (low speed) and plug in the ERV.

Measure the static pressure at the supply and exhaust duct and adjust the balancing dampers to achieve balanced airflow.

With both balancing dampers fully open, install the static pressure measuring probe into the 3/8-in. hole of the sheet metal duct and measure the static pressure of each duct. Connect the pressure tap to the "Low" or "- (neg.)" side of the pressure measuring instrument for measuring the supply duct and to the "High" or "+ (pos.)" side of the pressure measuring instrument for the exhaust duct.

Use the table on Page 7 that corresponds to the return side HVAC system pressure to determine the airflow in each duct. The duct with the lower airflow is the maximum balanced airflow; if this airflow is insufficient, change ERV blower speeds.

Use the balancing damper in the higher flow duct to balance with the lower flow duct. Lock the balancing damper into position. Pull one end of the flex duct over the sheet metal duct and tape to the sheet metal. Pull the other end of the flex duct over the sheet metal and tape the two flex duct sections together. Pull the insulation over the sheet metal duct and seal with tape.

**Apply the Brand Badge**

Select the appropriate brand logo badge. Remove the backing covering the adhesive. If the ERV is mounted vertically, attach the badge 2-in. above the top of the door, centered left-to-right on the ERV. If the ERV is mounted horizontally and the door is on the right, place the badge horizontally with its right edge 2-in. from the door, centered top-to-bottom on the unit. If the ERV is mounted horizontally and the door is on the left, place the badge horizontally with its left edge 2-in. from the door, centered top-to-bottom on the unit.

## NOTE TO ENERGY RATERS

HVI rated performance of this ERV is not representative of the actual CFM/watt performance in the actual application due to test protocol of the laboratory rating test. Actual ERV CFM/watt performance with the triangular openings connected to a location under negative static pressure will significantly improve. For example at medium speed with the connection location at -0.2-in. w.c. and with +0.1-in. w.c. duct connection static, a typical measurement is 1.14 CFM/watt. For additional performance data points more representative of actual application, refer to Table 2.

**Table 3 – ERV Airflow at -0.1” w.c. HVAC Return Pressure**

External Duct Pressure (“ w.c.)	ERV Fan Speed Setting (CFM)					
	Low		Medium		High	
	Sup-ply	Exh.	Sup-ply	Exh.	Sup-ply	Exh.
0.1	74	69	104	122	121	148
0.2	60	58	99	110	116	139
0.3	58	51	94	101	112	128
0.4			87	92	107	120
0.5			69	72		111

**Table 4 – ERV Airflow at -0.2” w.c. HVAC Return Pressure**

External Duct Pressure (“ w.c.)	ERV Fan Speed Setting (CFM)					
	Low		Medium		High	
	Sup-ply	Exh.	Sup-ply	Exh.	Sup-ply	Exh.
0.1	93	62	120	116	136	143
0.2	86	51	115	104	133	132
0.3	71		110	94	127	122
0.4	60		101	86	123	112
0.5			96	76	119	
0.6			89	67	115	
0.7			83		111	
0.8			76			
0.9			70			
1.0			64			

**Table 5 – ERV Airflow at -0.3” w.c. HVAC Return Pressure**

External Duct Pressure (“ w.c.)	ERV Fan Speed Setting (CFM)					
	Low		Medium		High	
	Sup-ply	Exh.	Sup-ply	Exh.	Sup-ply	Exh.
0.1	110	54	135	110	150	137
0.2	104		130	98	147	127
0.3	91		126	88	142	116
0.4	81		113	81	133	
0.5	71		109	70	128	
0.6	61		104	60	121	
0.7	51		85	50	116	
0.8			86			
0.9			81			
1.0			73			
1.1			66			
1.2			59			
1.3			52			

**Table 6 – ERV Airflow at -0.4” w.c. HVAC Return Pressure**

External Duct Pressure (“ w.c.)	ERV Fan Speed Setting (CFM)					
	Low		Medium		High	
	Sup-ply	Exh.	Sup-ply	Exh.	Sup-ply	Exh.
0.1			150	103	163	132
0.2			146	92	160	122
0.3			141	82	156	111
0.4			127	74	143	101
0.5			123	64	140	
0.6			114	55	133	
0.7			108		128	
0.8			102		124	
0.9			93		116	
1.0			86		110	
1.1			79			
1.2			71			
1.3			64			
1.4			57			

## MAINTENANCE AND TROUBLESHOOTING

### MAINTENANCE SCHEDULE

Every 3 months	<ul style="list-style-type: none"> <li>• Clean filters (rinse with water and shake out excess moisture before reinstalling in ERV)</li> </ul>
Every 6 months	<ul style="list-style-type: none"> <li>• Vacuum all faces of core using soft brush attachment. DO NOT RINSE WITH WATER – rinsing with water will damage core</li> <li>• Clean debris from intake/exhaust hoods</li> <li>• Inspect blowers (particularly the supply blower) and clean as needed</li> </ul>
As needed	<ul style="list-style-type: none"> <li>• Inspect ductwork to ensure the vapor barrier is intact to prevent condensation inside insulation</li> </ul>

### TROUBLESHOOTING

Problem	Possible Cause	Solution(s)
ERV is on but HVAC fan is not	ERV is wired to continuously live voltage	Wire to EAC terminals of furnace control board or, if installing with a fan coil, use Fan Coil Accessory Installation Kit , Part No. 5428
Neither ERV blower is on when HVAC fan is on	Loose electrical connection	<ol style="list-style-type: none"> <li>1. Check all quick-connect terminals in ERV control box to ensure all are engaged</li> <li>2. Push power cord fully into receptacle</li> </ol>
	No voltage from furnace EAC terminals or fan coil	Check wiring to furnace control board/fan coil and check furnace control board – consult with HVAC equipment manufacturer
	Door switch is not engaging or is faulty.	<ol style="list-style-type: none"> <li>1. Measure AC voltage between the “High” terminal of the 3-pole terminal block, and any terminal on the neutral (all white wires), 2-pole terminal block – if not 120 VAC, something in the door switch circuit needs repair</li> <li>2. Ensure quick connect terminals at the back of the switch are engaged.</li> <li>3. Manually press in the door switch. If ERV blowers still do not run, replace door switch with Part No. 5418.</li> <li>4. If blowers run, replace door and ensure it is properly aligned and that the hooks on the bottom of the door engage with the housing.</li> </ol>
	Transformer not providing voltage	<ol style="list-style-type: none"> <li>1. Ensure all quick connect terminals securely fastened to the 3-pole terminal block.</li> <li>2. Measure voltage between the selected fan speed terminal and any terminal on the neutral terminal block: Low – 70 VAC, Medium – 95 VAC. Replace transformer if voltage is not as shown.</li> </ol>
Just on ERV blower is not running	Loose electrical connection	Check all quick-connect terminals in ERV control box to ensure all are engaged
	Faulty capacitor	Disconnect wires from capacitor and measure capacitance – should be 6 $\mu$ F $\pm$ 5%. If outside of this range, replace capacitor with Part No. 5440.
	Blower disconnected	Remove brown wires from capacitor. Check for continuity between brown wire and any terminal on the neutral, 2-pole terminal block. If no continuity then the motor has become disconnected – reconnect motor.
	Blower wheel binding	Check the housing for damage and look inside the duct collar to verify that the motor wheel is not contacting the insulation.
Low airflow	Airflow restriction	<ol style="list-style-type: none"> <li>1. Clean the ERV filters</li> <li>2. Vacuum the ERV core</li> <li>3. Clean debris from intake/exhaust hoods</li> </ol>



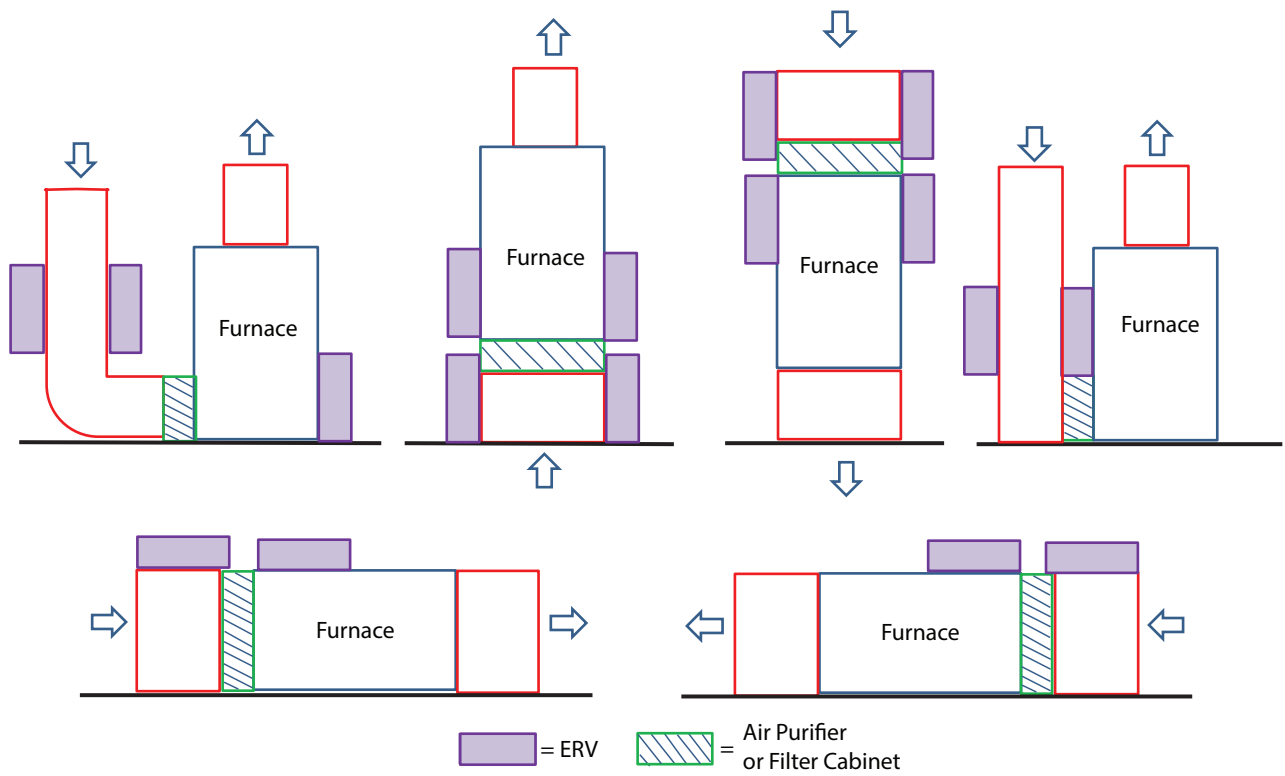

**Fig. 18 - ERV Installation Location Options for Furnace Applications**

A13291

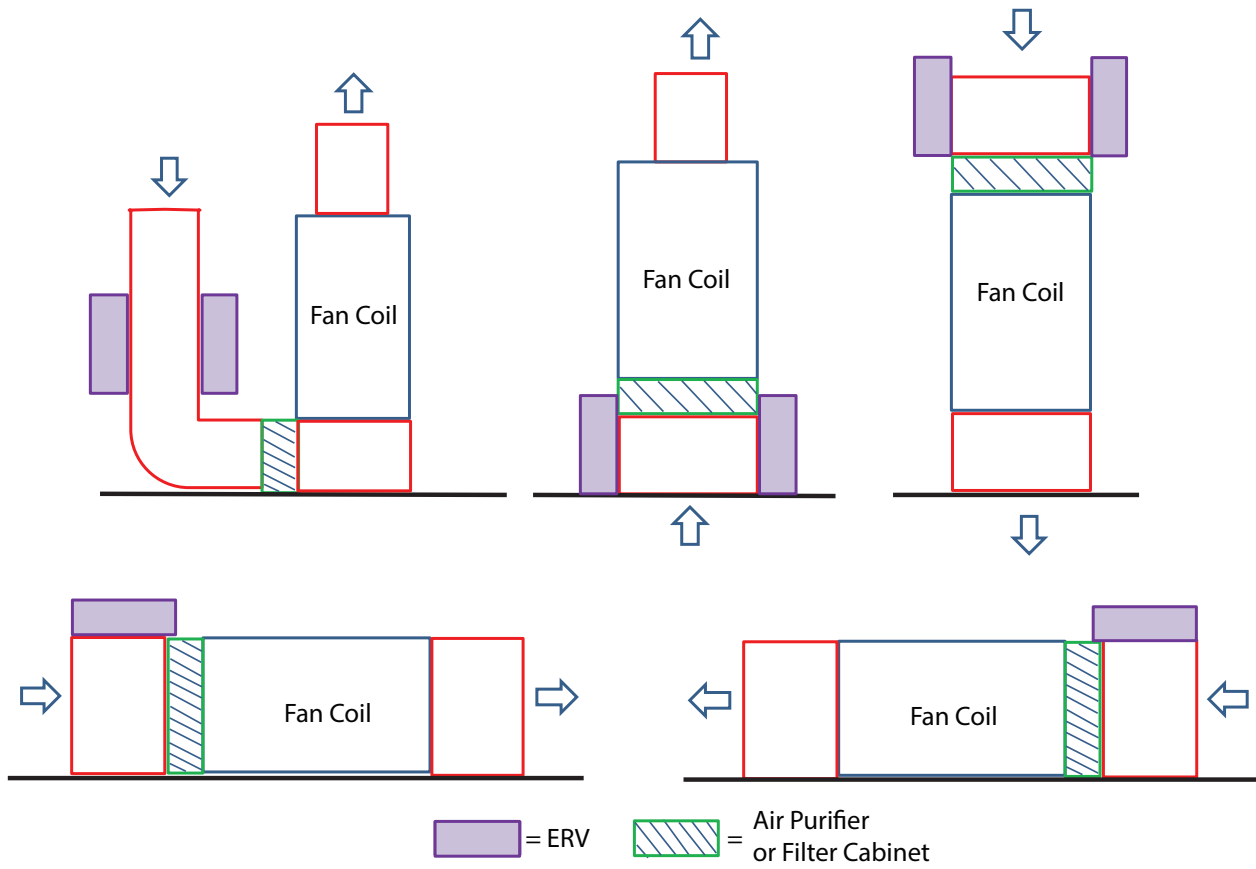

**Fig. 19 - ERV Installation Location Options for Fan Coil Applications**

A13291

