



brisa 

The word "brisa" is written in a large, black, lowercase, sans-serif font. A small blue dot is positioned above the letter 'i'. To the right of the word is a graphic consisting of three horizontal, wavy blue lines that resemble a stylized flame or a breeze.

MBRS24HPJ10A
MBRS30HPJ10A
MBRS36HPJ10A

OWNER'S MANUAL

Split Air Conditioner
INVERTER

Thank you for choosing our product.

For proper operation, please read and keep this manual for future reference.

If you have lost the Owner's Manual, please contact the local agent or visit

www.borealintl.com or send an email to borealsales@borealintl.com for the electronic version.

In line with the company's policy of continual product improvement, the aesthetic and dimensional characteristics, technical data and accessories of this appliance may be changed without notice.

CONTENTS

GENERAL INFORMATION

GENERAL INFORMATION	Conformity And Range	1
	The Instructions Before Use	2
	Name of Parts	3
	Technical Data	4
	Outdoor Unit Working Temperature Range	4
INSTALLER	Electrical Connections	5
	Installing The Outdoor Unit	7
	Bleeding	7
	Maintenance	8
	Installation Dimension Diagram	8
	Check After Installation	9

The products in this manual may be different with the real one, according to different models, some models have display and some models without display, the position and shape of the display please refer to the real one.

This appliance is not intended for use by persons (including children) with reduced physical, sensory or mental capabilities, or lack of experience and knowledge, unless they have been given supervision or instruction concerning use of the appliance by a person responsible for their safety.

Children should be supervised to ensure that they do not play with the appliance.

Explanation of Symbols



Indicates a hazardous situation that, if not avoided, will result in death or serious injury.



Indicates a hazardous situation that, if not avoided, could result in death or serious injury.



Indicates a hazardous situation that, if not avoided, may result in minor or moderate injury.



Indicates important but not hazard-related information, used to indicate risk of property damage.



Indicates a hazard that would be assigned a signal word WARNING or CAUTION.

CONFORMITY AND RANGE

GENERAL INFORMATION

This appliance can be used by children aged from 8 years and above and persons with reduced physical, sensory or mental capabilities or lack of experience and knowledge if they have been given supervision or instruction concerning use of the appliance in a safe way and understand the hazards involved.

Children shall not play with the appliance.

Cleaning and user maintenance shall not be made by children without supervision.

 Please read this owner's manual carefully before operating the unit and keep it carefully for consultation. Instructions for installation and use of this product are provided by the manufacturer.

 Only use the air conditioner as instructed in this booklet. These instructions are not intended to cover every possible condition and situation. As with any electrical household appliance, common sense and caution are therefore always recommended for installation, operation and maintenance.

WARNING

★ When having a burning smell or smoke, please turn off the power supply and contact with the service center.

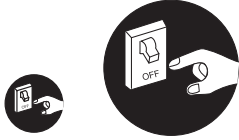

If the abnormality still exists, the unit may be damaged, and may cause electric shock or fire.

★ The power supply must adopt the special circuit that with air switch protection and assure it has enough capacity. The unit will be turned on or off according to your requirement automatically, please do not turn on or turn off the unit frequently, otherwise disadvantage effect may be caused to the unit.

★ Never cut off or damage power cables and control wires. If the power cable and signal control wire were damaged, change them by professional.



★ Power must adopt the special circuit to prevent fire.

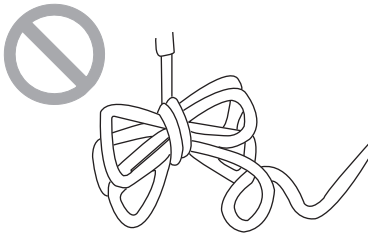

Otherwise, it can cause electric shock or fire.

★ Disconnect the power supply if long putting the air conditioner out of use.



Otherwise, the accumulated dusts may cause overheating or fire.

★ Never damage the electric wire or use the electric wire which is not appointed.



Otherwise, it will cause overheating or fire.

★ When cleaning, it is necessary to stop driving and turn off the power supply.

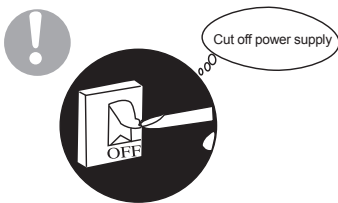

Otherwise, it may cause electric shock or damage.

★ Rated voltage of this air conditioner 208/230V, 60Hz, The compressor will vibrate sharply if the voltage is too low, resappointed. amage to refrigerating system. Electrical component are easy to damage if the voltage is too high.

★ Don't attempt to repair the air conditioner by yourself.

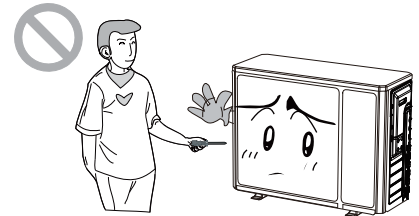

The wrong repair will lead to an electric shock or fire, so you should contact the service center to repair.

★ Please note whether the installed stand is firm enough or not.

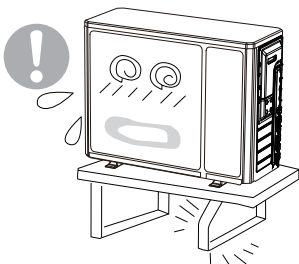

If it is damaged, it may lead to the fall of the unit and cause the injury.

★ Don't step on the top of the outdoor unit or place something on it.

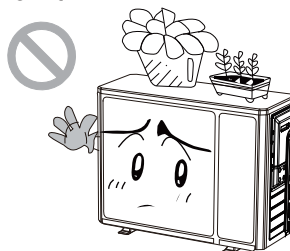

As falling off the outdoor unit can be dangerous.

★ Earthing: The unit must be reliably earthed. The earthing cable shall be connected to the special earthing device in the construction.



MBRS24HPJ10A 、 MBRS30HPJ10A

WARNING

- Be sure to cut off the power supply before cleaning the air conditioner; otherwise electric shock might happen.
- Wetting of air conditioner may cause the risk of electric shock. Make sure not to wash your air conditioner in any case.
- Volatile liquids such as thinner or gasoline will cause damage to the appearance of air conditioner. (Only use soft dry cloth moist cloth clean the air conditioner cabinet).
- This product must not be disposed together with the domestic waste. This product has to be disposed at an authorized place for recycling of electrical and electronic appliances.
- The temperature of refrigerant circuit will be high, please keep the interconnection cable away from the copper tube.



OUTDOOR UNIT	
No.	Description
1	Air outlet grille
2	Valve

Note: The above figures are only intended to a simple diagram of the appliance and may not correspond to the appearance of the units that have been purchased.

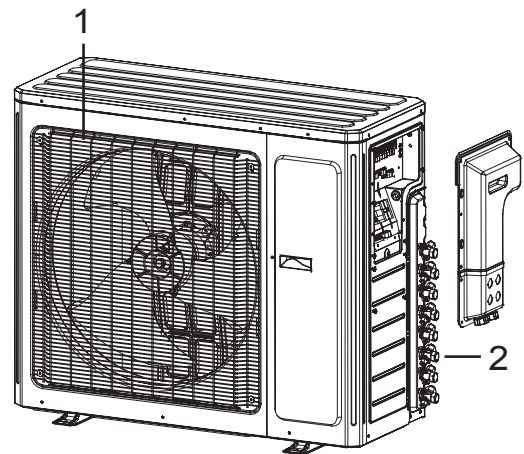

MBRS36HPJ10A 、

WARNING

- If the supply cord is damaged, it must be replaced by the manufacturer or its service agent or a similarly qualified person in order to avoid a hazard.
- Be sure to cut off the power supply before cleaning the air conditioner; otherwise electric shock might happen.
- Wetting of air conditioner may cause the risk of electric shock. Make sure not to wash your air conditioner in any case.
- Volatile liquids such as thinner or gasoline will cause damage to the appearance of air conditioner. (Only use soft dry cloth moist cloth clean the air conditioner cabinet).
- Do not dispose this product as unsorted municipal waste. Collection of such waste separately for special treatment is necessary.
- The temperature of refrigerant circuit will be high, please keep the interconnection cable away from the copper tube.

OUTDOOR UNIT	
No.	Description
1	Air outlet grille
2	Valve

Note: The above figures are only intended to be a simple diagram of the appliance and may not correspond to the appearance of the units that have been purchased.

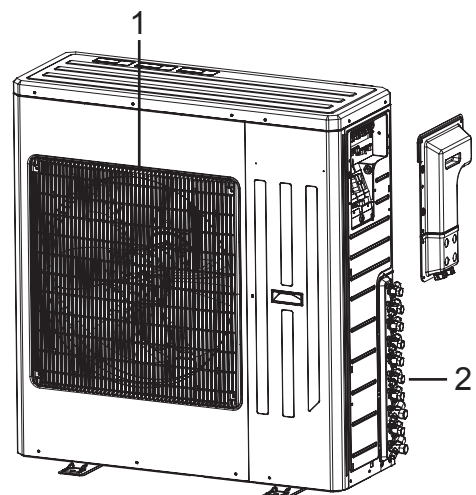

TECHNICAL DATA

GENERAL INFORMATION

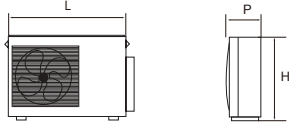
MODEL	MBRS24HPJ10A		
Electrical data			
Electricity supply	208/230V,60Hz		
Fuse or air switch	30		A
Minimum power cord section	3.3		mm ²
Size and clearance			
	L	920	mm
	P	380	mm
	H	790	mm

TECHNICAL DATA

GENERAL INFORMATION

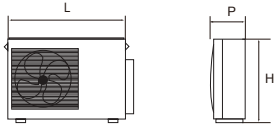
MODEL	MBRS30HPJ10A		
Electrical data			
Electricity supply	208/230V,60Hz		
Fuse or air switch	30		A
Minimum power cord section	3.3		mm ²
Size and clearance			
	L	920	mm
	P	370	mm
	H	787	mm

TECHNICAL DATA

GENERAL INFORMATION

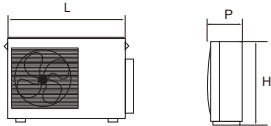
MODEL	MBRS36HPJ10A		
Electrical data			
Electricity supply	208/230V,60Hz		
Fuse or air switch	35		A
Minimum power cord section	3.3		mm ²
Size and clearance			
	L	1016	mm
	P	362	mm
	H	1103	mm

OUTDOOR UNIT WORKING TEMPERATURE RANGE

GENERAL INFORMATION

	Outdoor side DB/WB(°F/°C)
Maximum cooling	118.4(48)/-
Maximum heating	80.6(27)/-

**MBRS24HPJ10A MBRS30HPJ10A
MBRS36HPJ10A**

1. Remove the handle at the right side plate of the outdoor unit (one screw).
2. Remove the cable clamp, connect the power connection cable with the terminal at the row of connection and fix the connection. The fitting line distributing must be consistent with the indoor unit. Wiring should meet that of indoor unit.
3. Fix power connection wire by wire clamp.
4. Ensure wire has been fixed well.
5. Install the handle.

! An all-pole disconnection switch having a contact separation of at least 3mm in all pole should be connected in fixed wiring.

! Wrong wire connection may cause malfunction of some electric components. After fixing cable, ensure that leads between connection to fixed point have some space.

! The connection pipes and the connecting wirings of the unit A and unit B must be corresponding to each other respective.

! The appliance shall be installed in accordance with national wiring regulations.

Note: the above figures are only intended to be a simple diagram of the appliance and may not correspond to the appearance of the units that have been purchased.

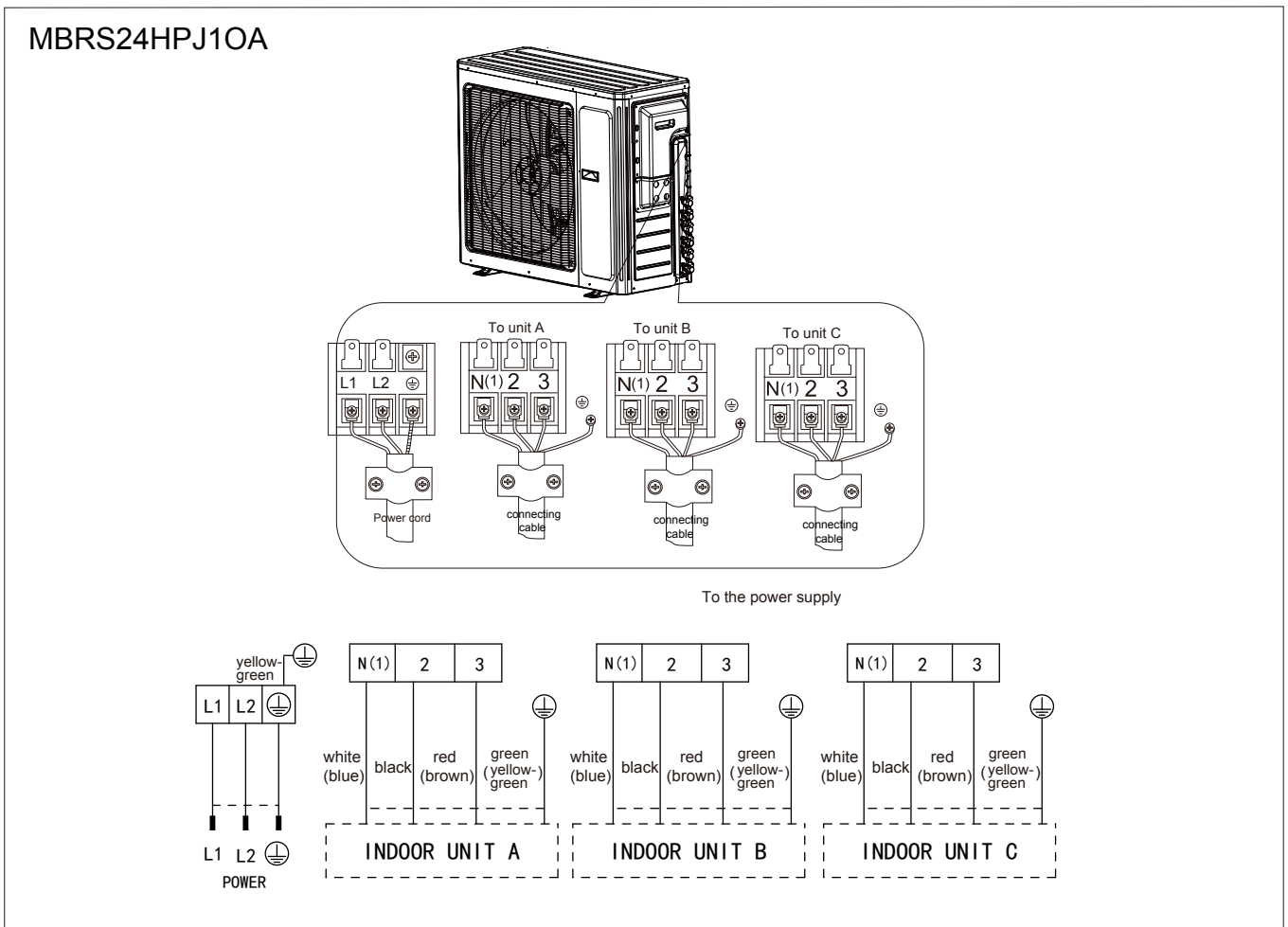

MBRS30HPJ10A

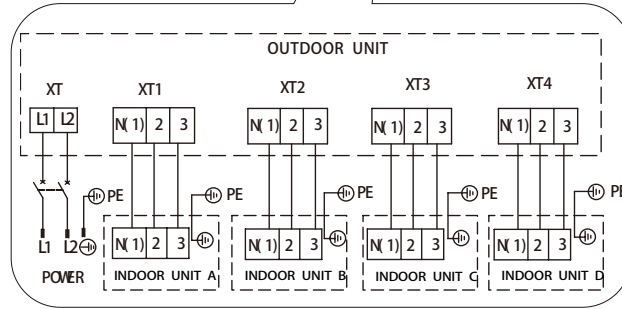
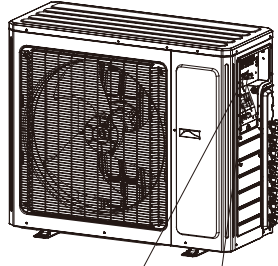

MBRS36HPJ10A

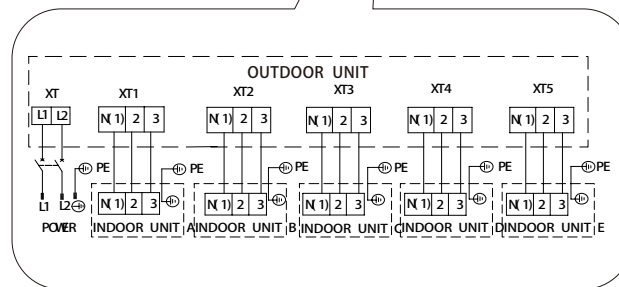
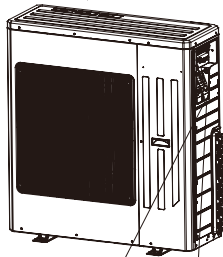

Location

- ⚠ Use bolts to secure the unit to a flat, solid floor. When mounting the unit on a wall or the roof, make sure the support is firmly secured so that it cannot move in the event of intense vibrations or a strong wind.
- Do not install the outdoor unit in pits or air vents

Installing the pipes

- ⚠ Use suitable connecting pipes and equipment for the refrigerant R410A.

Models(m)	18Kx2	24Kx2	24Kx3	28Kx4
Max. connection pipe length	20	20	60	70
Max. connection pipe length (Simple one indoor unit)	10	10	20	20

Models(m)	30Kx4	36Kx5	42Kx5
Max. connection pipe length	70	75	75
Max. connection pipe length (Simple one indoor unit)	25	25	25

- ⚠ The refrigerant pipes must not exceed the maximum heights 10m(18Kx2&24Kx2&24Kx3&28Kx4&30Kx4 &36Kx5&42Kx5).
- ⚠ Wrap all the refrigerant pipes and joints.
- ⚠ Tighten the connections using two wrenches working in opposite directions.

BLEEDING

Humid air left inside the refrigerant circuit can cause compressor malfunction. After having connected the indoor and outdoor units, bleed the air and humidity from the refrigerant circuit using a vacuum pump.

- (1) Unscrew and remove the caps from the 2-way and 3-way valves.
- (2) Unscrew and remove the cap from the service valve.
- (3) Connect the vacuum pump hose to the service valve.
- (4) Operate the vacuum pump for 10-15 minutes until an absolute vacuum of 10 mm Hg has been reached.
- (5) With the vacuum pump still in operation, close the low-pressure knob on the vacuum pump coupling. Stop the vacuum pump.
- (6) Open the 2-way valve by 1/4 turn and then close it after 10 seconds. Check all the joints for leaks using liquid soap or an electronic leak device.
- (7) Turn the body of the 2-way and 3-way valves. Disconnect the vacuum pump hose.
- (8) Replace and tighten all the caps on the valves.

Diameter (mm)	Twisting moment (N.m)
Φ6	15-20
Φ9.52	35-40
Φ16	60-65
Φ12	45-50
Φ19	70-75

30、36、42Kunit need to be installed the indoor unit

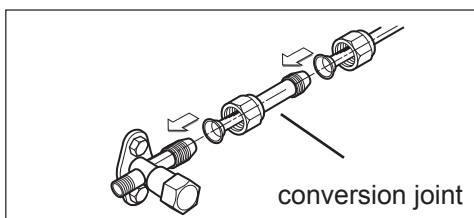

Caution: Installation Must be Performed in Accordance with the NEC/CEC by Authorized Personnel Only.

Install the drain fitting and the drain hose (for model with heat pump only)

Condensation is produced and flows from the outdoor unit when the appliance is operating in the heating mode. In order not to disturb neighbours and to respect the environment, install a drain fitting and a drain hose to channel the condensate water. Install the drain fitting and rubber washer on the outdoor unit chassis and connect a drain hose to it as shown in the figure.

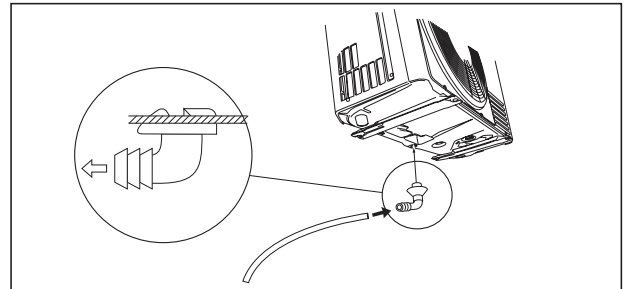

INSTALLER

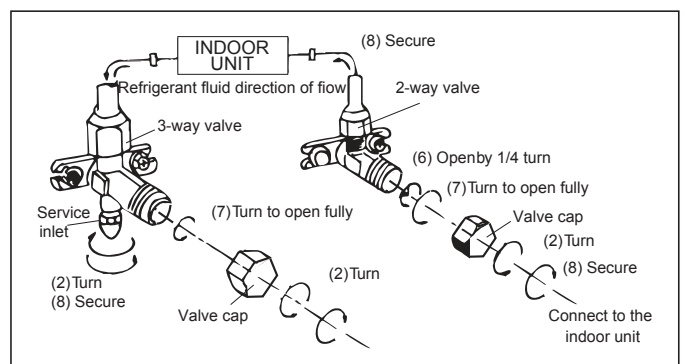
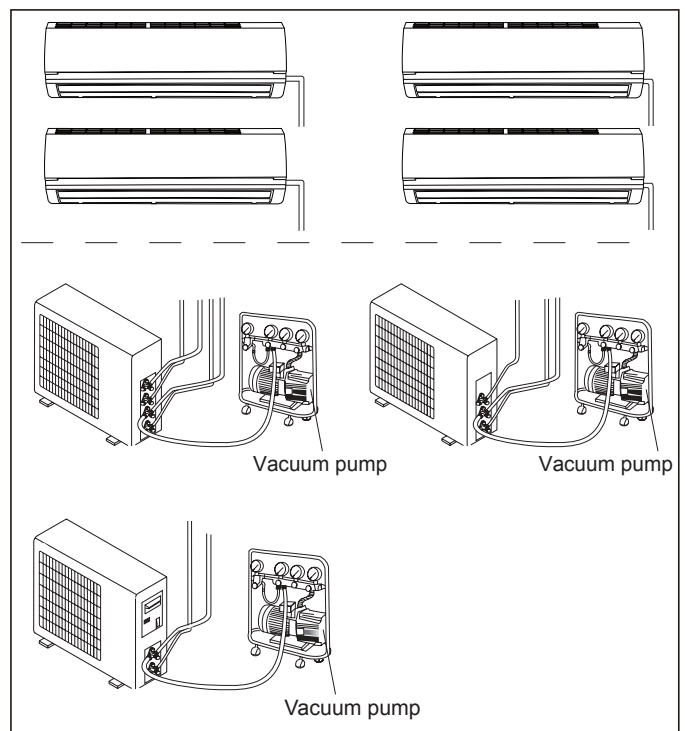

- ⚠ Use suitable instruments for the refrigerant R410A.
- Do not use any other refrigerant than R410A.
- ⚠ Do not use mineral oils to clean the unit.

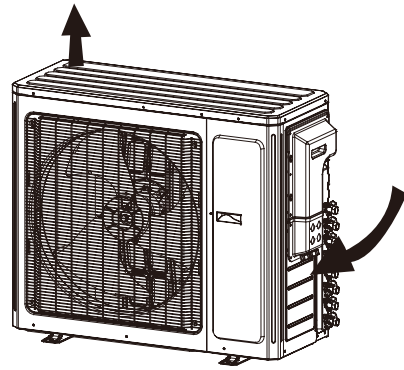

INSTALLATION DIMENSION DIAGRAM

- ⚠ The installation must be done by trained and qualified service personnel with reliability according to this manual.
- ⚠ Contact service center before installation to avoid the malfunction due to unprofessional installation.
- ⚠ When picking up and moving the units, you must be guided by trained and qualified person.
- ⚠ Ensure that the recommended space is left around the appliance.

MBRS24HPJ10A
MBRS30HPJ10A

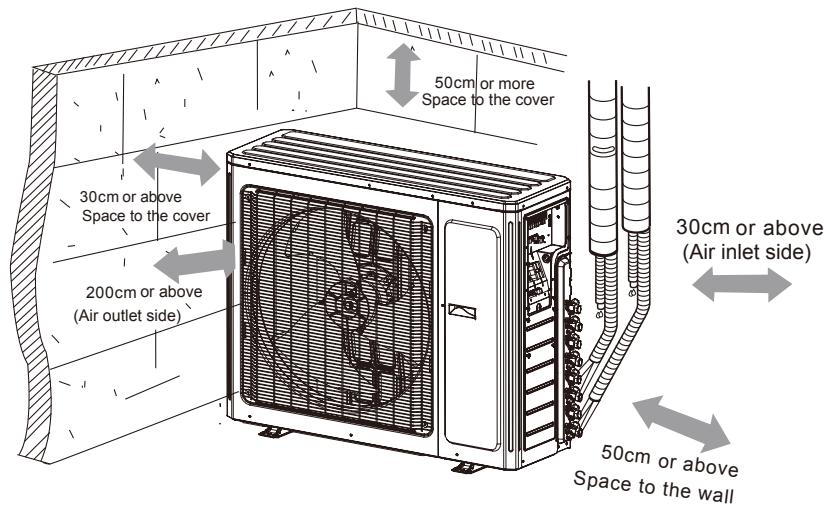

MBRS36HPJ10A

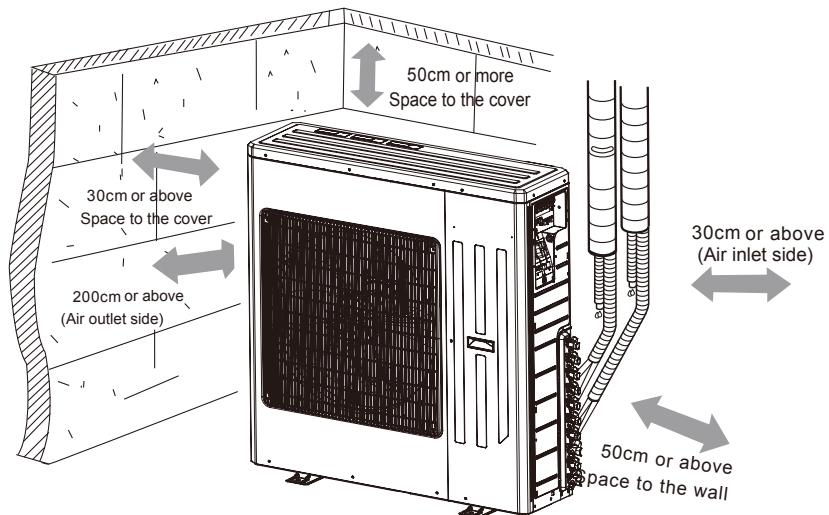

Check Items	Problems Owing to Improper Installation
Is the installation reliable?	The unit may drop, vibrate or make noises
Has the gas leakage been checked?	May cause unsatisfactory cooling (heating) effect
Is the thermal insulation of the unit sufficient?	May cause condensation and water dropping
Is the drainage smooth?	May cause condensation and water dropping
Does the power supply voltage accord with the rated voltage specified on the nameplate?	The unit may bread down or the components may be burned out
Are the lines and pipelines correctly installed?	The unit may bread down or the components may be burned out
Has the unit been safely grounded?	Risk of electrical leakage
Are the models of lines in conformity with requirements?	The unit may bread down or the components may be burned out
Are there any obstacles near the air inlet and outlet of the indoor and outdoor units?	The unit may bread down or the components may be burned out
Have the length of refrigerating pipe and refrigerant charge amount been recorded?	It is not easy to decide the charge amount of refrigerant.

Boreal International a Watsco Inc. subsidiary

borealsales@borealintl.com, www.borealintl.com,

10300 NW 19th St. #105, Doral, FL 33172, 786-621-8250



66129935470