

| | | | |
|-----|----------------|-----|----------------|
| 24" | HG24NE470AFXZA | 43" | HG43NE470SFXZA |
| 28" | HG28NE470AFXZA | 49" | HG49NE470HFXZA |
| 32" | HG32NE470FFXZA | 55" | HG55NE470BFXZA |
| 40" | HG40NE470SFXZA | | |

Upgrade affordably to a superior LED experience.

NE470 Series Hospitality TVs

Meet guests' TV expectations with the LED industry leader.

The leading LED panel manufacturer in the world allows you to deliver a superior experience to your guests, while still being budget-conscious. Introducing the Samsung 470 Series Hospitality TVs. With direct-lit LED technology, the 470 Series delivers all the benefits of LED, while doing it more affordably. You'll be able to deliver the bright, beautiful pictures that guests are used to from their own TVs at home, while your cost of entry is similar to that of a traditional CCFL back-lit option. LED uses up to 50% less energy, too, helping you conserve and save money. Content management is made simple with the Samsung REACH 4.0 management solution. And Samsung's LYNK™ DRM technology protects content, while offering guests a seamless viewing experience. It's the platform that delivers an at-home, in-room experience, affordably. From Samsung.



Key Features



Direct-Lit LED technology for an affordable, superior experience.

Direct-lit LED technology provides the brilliance and energy savings advantages of LED technology, along with the uniform brightness typical of CCFL displays. And it does it all with an efficiency that makes it a more affordable technology. In fact, it's possible to upgrade your rooms to LED technology for a cost comparable to CCFL technology.



Samsung LYNK™ DRM HD content decryption.

Samsung's software-based DRM technology is integrated into the entire Samsung Hotel TV line. Samsung LYNK™ offers a robust solution to unlock premium HDTV content from content providers such as cable, satellite and VOD providers, with maximum efficiency and security.



Samsung LYNK™ REACH 4.0 content management solution.

Samsung's LYNK REACH 4.0 is a complete content management solution that accommodates coaxial, LAN and Wi-Fi infrastructures to amplify hotel management, monitoring and guest service functions. LYNK REACH 4.0 enriches the guest experience with efficiency-enhancing technology that transforms the in-room display into a comprehensive digital experience.



A host of features.

The display pedestal stands rotate with 20/20, 60/60 and 90/90 degree stops, for easy adjustability (excludes 24" and 28" models). Other features of the 470 Series include: Home Menu, RJ12 IR PASS, Volume Limiters, Rear Panel Lock-out, Menu Display Lock-out, Hotel Custom Logo/Welcome Message, Channel List Guide, Channel Re-mapping, Remote Jack Pack (RJP) Priority, USB Cloning and Anti-Theft Battery Cover Remote Control.

A better environment and easier management through Samsung LYNK.™

Samsung LYNK REACH 4.0 CMS delivers more than just content.

Control content on hundreds of TVs at once. Eliminate room-by-room visits to each guest room by using a single-location remote solution. The REACH (RF) Server delivers updated firmware and other settings to TVs through RF signals. REACH (IP) is also available for centralized control of SMART hospitality TVs without the need of additional hardware. Updates are simple and simultaneous, so there's no need to go from room to room to update each display with USB Cloning. This way, your staff has more time to focus on other ways of improving the guest experience.

Reinforce your brand. Extend your hospitality beyond your front lobby and into your rooms for a tailored, personalized guest experience. With the fully customizable Graphical User Interface (GUI), you can choose from the pre-built templates or upload your own assets to develop a GUI from scratch. Plus, Samsung has a network of certified REACH integration partners who can also provide turnkey solutions.

Keep your guests entertained. LYNK REACH provides channel management capabilities including a customizable interactive program guide. Additionally, with third-party casting services, your guests can connect their mobile devices to the in-room screen. With a few easy steps, they can access 1000+ apps for an exceptional entertainment experience.

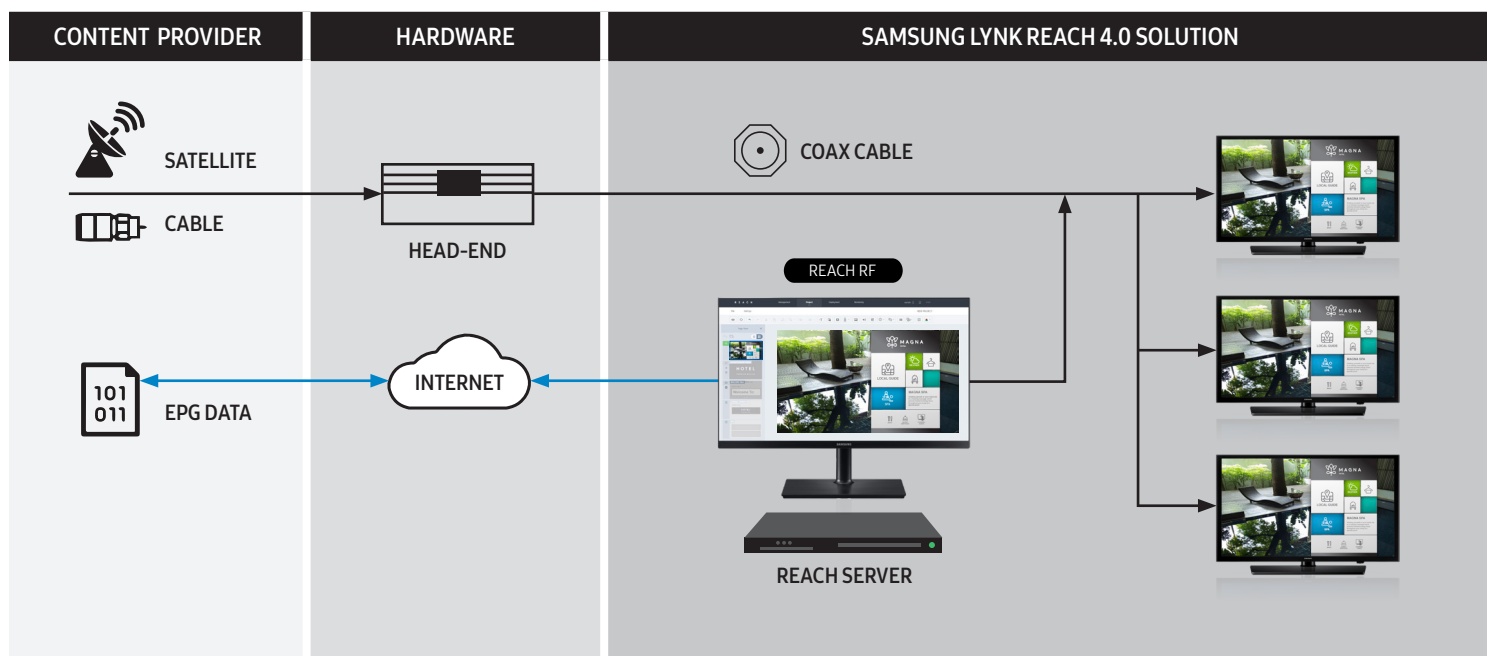

Digital Rights Management (DRM)

Samsung LYNK™ DRM HD Content Decryption (RF)

Samsung's software-based DRM technology is integrated into the entire Samsung Hotel TV line. Samsung LYNK™ offers a robust solution to unlock premium HDTV content from content providers such as cable, satellite and VOD providers, with maximum efficiency and security.



Connections

AnyNet+ (HDMI – CEC)

This Samsung protocol allows the user to control other HDMI devices connected to the TV display, such as DVD players, PC computers and Soundbars.

ConnectShare™ (USB 2.0)

Connect a thumb drive or digital camera quickly and easily. User-friendly interface allows access to videos, a music playlist and pictures via the remote.

Hotel TV (RJ-12/IR Pass Through)

Allows you to connect an interactive STB/SBB (Set Top Box/Set Back Box).

Interactive Compatibility System



Remote Jack Panel (RJP) Compatibility



Management and Guest Convenience

Anti-Theft Battery Cover

Battery door is secured, ensuring batteries remain in the remote controller.

Auto Channel Search

Auto detect channel while in Hotel mode.

Clock On Timer and Alarm Key

Allows guests to program their TVs to turn on as a wake-up alarm.

Closed Captioning

A text display of all audio content, including spoken dialog and non-speech information such as the identity of the speakers and symbols for sound effects and music.

Hotel Channel List

Guest master channel listing of program content. This will display content in analog or HD.

Hotel Logo Display with Time Out Setting

Display hotel logo bitmap files as a greeting startup display.

Hotel Mode Plug & Play

Interactive and Stand-Alone modes available.

Multi-Code Remote

Eliminates interference when two or more TVs are used in close proximity to each other.

Lockout Controls

The hotelier can enable front panel and menu display lock-outs.

Picture-in-Picture

Display one program while another is being displayed on the full TV screen at the same time.

Power On Status Setting

Settings include Power Always On, Last Option or Standby.

On Screen Display Language

Choose English/French/Spanish.

Sleep Timer

Allows guests to set TV turn-off time in 30-minute intervals up to 180 minutes.

USB Cloning

A quick and easy way to copy the ideal settings off one television to others on the property. Saves time and helps provide a consistent viewing experience for all televisions.

Picture and Audio

Auto Volume Limiter

During initial product setup, minimum and maximum volume levels can be locked to help minimize disturbance to other hotel guests.

Music Mode (Input: HDMI/PC/AV/Component)

Allows audio feedback when picture is muted.

Music Mode Backlight On/Off

Background display.

Premium Slim Direct-Lit LED Technology

Direct-lit LED technology provides the brilliance and energy savings advantages of LED technology, along with the uniform brightness typical of CCFL displays. And it does it all with an efficiency that makes it a more affordable technology. In fact, it's possible to upgrade your rooms to LED technology for a cost comparable to CCFL technology. When you add the energy savings of up to 50% that LED offers over CCFL, you end up with the perfect solution for both you and your guests.

Samsung Soundbar Compatible

Samsung Hospitality Displays enable Soundbar compatibility by supporting HDMI-CEC. When you connect the Soundbar to the Samsung Hospitality Display with an HDMI cable, the TV audio settings and menu lock feature are automatically applied, so you don't have to set up the Soundbar separately. You can also prevent guests from changing the settings. With a single remote, guests can control both the TV and Soundbar simultaneously.

Swivel (20/20, 60/60, 90/90) Stands

Pedestal stands rotate with 20/20, 60/60 and 90/90 degree stops, so wherever in the room your guests are, they should have an excellent view of their TV (not available on 24" and 28"). Swivel stand includes integrated mounting plate and bolt-down kit.

HD and FHD Resolution

The 24" and 28" NE470 Series TVs feature 1366 x 768 HD resolution, the 32" features 1360 x 768, and 40", 43", 50" and 55" models feature 1920 x 1080 FHD resolution. All deliver the sharp, clear, colorful images Samsung is known for.

Warranty

Hospitality Warranty

2-year parts and 2-year labor warranty backed by the Samsung Hospitality Hotline at 1-866-894-0524. Optional professional installation, accessories and extended warranty are available.

NE470 Series Dimensions

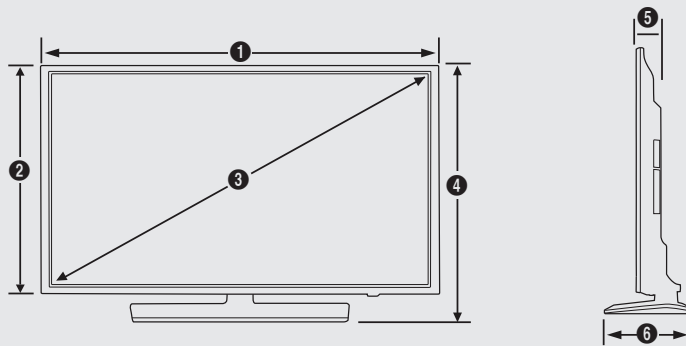

24" | HG24NE470AFXZA - 720p

| 1 | 2 | 3 | 4 | 5 | 6 |
|-------|-------|-------|-------|------|------|
| 22.1" | 13.7" | 24.0" | 15.1" | 2.6" | 6.4" |

28" | HG28NE470AFXZA - 720p

| 1 | 2 | 3 | 4 | 5 | 6 |
|-------|-------|-------|-------|------|------|
| 25.0" | 15.6" | 28.0" | 17.1" | 2.5" | 6.4" |

32" | HG32NE470FFXZA - 720p

| 1 | 2 | 3 | 4 | 5 | 6 |
|-------|-------|-------|-------|------|------|
| 29.3" | 17.4" | 32.0" | 19.1" | 2.7" | 7.6" |

40" | HG40NE470SFXZA - 1080p

| 1 | 2 | 3 | 4 | 5 | 6 |
|-------|-------|-------|-------|------|------|
| 36.3" | 20.9" | 40.0" | 22.9" | 2.8" | 8.9" |

43" | HG43NE470SFXZA - 1080p

| 1 | 2 | 3 | 4 | 5 | 6 |
|-------|-------|-------|-------|------|------|
| 38.8" | 22.6" | 43.0" | 24.6" | 2.8" | 8.9" |

49" | HG49NE470HFXZA - 1080p

| 1 | 2 | 3 | 4 | 5 | 6 |
|-------|-------|-------|-------|------|------|
| 44.0" | 25.6" | 49.0" | 27.6" | 2.9" | 8.9" |

55" | HG55NE470BFXZA - 1080p

| 1 | 2 | 3 | 4 | 5 | 6 |
|-------|-------|-------|-------|------|------|
| 48.5" | 27.9" | 55.0" | 30.1" | 2.7" | 8.9" |



NE470 Series Connectivity

HG24NE470AFXZA

- | | |
|-------------------------------|-----------------------------|
| 1. USB (5C 0.5A) / Cloning | 5. Data (RJ12) |
| 2. HDMI In 1 (DVI) | 6. Audio Out |
| 3. AV In (Video, Audio L / R) | 7. Ex-Link (RS-232C) |
| 4. HDMI In 2 (ARC) | 8. Antenna In (Air / Cable) |

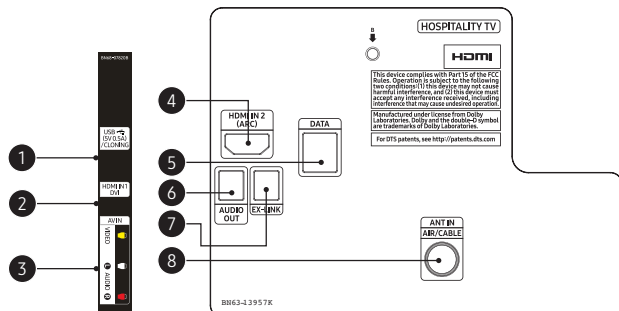

HG40NE470SFXZA / HG43NE470SFXZA

- | | |
|-------------------------------|-----------------------------|
| 1. USB (5C 0.5A) / Cloning | 5. Data (RJ12) |
| 2. HDMI In 1 (DVI) | 6. Audio Out |
| 3. AV In (Video, Audio L / R) | 7. Ex-Link (RS-232C) |
| 4. HDMI In 2 (ARC) | 8. Antenna In (Air / Cable) |

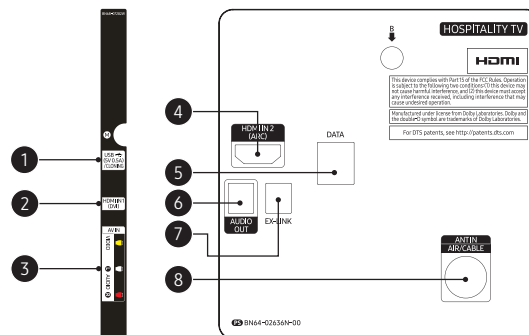

HG28NE470AFXZA

- | | |
|-------------------------------|-----------------------------|
| 1. USB (5C 0.5A) / Cloning | 5. Data (RJ12) |
| 2. HDMI In 1 (DVI) | 6. Audio Out |
| 3. AV In (Video, Audio L / R) | 7. Ex-Link (RS-232C) |
| 4. HDMI In 2 (ARC) | 8. Antenna In (Air / Cable) |

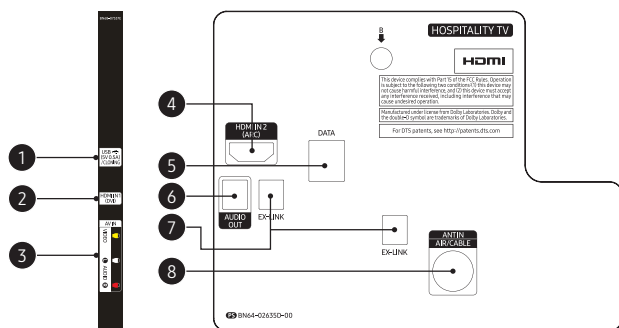

HG49NE470HFZA

- | | |
|-------------------------------|-----------------------------|
| 1. HDMI In 2 (DVI) | 5. Data (RJ12) |
| 2. USB (5C 0.5A) / Cloning | 6. Ex-Link (RS-232C) |
| 3. HDMI In 1 (ARC) | 7. Audio Out |
| 4. AV In (Video, Audio L / R) | 8. Antenna In (Air / Cable) |

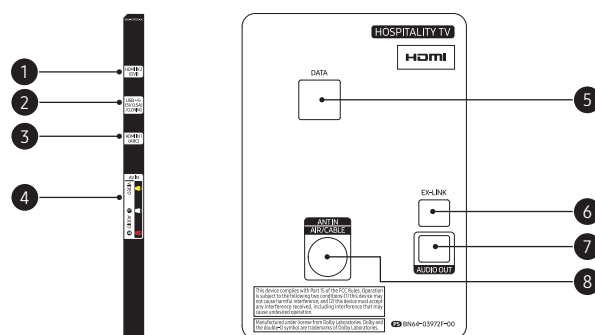

HG32NE470FFXZA

- | | |
|-------------------------------|-----------------------------|
| 1. HDMI In 2 (DVI) | 5. Data (RJ12) |
| 2. USB (5C 0.5A) / Cloning | 6. Ex-Link (RS-232C) |
| 3. HDMI In 1 (ARC) | 7. Audio Out |
| 4. AV In (Video, Audio L / R) | 8. Antenna In (Air / Cable) |

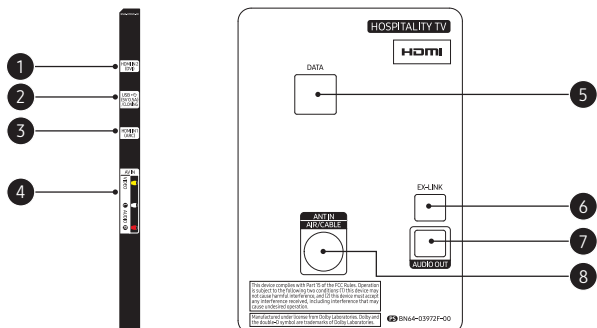

HG55NE470BFXZA

- | | |
|-------------------------------|-----------------------------|
| 1. USB (5C 0.5A) / Cloning | 5. Data (RJ12) |
| 2. HDMI In 1 (DVI) | 6. Audio Out |
| 3. AV In (Video, Audio L / R) | 7. Ex-Link (RS-232C) |
| 4. HDMI In 2 (ARC) | 8. Antenna In (Air / Cable) |

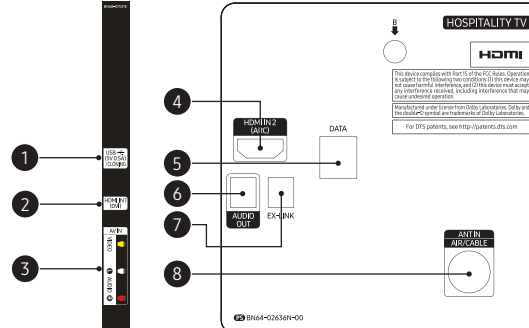

Samsung NE470 Series Hospitality TVs

NE470 Series Key Specifications For complete product specifications, visit samsung.com/hospitality

| | | HG24NE470AFXZA | HG28NE470AFXZA | HG32NE470FFXZA | HG40NE470SFXZA | |
|-----------------------------|---|--|--|--|---|------------------|
| Display | Backlight | LED | LED | LED | LED | |
| | Screen Size (Diagonal) | 24" | 28" | 32" | 40" | |
| | HD/FHD | HD | HD | HD | FHD | |
| | Resolution | 1366 x 768 | 1366 x 768 | 1360 x 768 | 1920 x 1080 | |
| Video | Picture Engine | HyperReal | HyperReal | HyperReal | HyperReal | |
| | Dynamic Contrast Ratio | Mega Contrast | Mega Contrast | Mega Contrast | Mega Contrast | |
| | Wide Color Enhancer (Plus) | Yes | Yes | Yes | Yes | |
| | Film Mode | Yes | Yes | Yes | Yes | |
| Audio | Dolby Digital Plus | Yes | Yes | Yes | Yes | |
| | DTS Codec | Yes | Yes | Yes | Yes | |
| | Sound Output (RMS) | 10W (L:5W, R:5W) | 10W (L:5W, R:5W) | 10W (L:5W, R:5W) | 20W (L:10W, R:10W) | |
| | Speaker Type | 2CH (Down Firing w/Base Reflex) | 2CH (Down Firing w/Base Reflex) | 2CH (Down Firing w/Base Reflex) | 2CH (Down Firing w/Base Reflex) | |
| | Wall Mount Sound Mode | Yes | Yes | No | Yes | |
| SMART TV Features | Smart TV Type | Non Smart | Non Smart | Non Smart | Non Smart | |
| | Accessibility | Voice Guide | Voice Guide | Voice Guide | Voice Guide | |
| | Digital Clean View | Yes | Yes | Yes | Yes | |
| | Auto Channel Search | Yes | Yes | Yes | Yes | |
| | Auto Power Off | Yes | Yes | Yes | Yes | |
| | Caption (Subtitle) | Yes | Yes | Yes | Yes | |
| | ConnectShare™ (USB 2.0) | Yes | Yes | Yes | Yes | |
| | EPG | Yes | Yes | Yes | Yes | |
| | Game Mode | Yes | Yes | Yes | Yes | |
| | OSD Language | English, Spanish, French | English, Spanish, French | English, Spanish, French | English, Spanish, French | |
| | Picture-In-Picture | Yes | Yes | Yes | Yes | |
| | System | Digital Broadcasting | ATSC / Clear QAM | ATSC / Clear QAM | ATSC / Clear QAM | ATSC / Clear QAM |
| | | Analog Tuner | Yes | Yes | Yes | Yes |
| Hospitality Features | Samsung LYNK™ REACH (RF) | REACH 4.0 | REACH 4.0 | REACH 4.0 | REACH 4.0 | |
| | Samsung LYNK™ REACH RF Modulator Compatibility | Yes | Yes | Yes | Yes | |
| | Hospitality Home Menu | Home Menu 2015 | Home Menu 2015 | Home Menu 2015 | Home Menu 2015 | |
| | Hospitality Plug&Play (Easy Setup) | Yes | Yes | Yes | Yes | |
| | Auto Source Mode | Yes | Yes | Yes | Yes | |
| | Power On Mode | Yes | Yes | Yes | Yes | |
| | Hotel Channel List | Yes | Yes | Yes | Yes | |
| | Channel Menu Display | Yes | Yes | Yes | Yes | |
| | Mixed Channel List (ATSC, DVB-T/T2/C/S2, Analog) | Yes | Yes | Yes | Yes | |
| | My Channel | Yes | Yes | Yes | Yes | |
| | Energy Saving Mode (BLU Control) | Yes | Yes | Yes | Yes | |
| | Logo Display with Timer Out Setting (BMP/Movie) | Yes | Yes | Yes | Yes | |
| | Welcome Message | Yes | Yes | Yes | Yes | |
| | RJ12 / IR Pass Through | Yes | Yes | Yes | Yes | |
| | Clock Back Up Power Supply | Yes | Yes | Yes | Yes | |
| | Software Clock | Yes | Yes | Yes | Yes | |
| | Multi Code Remote Control | Yes | Yes | Yes | Yes | |
| | Screwed Battery Cover | Yes | Yes | Yes | Yes | |
| | Sound Bar Compatibility | Yes | Yes | Yes | Yes | |
| | Music Mode (Input: PC/AV/Component/HDMI) | Yes | Yes | Yes | Yes | |
| Music Mode Backlight On/Off | Yes | Yes | Yes | Yes | | |
| Input and Output | HDMI (Side/Rear) | 1/1 | 1/1 | 2/0 | 1/1 | |
| | USB (Side/Rear) | 1/0 | 1/0 | 1/0 | 1/0 | |
| | Composite In (AV) (Side/Rear) | 1/0 | 1/0 | 1/0 | 1/0 | |
| | Audio Out (Mini Jack / LR) (Side/Rear) | 0/1 | 0/1 | 0/1 | 0/1 | |
| | RF In (Terrestrial / Cable input / Satellite Input) (Side/Rear) | 0/1 | 0/1 | 0/1 | 0/1 | |
| | Ex-Link (RS232C) | Common (RJP) | Common (RJP) | Common (RJP) | Common (RJP) | |
| | HDMI A / Return Ch. Support | Yes | Yes | Yes | Yes | |
| | Anynet+ (HDMI-CEC) | Yes | Yes | Yes | Yes | |
| | RJ12 (Side/Rear) | 0/1 | 0/1 | 0/1 | 0/1 | |
| | RJP Jack (For Remote Jackpack) (Side/Rear) | 0/1 | 0/1 | 0/1 | 0/1 | |
| Design | Front Color | Black | Black | Black | Black | |
| | Stand Type | Square | Square | Square | Square | |
| | Swivel (Left/Right) | N/A | N/A | Yes (20/20, 60/60, 90/90) | Yes (20/20, 60/60, 90/90) | |
| Dimensions (W x H x D) | Set Size without Stand - (WxHxD) (mm/in) | 561.8 x 3491 x 65.2 / 22.1" x 13.7" x 2.6" | 643.4 x 396.5 x 62.9 / 25.0" x 15.6" x 2.5" | 745.4 x 442.2 x 69.0 / 29.3" x 17.4" x 2.7" | 922.7 x 530.7 x 72.0 / 36.3" x 20.9" x 2.8" | |
| | Set Size with Stand (WxHxD) (mm/in) | 561.8 x 384.2 x 163.8 / 22.1" x 15.1" x 6.4" | 643.4 x 435.0 x 163.3 / 25.0" x 17.1" x 6.4" | 745.4 x 484.2 x 192.6 / 29.3" x 19.1" x 7.6" | 922.7 x 582.3 x 226.5 / 36.3" x 22.9" x 8.9" | |
| | Package Size (WxHxD) (mm/inch) | 743.0 x 407.0 x 114.0 / 29.3" x 16.0" x 4.5" | 815.0 x 463.0 x 108.0 / 32.1" x 18.2" x 4.3" | 923.0 x 539.0 x 142.0 / 36.3" x 21.2" x 5.6" | 1097.0 x 614.0 x 143.0 / 43.2" x 24.2" x 5.6" | |
| Weight | Set Weight without Stand (kg / lbs) | 3.9 / 8.6 | 3.8 / 8.4 | 4.3 / 9.5 | 6.8 / 15.0 | |
| | Set Weight with Stand (kg / lbs) | 4.1 / 9.0 | 4.2 / 9.3 | 5.8 / 12.8 | 9.7 / 21.4 | |
| | Package Weight (kg / lbs) | 5.1 / 11.2 | 5.4 / 11.9 | 8.3 / 18.3 | 12 / 26.5 | |
| Power | Power Supply (V) | AC110-120V 60Hz | AC110-120V 60Hz | AC110-120V 60Hz | AC110-120V 60Hz | |
| Accessory | Remote Controller Model | TM1240A | TM1240A | TM1240A | TM1240A | |
| | Batteries (for Remote Control) | Yes | Yes | Yes | Yes | |
| | Mini Wall Mount Support | N/A | N/A | N/A | Yes | |
| | Vesa Wall Mount Support | Yes | Yes | Yes | Yes | |
| | Power Cable | Yes | Yes | Yes | Yes | |
| | Quick Install Guide | Yes | Yes | Yes | Yes | |
| | Data Cable | Yes | Yes | Yes | Yes | |
| | Stand Mount Kit | N/A | Yes | Yes | Yes | |
| | Security Screws | N/A | Yes | Yes | Yes | |
| VESA Standard | VESA Size (mm) | 75 x 75 | 100 x 100 | 100 x 100 | 200 x 200 | |
| | Wall Mount Screw Size | M4 | M4 | M4 | M8 | |

Samsung NE470 Series Hospitality TVs

NE470 Series Key Specifications For complete product specifications, visit samsung.com/hospitality

| | | HG43NE470SFXZA | HG49NE470HFXZA | HG55NE470BFXZA | |
|--|---|---|---|---|------------------|
| Display | Backlight | LED | LED | LED | |
| | Screen Size (Diagonal) | 43" | 49" | 55" | |
| | HD/FHD | FHD | FHD | FHD | |
| Video | Resolution | 1920 x 1080 | 1920 x 1080 | 1920 x 1080 | |
| | Picture Engine | HyperReal | HyperReal | HyperReal | |
| | Dynamic Contrast Ratio | Mega Contrast | Mega Contrast | Mega Contrast | |
| | Wide Color Enhancer (Plus) | Yes | Yes | Yes | |
| Audio | Film Mode | Yes | Yes | Yes | |
| | Dolby Digital Plus | Yes | Yes | Yes | |
| | DTS Codec | Yes | No | Yes | |
| | Sound Output (RMS) | 20W (L:10W, R:10W) | 20W (L:10W, R:10W) | 20W (L:10W, R:10W) | |
| SMART TV | Speaker Type | ZCH (Down Firing w/Base Reflex) | ZCH (Down Firing w/Base Reflex) | ZCH (Down Firing w/Base Reflex) | |
| | Wall Mount Sound Mode | Yes | No | Yes | |
| Features | Smart TV Type | Non Smart | Non Smart | Non Smart | |
| | Accessibility | Voice Guide | Voice Guide | Voice Guide | |
| | Digital Clean View | Yes | Yes | Yes | |
| | Auto Channel Search | Yes | Yes | Yes | |
| | Auto Power Off | Yes | Yes | Yes | |
| | Caption (Subtitle) | Yes | Yes | Yes | |
| | ConnectShare™ (USB 2.0) | Yes | Yes | Yes | |
| | EPG | Yes | Yes | Yes | |
| | Game Mode | Yes | Yes | Yes | |
| | OSD Language | English, Spanish, French | English, Spanish, French | English, Spanish, French | |
| | Picture-In-Picture | Yes | Yes | Yes | |
| | System | Digital Broadcasting | ATSC / Clear QAM | ATSC / Clear QAM | ATSC / Clear QAM |
| | | Analog Tuner | Yes | Yes | Yes |
| Hospitality Features | Samsung LYNK™ REACH (RF) | REACH 4.0 | REACH 4.0 | REACH 4.0 | |
| | Samsung LYNK™ REACH RF Modulator Compatibility | Yes | Yes | Yes | |
| | Hospitality Home Menu | Home Menu 2015 | Home Menu 2015 | Home Menu 2015 | |
| | Hospitality Plug&Play (Easy Setup) | Yes | Yes | Yes | |
| | Auto Source Mode | Yes | Yes | Yes | |
| | Power On Mode | Yes | Yes | Yes | |
| | Hotel Channel List | Yes | Yes | Yes | |
| | Channel Menu Display | Yes | Yes | Yes | |
| | Mixed Channel List (ATSC, DVB-T/T2/C/S2, Analog) | Yes | Yes | Yes | |
| | My Channel | Yes | Yes | Yes | |
| | Energy Saving Mode (BLU Control) | Yes | Yes | Yes | |
| | Logo Display with Timer Out Setting (BMP/Movie) | Yes | Yes | Yes | |
| | Welcome Message | Yes | Yes | Yes | |
| | RJ12 / IR Pass Through | Yes | Yes | Yes | |
| | Clock Back Up Power Supply | Yes | Yes | Yes | |
| | Software Clock | Yes | Yes | Yes | |
| | Multi Code Remote Control | Yes | Yes | Yes | |
| | Screwed Battery Cover | Yes | Yes | Yes | |
| | Sound Bar Compatibility | Yes | Yes | Yes | |
| | Music Mode (Input: PC/AV/Component/HDMI) | Yes | Yes | Yes | |
| | Music Mode Backlight On/Off | Yes | Yes | Yes | |
| USB Cloning | Yes | Yes | Yes | | |
| Smooovie Compatibility | Yes | Yes | Yes | | |
| On/Off Timer (Schedule) | Yes | Yes | Yes | | |
| Wake-up Timer (Alarm) | Yes | Yes | Yes | | |
| Samsung LYNK™ DRM | Yes | Yes | Yes | | |
| Security Mode | Yes | Yes | Yes | | |
| S/W EPG (Solution EPG) | Yes | Yes | Yes | | |
| Input & Output | HDMI (Side/Rear) | 1/1 | 2/0 | 1/1 | |
| | USB (Side/Rear) | 1/0 | 1/0 | 1/0 | |
| | Composite In (AV) (Side/Rear) | 1/0 | 1/0 | 1/0 | |
| | Audio Out (Mini Jack / LR) (Side/Rear) | 0/1 | 0/1 | 0/1 | |
| | RF In (Terrestrial / Cable input / Satellite Input) (Side/Rear) | 0/1 | 0/1 | 0/1 | |
| | Ex-Link (RS232C) | Common (RJP) | Common (RJP) | Common (RJP) | |
| | HDMI A / Return Ch. Support | Yes | Yes | Yes | |
| | Anynet+ (HDMI-CEC) | Yes | Yes | Yes | |
| | RJ12 (Side/Rear) | 0/1 | 0/1 | 0/1 | |
| RJP Jack (For Remote Jackpack) (Side/Rear) | 0/1 | 0/1 | 0/1 | | |
| Design | Front Color | Black | Black | Black | |
| | Stand Type | Square | Square | Square | |
| | Swivel (Left/Right) | Yes (20/20, 60/60, 90/90) | Yes (20/20, 60/60, 90/90) | Yes (20/20, 60/60, 90/90) | |
| Dimensions (W x H x D) | Set Size without Stand - (WxHxD) (mm/in) | 985.5 x 575.3 x 72.2 / 38.8" x 22.6" x 2.8" | 1118.8 x 650.0 x 74.2 / 44.0" x 25.6" x 2.9" | 1231.6 x 708.6 x 68.6 / 48.5" x 27.9" x 2.7" | |
| | Set Size with Stand (WxHxD) (mm/in) | 985.5 x 624.2 x 226.5 / 38.8" x 24.6" x 8.9" | 1118.8 x 700.1 x 226.5 / 44.0" x 27.6" x 8.9" | 1231.6 x 763.5 x 226.4 / 48.5" x 30.1" x 8.9" | |
| | Package Size (WxHxD) (mm/inch) | 1162.0 x 649.0 x 142.0 / 45.7" x 25.6" x 5.6" | 1336.0 x 757.0 x 171.0 / 52.6" x 29.8" x 6.7" | 1470.0 x 815.0 x 145.0 / 57.9" x 32.1" x 5.7" | |
| Weight | Set Weight without Stand (kg / lbs) | 7.7 / 17.0 | 10.3 / 22.7 | 13.6 / 30.0 | |
| | Set Weight with Stand (kg / lbs) | 10.7 / 23.6 | 13.3 / 29.3 | 16.5 / 36.4 | |
| | Package Weight (kg / lbs) | 12.8 / 28.2 | 18.0 / 39.7 | 21.3 / 47.0 | |
| Power | Power Supply (V) | AC110-120V 60Hz | AC110-120V 50/60Hz | AC110-120V 60Hz | |
| Accessory | Remote Controller Model | TM1240A | TM1240A | TM1240A | |
| | Batteries (for Remote Control) | Yes | Yes | Yes | |
| | Mini Wall Mount Support | Yes | Yes | Yes | |
| | Vesa Wall Mount Support | Yes | Yes | Yes | |
| | Power Cable | Yes | Yes | Yes | |
| | Quick Install Guide | Yes | Yes | Yes | |
| | Data Cable | Yes | Yes | Yes | |
| | Stand Mount Kit | Yes | Yes | Yes | |
| | Security Screws | Yes | Yes | Yes | |
| VESA Standard | VESA Size (mm) | 200 x 200 | 200 x 200 | 400 x 400 | |
| | Wall Mount Screw Size | M8 | M8 | M8 | |

Learn More

samsung.com/business insights.samsung.com samsung.com/hospitality

Product Support

1-866-SAM4BIZ

Follow Us

[youtube.com/samsungbizusa](https://www.youtube.com/samsungbizusa) [@SamsungBizUSA](https://twitter.com/SamsungBizUSA)

SAMSUNG