

Description	Assembly Letter	Quantity
<b>Floor</b>		
Front Left Floor	A	1
Front Right Floor	U	1
Back Left Floor	B	1
Back Right Floor	W	1
<b>Walls</b>		
Left Side Panel	C	2
Right Side Panel	D	2
Left Back Panel	E	1
Right Back Panel	G	1
Left Front Panel	H	1
Right Front Panel	J	1
Wall Connector	Q	14
<b>Doors</b>		
Left Door	AK	1
Right Door	AF	1
Lock Hasp	X	1
Window for Door	LL	2
Gasket for Door Window	MM	2
Door Reinforcement	NN	2
Hinge Reinforcement	PP	2
Handle Kit – See Handle Assembly Instructions	QQ	1
Spring Bolt Kit – See Handle Assembly Instructions	SS	1
<b>Roof</b>		
Left Roof Panel	N	1
Left Skylight Roof Panel	AN	1
Right Roof Panel	P	1
Right Skylight Roof Panel	AP	1
Gable	M	2
Ridge Beam	R	1
Roof Connector	T	16
Skylight with Gasket Installed	L	2
<b>Hardware</b>		
#14 x 1.0" Combo Pan Head Screw	AA	40
#14 x 5/8" Combo Pan Head Screw	JJ	12
#8 x 1/2" Combo Pan Head Screw	KK	30
#8 SAE Flat Washer	TT	30
1/4-20 x 0.5" Combo Round Head Bolt	BB	2
1/4-20 Flat Washer Zinc	CC	2
1/4-Hex Nut	DD	2
Roof Pin	EE	4

- Required Tools**
- Safety Glasses
  - Rubber Mallet
  - Phillips Screw Driver
  - Drill
  - Pliers
  - Liquid Soap
  - (2) Step Stools/Stepladders
- Two Person Assembly**
- 

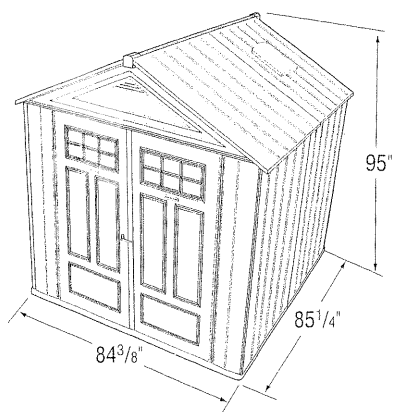

# 3784

## BIG MAX 7' x 7' RESIN STORAGE BUILDING ASSEMBLY

**Pre-Assembly:**

- Review ALL assembly steps before beginning construction.
- Review the parts list and make sure that no parts are missing.
- Level the area where the shed will be located.
  - Areas of "fill dirt" should be tamped/compacted to prevent settling/sinking.
  - If a foundation is desired, it should be constructed before assembly.

**NOTE:**

To simplify assembly and to ensure proper engagement of all components, apply a mild detergent to dovetail and snap fits before assembling.

# 1

Level construction site before beginning assembly of shed. A foundation may be constructed if desired.

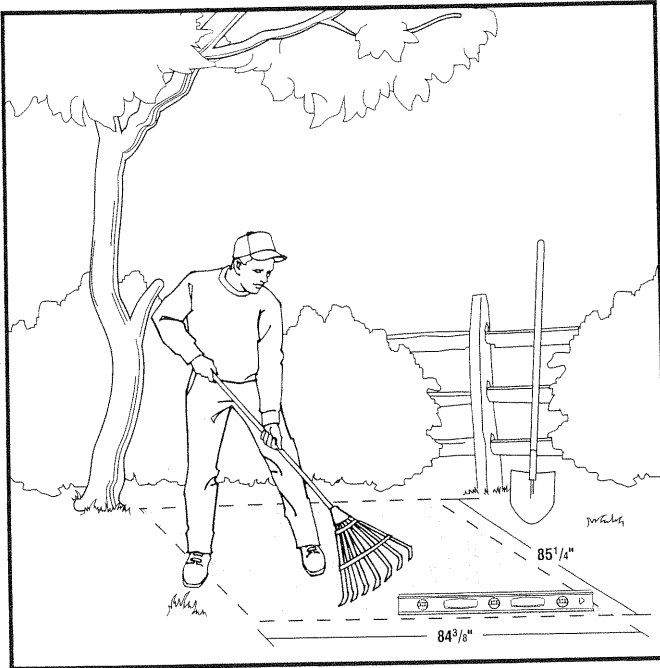

## FLOOR PLAN:

Size the construction site to fit the entire floor.

## OPTIONAL STEP:

If desired, recessed anchor locations (6 places) can be used to anchor the shed floor to a foundation after Step 4.

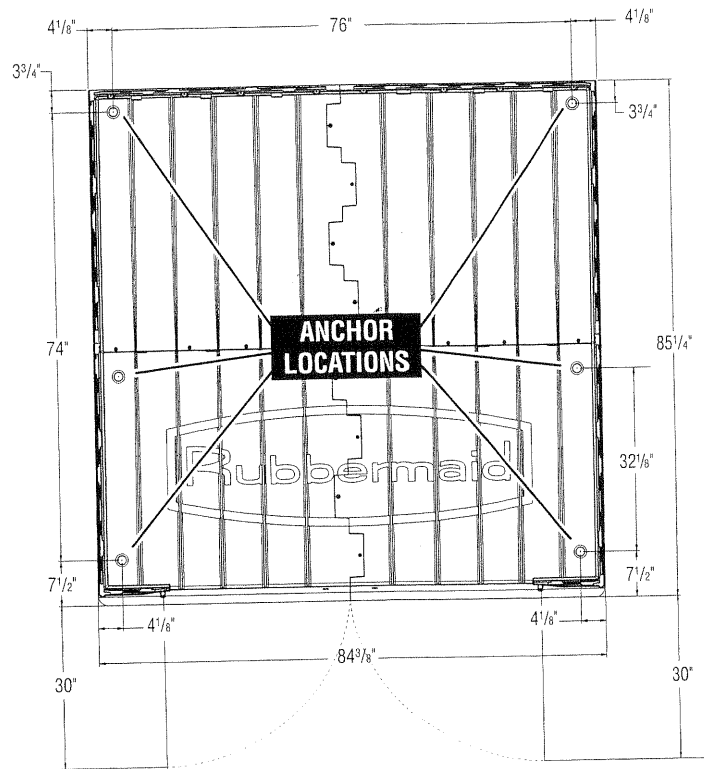

# 2

Connect Front Left Floor (A) to Front Right Floor (U), install Screws (AA) 4 places.

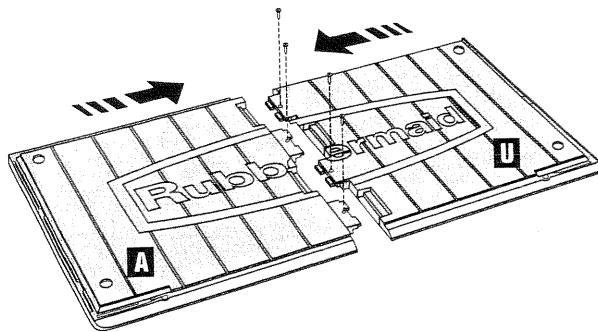
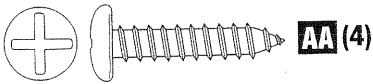

# 3

Connect Back Left Floor (B) to Back Right Floor (W), install Screws (AA) 4 places.

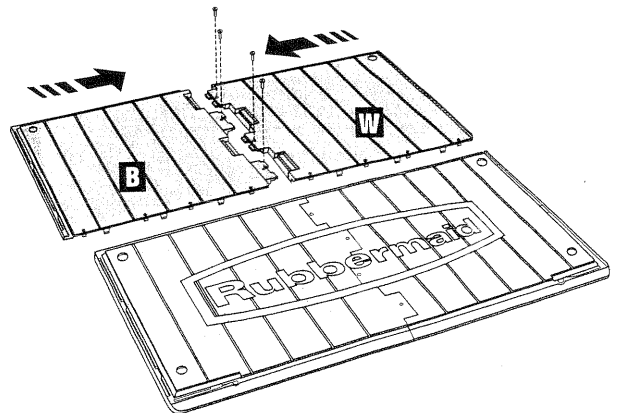
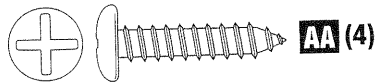

Caution: When installing screws do not overtighten.

Caution: When installing screws do not overtighten.

**4**

Place the Front Floor Assembly on the leveled construction site. Connect the Back Floor to the Front Floor, install Screws (AA) 8 Places.

**OPTIONAL STEP:**

If desired, recessed anchor locations (6 places) can be used to anchor the shed floor to a foundation, see Step 1.

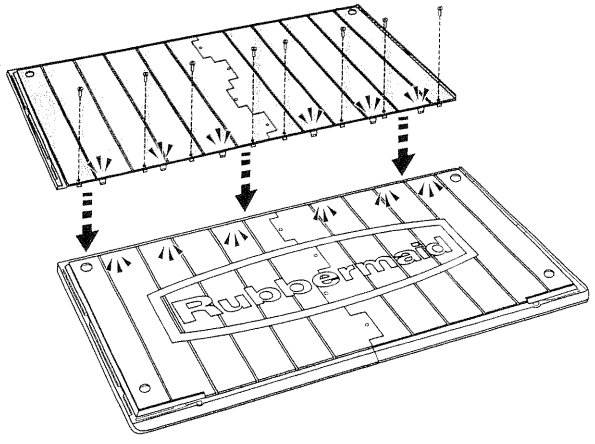
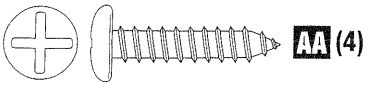

**5**

Using a screwdriver, punch out the screw holes on the top of Left Side Panel (C) 2 Places. Connect Left Side Panel (C) into Front Left Floor (A).

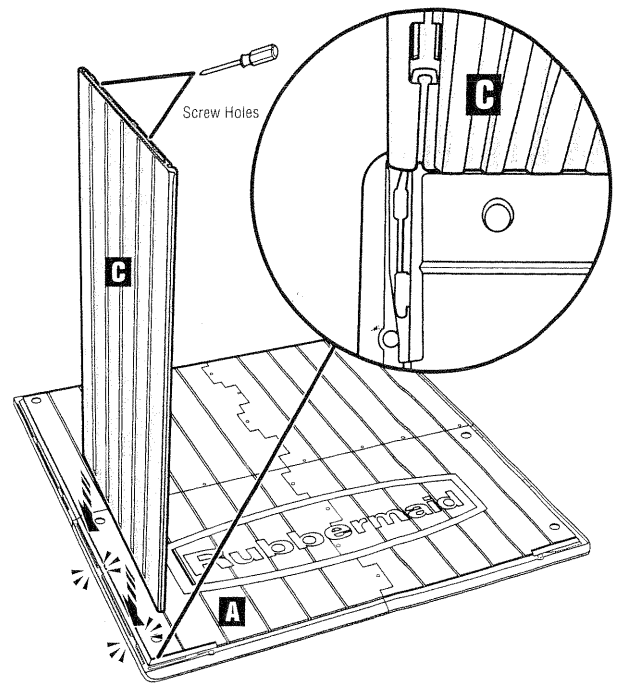

**Caution: When installing screws do not overtighten.**

**6**

Lubricate dovetails on Left Front Panel (H) 4 places with liquid soap. Connect Left Front Panel (H) into dovetails of Left Side Panel (C), engage snaps on bottom of Left Front Panel (H) into Front Left Floor (A).

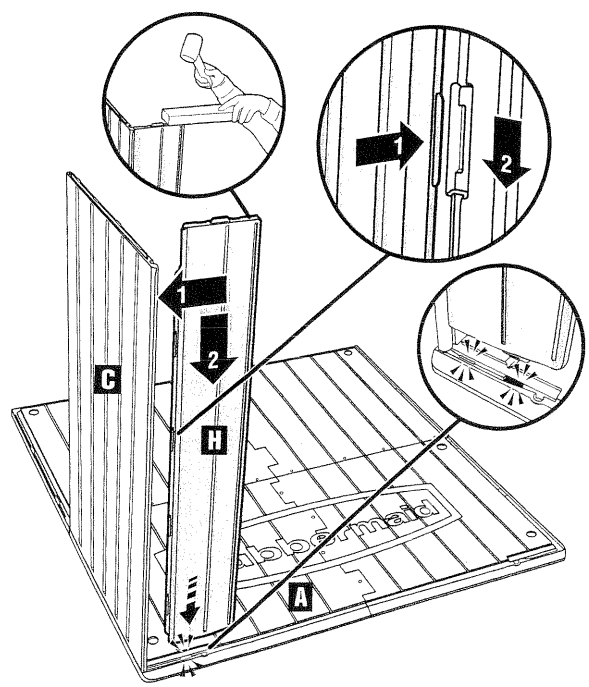

**7**

Using a screwdriver, punch out the screw holes on the top of Left Side Panel (C) 2 Places. Align lap joint between Left Side Panels. Connect Left Side Panel (C) into Back Left Floor (B).

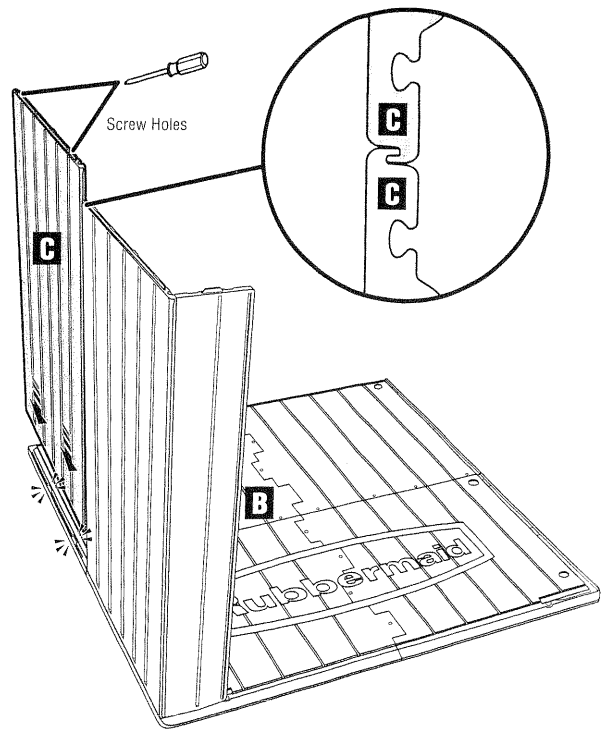

**8**

Install Wall Connectors (Q) 5 places.

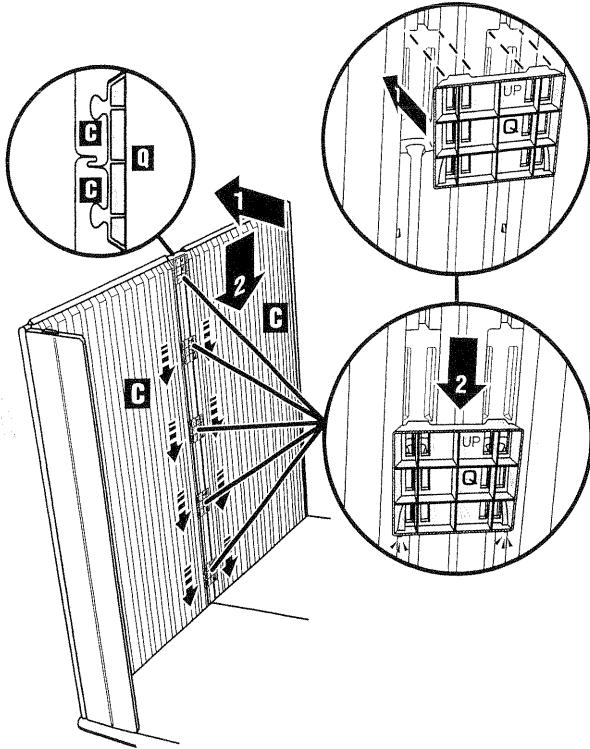
**9**

Lubricate dovetails on Left Back Panel (E) 4 places with liquid soap. Connect Left Back Panel (E) into dovetails of Left Side Panel (C), engage snaps on bottom of Left Back Panel (E) into Back Left Floor (B).

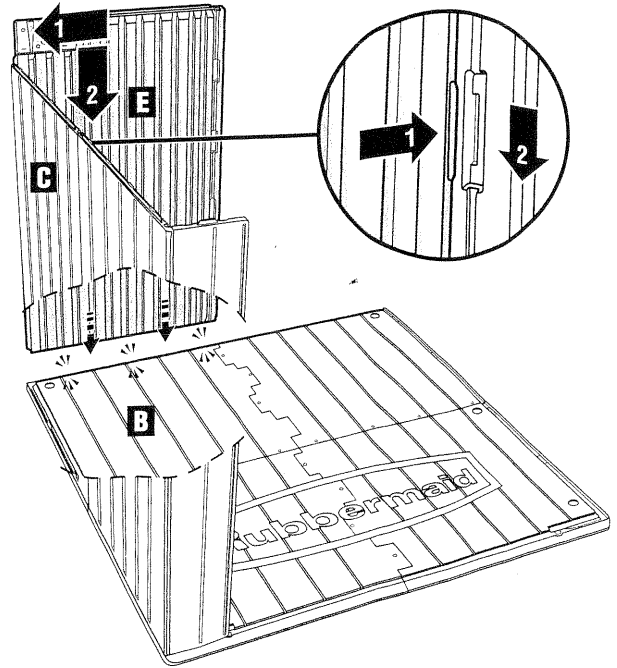
**10**

Repeat Steps 5-9 to assemble right side of shed. Continue to Step 11.

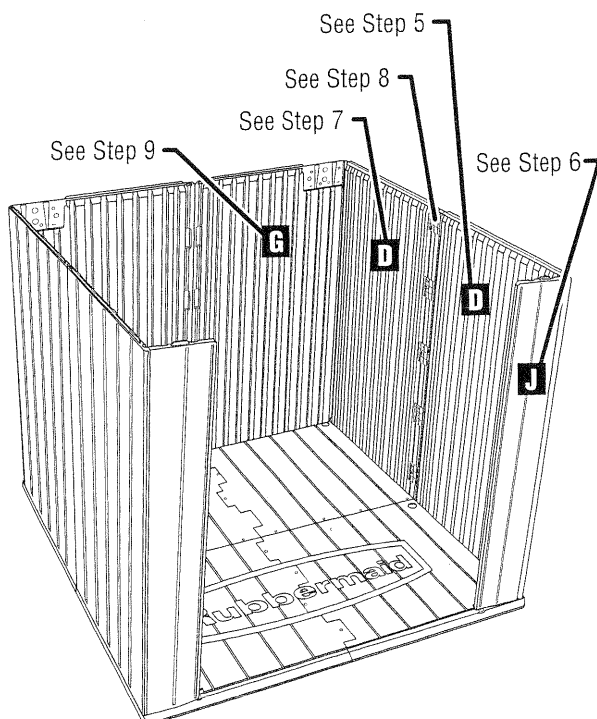
**11**

Engage lap joint between Left Back Panel (E) and Right Back Panel (G) and install Wall Connectors (Q) 4 places.

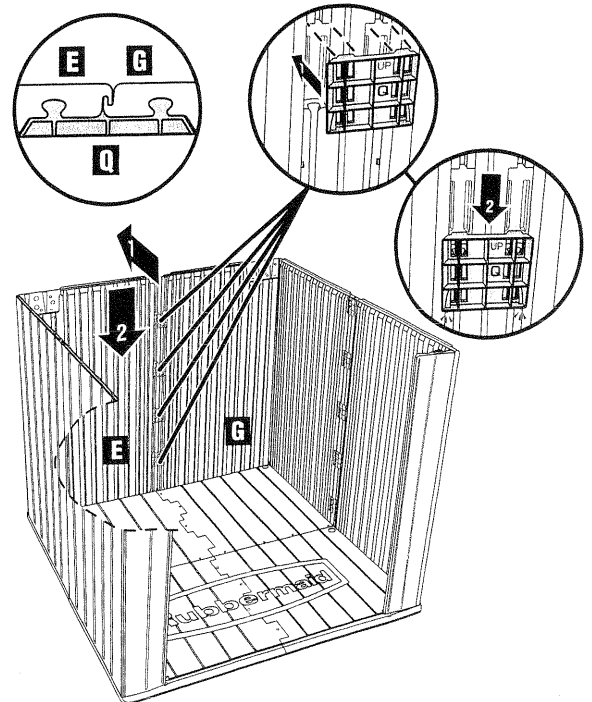

**12**

Install Gable (M) onto top of back wall engaging the 2 dovetails and snaps on the back panel and the dovetail on the side panel on both the left and right sides of the shed.

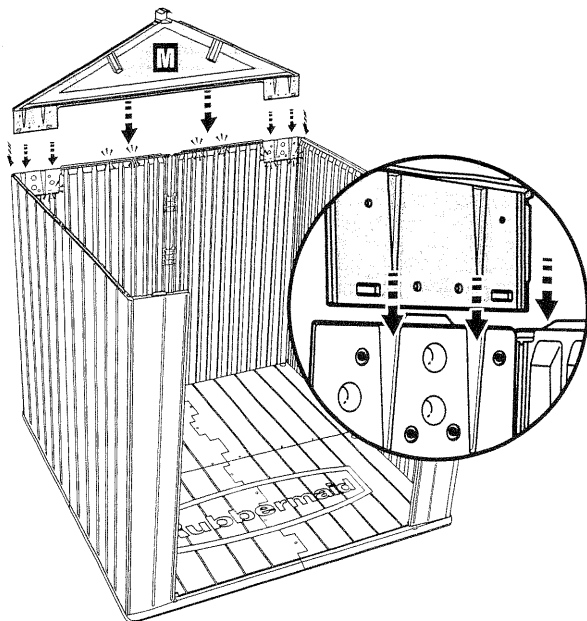
**13**

Install Gable (M) onto top of front wall engaging the 2 dovetails on the front panel and the dovetail on the side panel on both the left and right sides of the shed.  
**DO NOT ENGAGE THE SNAPS.**

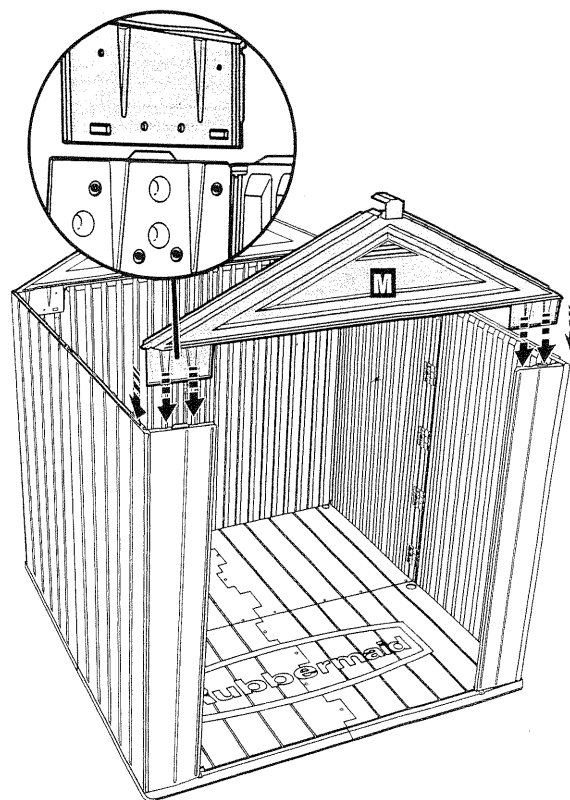
**14**

Set the Left Door Panel (AK) face down on the ground.  
Slide the Hinge Reinforcement (PP) into the hole on the top door pin. The Hinge Reinforcement (PP) will slide in until it is below the end of the door pin.

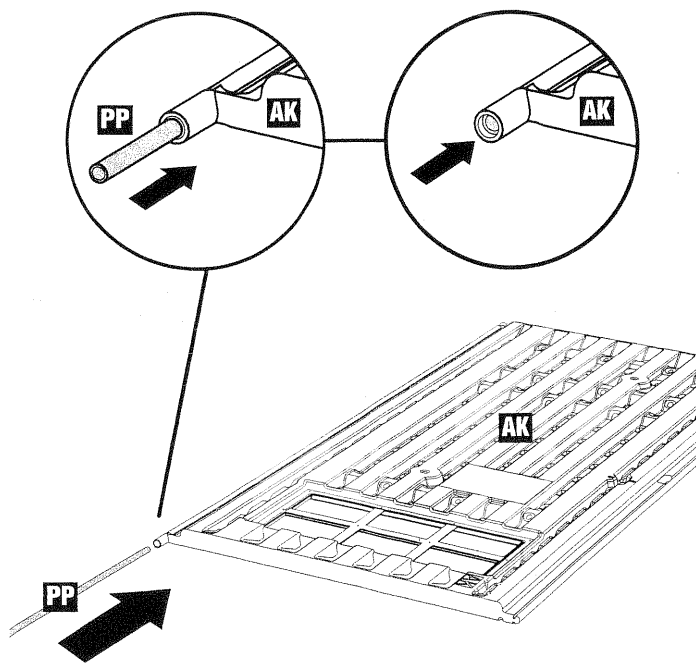
**15**

Starting at the top of the door, slide the Door Reinforcement (NN) onto the groove located on the handle side of the door. The Door Reinforcement (NN) will slide to the stop at the bottom of the door.

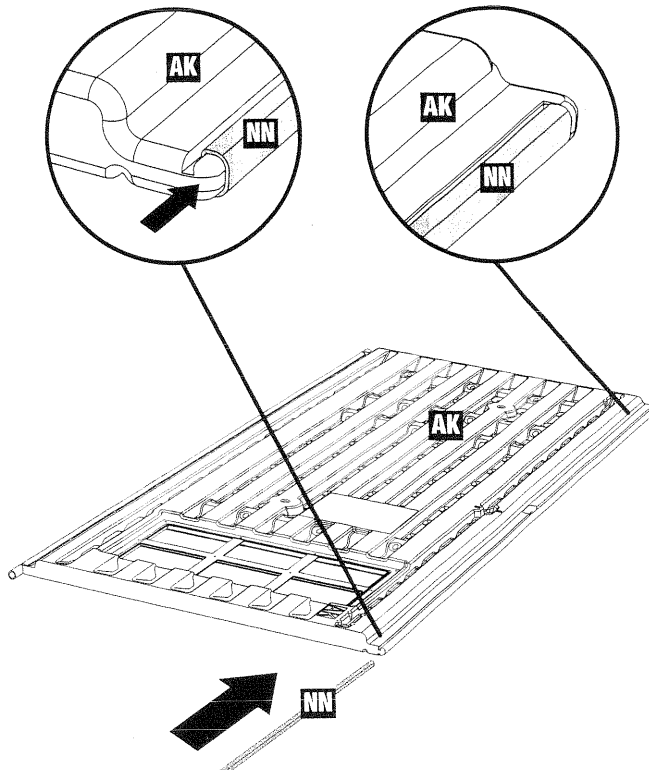

# 16

Install the Gasket (MM) into the gasket groove in the door. Start at the top and middle, by pushing the gasket into the groove. Continue until the Gasket (MM) is fully installed. There will be a small gap between the ends of the gasket.

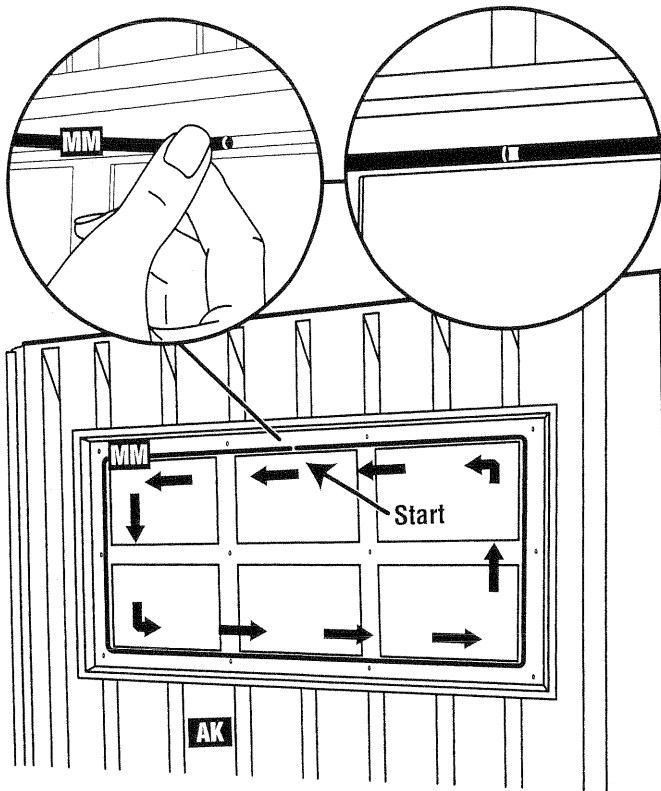

# 17

Install the Window (LL) onto the door by matching up the holes and installing the Screws (KK) and Washers (TT) 15 places. The "frosted" side of the window should be touching the gasket. Install screws in order starting at position 1. Repeat steps 14-17 for Right Door Panel (AF).

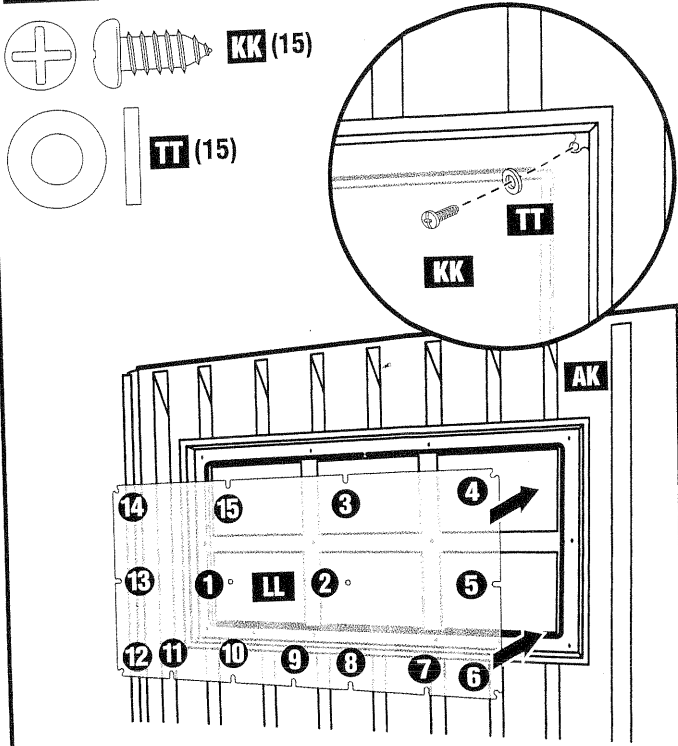

**Caution:** Tighten screws only enough to compress gasket. Do not overtighten.

# 18

Install Left Door Panel (AK) inserting the lower hinge pin into Front Left Floor (A) socket, lift the left end of the Gable (M) enough to insert the top hinge pin on Left Door Panel (AK) into the Gable (M) socket.

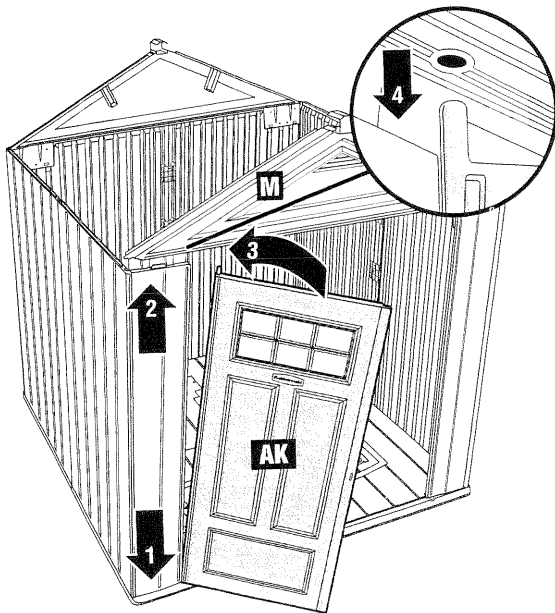

# 19

Install Right Door Panel (AF) inserting the lower hinge pin into Front Right Floor (U) socket, lift the right end of the Gable (M) enough to insert the top hinge pin on Right Door Panel (AF) into the Gable (M) socket.

Install Lock Hasp (X) on interior side of Right Door Panel (AF). Engage Gable (M) snaps on front wall.

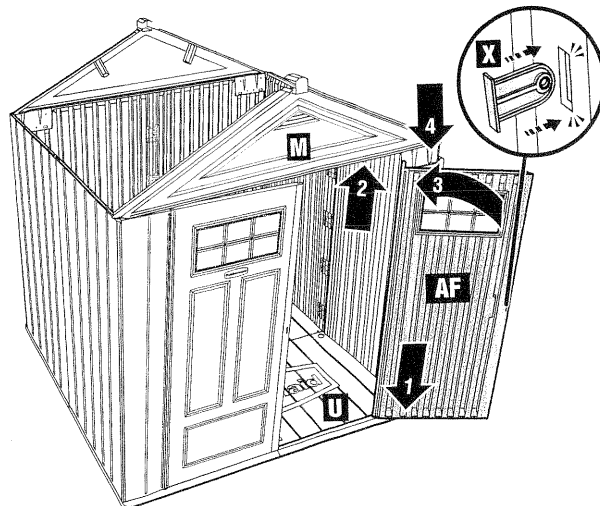

# 20

Place Ridge Beam (R) into cups at the top of each Gable (M).

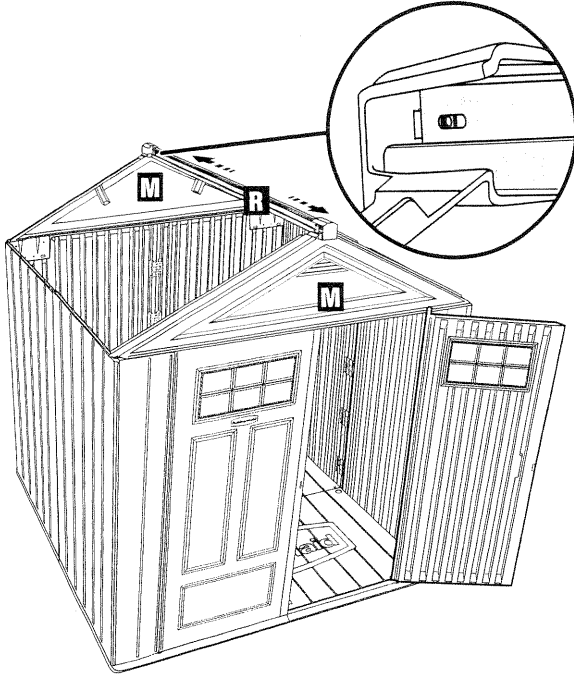

# 21

Align slots in Ridge Beam (R) with holes in Gable (M) tabs, install Bolt (BB), Washer (CC), and Nut (DD) 1 place. **ONLY TIGHTEN NUT 'FINGER' TIGHT.**

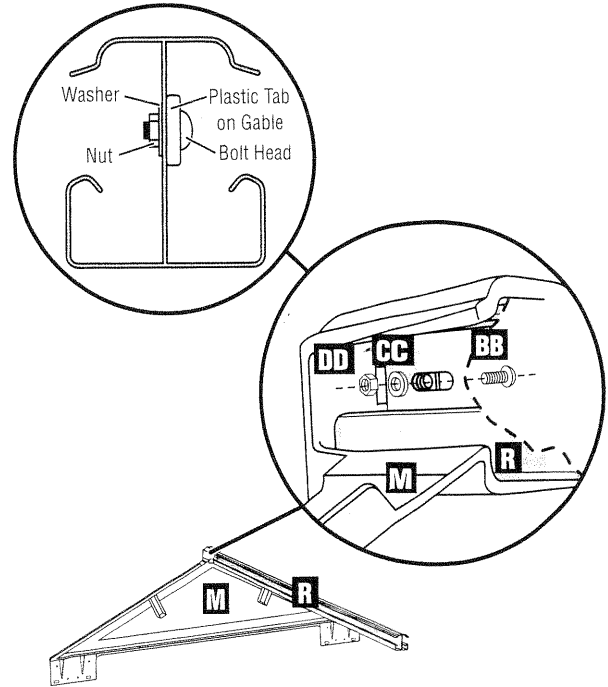

# 22

## OPTIONAL STEP:

Install (2) 2" x 6" x 82.5" pieces of lumber into Gable (M).  
(Lumber not included.)

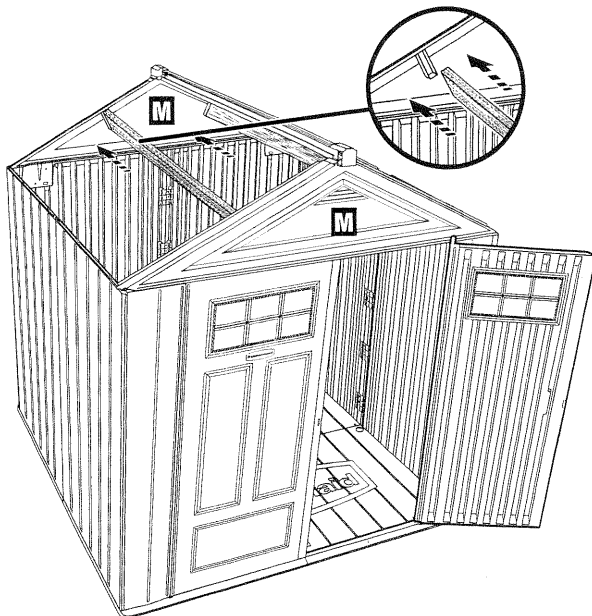

# 23

Align slots in Ridge Beam (R) with holes in Gable (M) tabs, install Bolt (BB), Washer (CC), and Nut (DD) 1 place. **ONLY TIGHTEN NUT 'FINGER' TIGHT.**

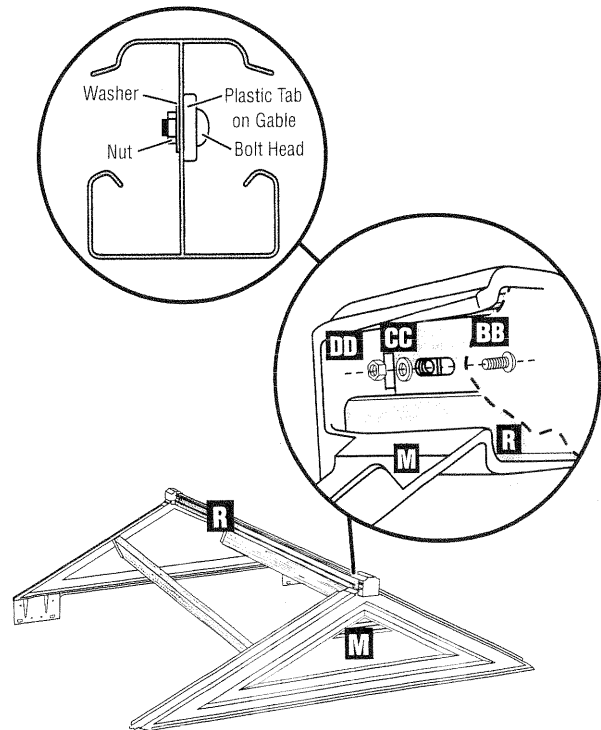

**Note:** Highly recommended for areas of extreme snow or extreme heat. Usage of the lumber supports is optional. The Big Max Shed is designed to function properly without them; however, the lumber provides extra roof support in extreme conditions.

# 24

Using a screwdriver, punch out the screwholes on the Left Skylight Roof Panel (AN) 6 places.  
Attach the Skylight (L) to the Left Skylight Roof Panel (AN), install Screws (JJ) 6 places.

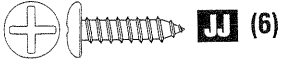

**Caution:** When installing screws do not overtighten.

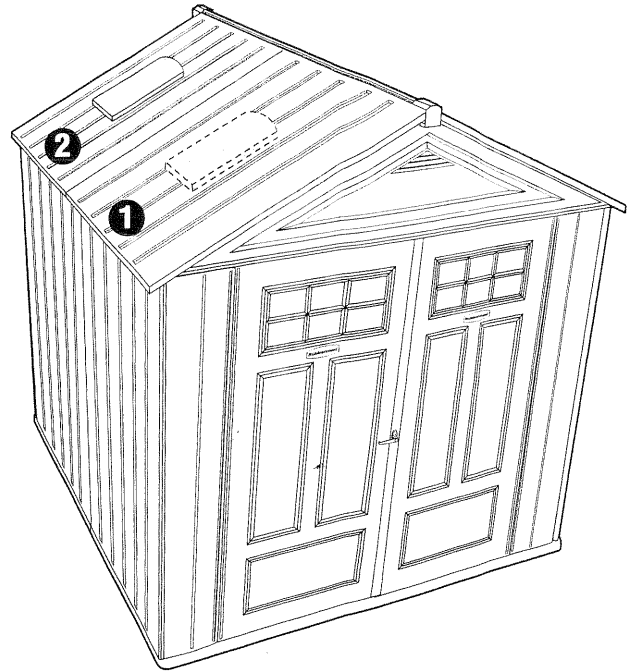
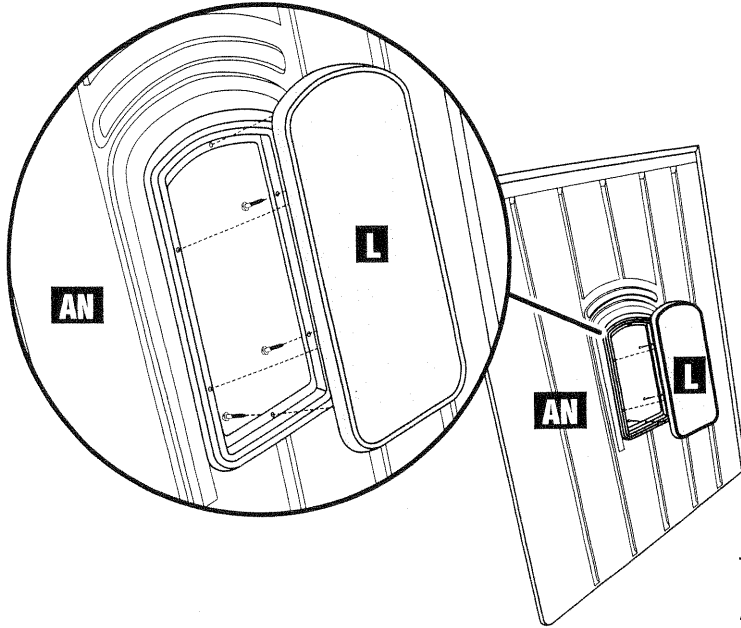

The Skylight Roof Panel can be assembled in 1 of 2 different positions  
Assembly instructions show the Skylight Roof Panel being assembled in position 2.

# 25

Lubricate roof snaps on front Gable (M) 8 places.  
Raise the Left Roof Panel (N) onto the front left side of the shed assembly, the arrows on the roof panels should face the inside of the shed and point towards the Ridge Beam (R).

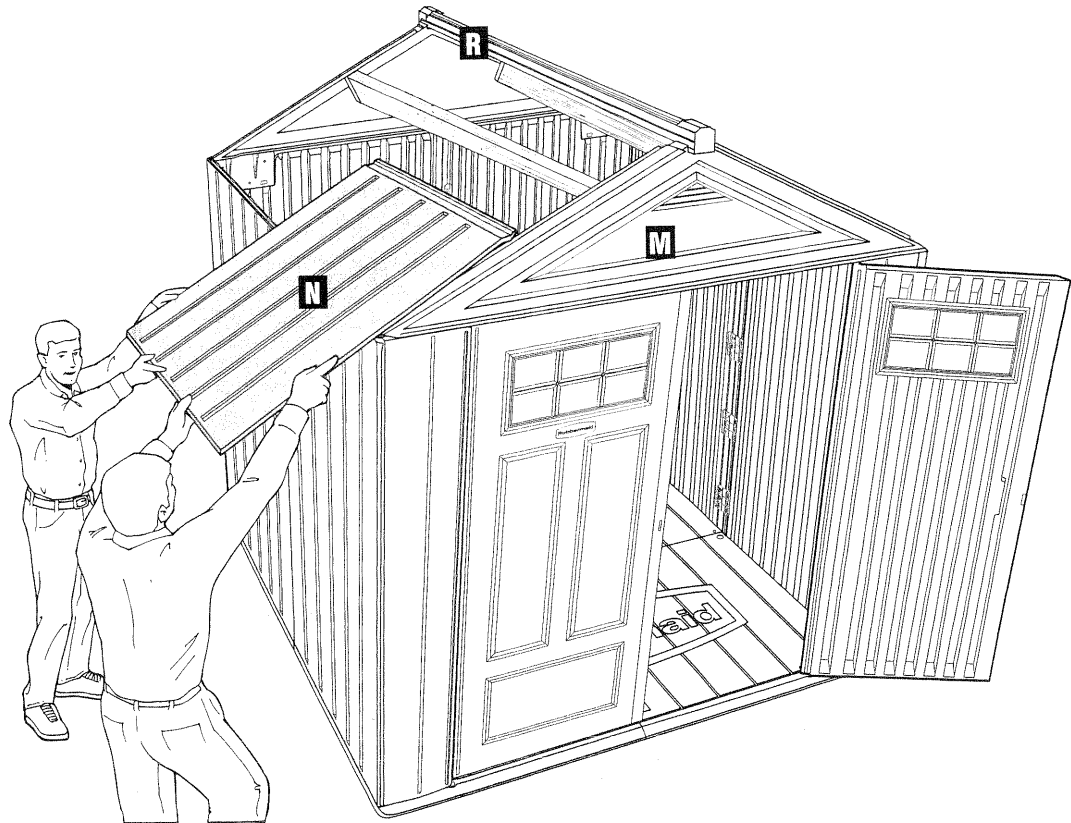



**26**

Using (2) step stools (1 inside shed, 1 outside shed), lift bottom of the roof panel above horizontal, guide the roof panel into the Ridge Beam (R), align the front Gable (M) rib with the channel in Left Roof Panel (N), engage Left Roof Panel (N) in Ridge Beam (R) by lowering the bottom of the roof panel onto the shed assembly (hold Ridge Beam (R) to prevent twisting). DO NOT SNAP ROOF DOWN.

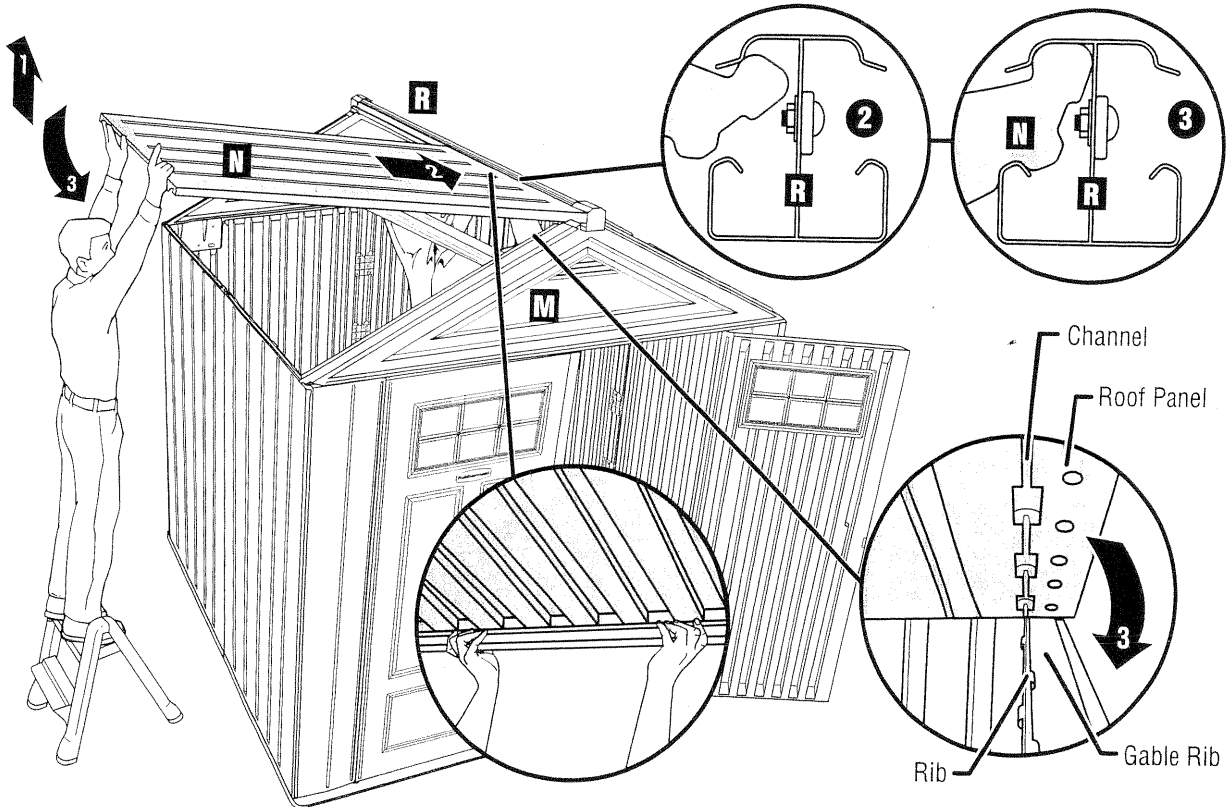
**27**

Lubricate roof snaps on Back Gable (M) 8 places. Raise the Left Skylight Roof Panel (AN) onto the back left side of the shed assembly, the arrows on the roof panel should face the inside of the shed and point towards the Ridge Beam (R).

Using (2) step stools (1 inside shed, 1 outside shed), lift bottom of the roof panel above horizontal, guide the roof panel into the Ridge Beam (R), align the back Gable (M) rib with the channel in Left Skylight Roof Panel (AN), engage Left Skylight Roof Panel (AN) in Ridge Beam (R) by lowering the bottom of the roof panel onto the shed assembly (hold Ridge Beam (R) to prevent twisting). DO NOT SNAP ROOF DOWN.

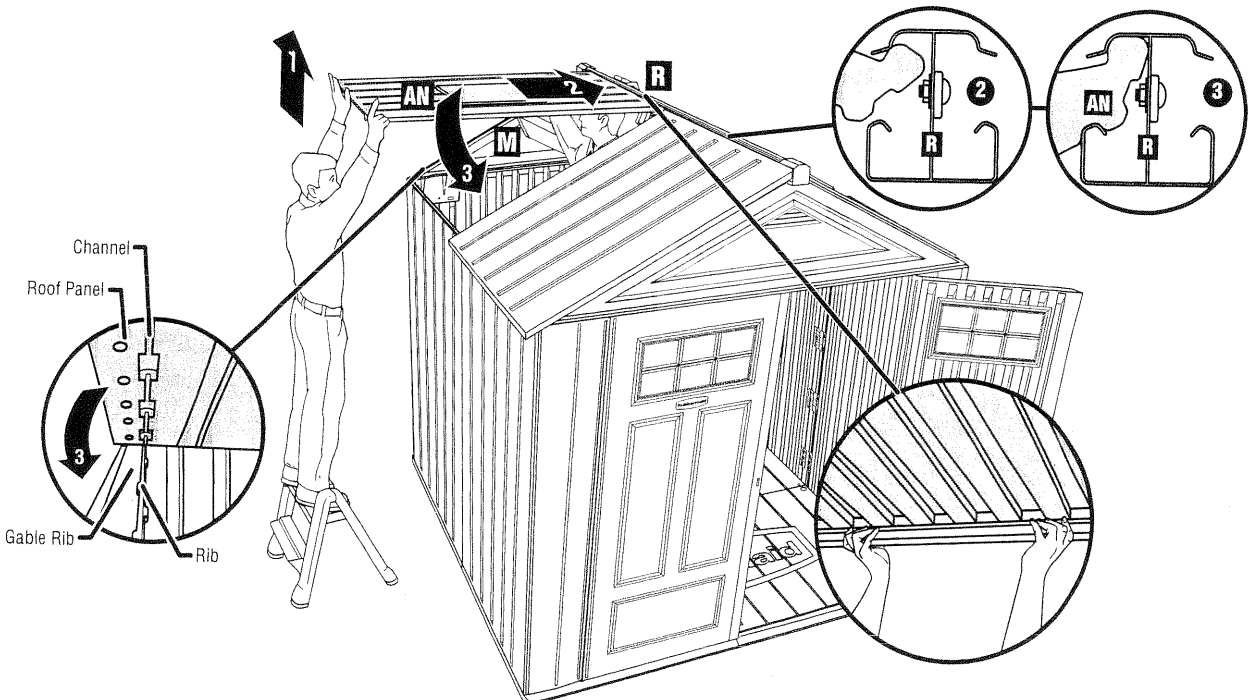

Install Roof Connectors (T) 4 places. You may need to lift the bottom of the roof panels to avoid the 2' x 6".

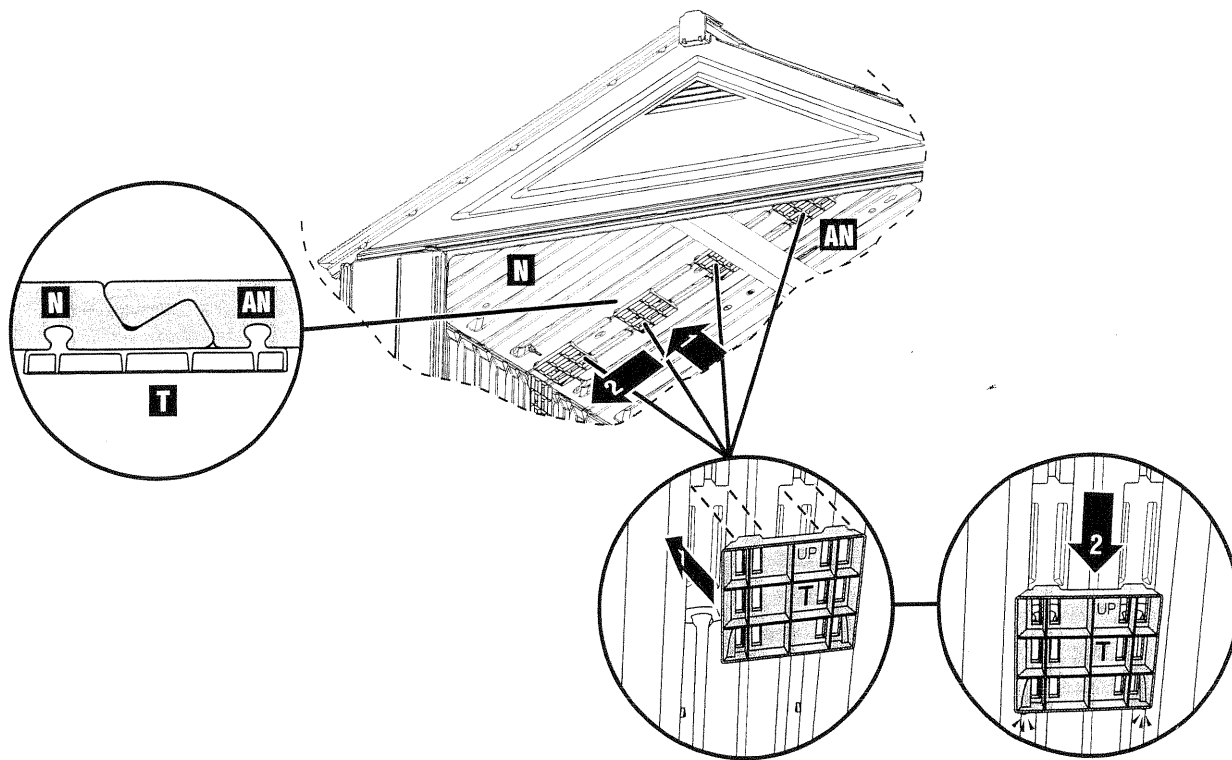

Engage all snaps between the roof panels and gables. Then engage all snaps between roof panels and wall panels.

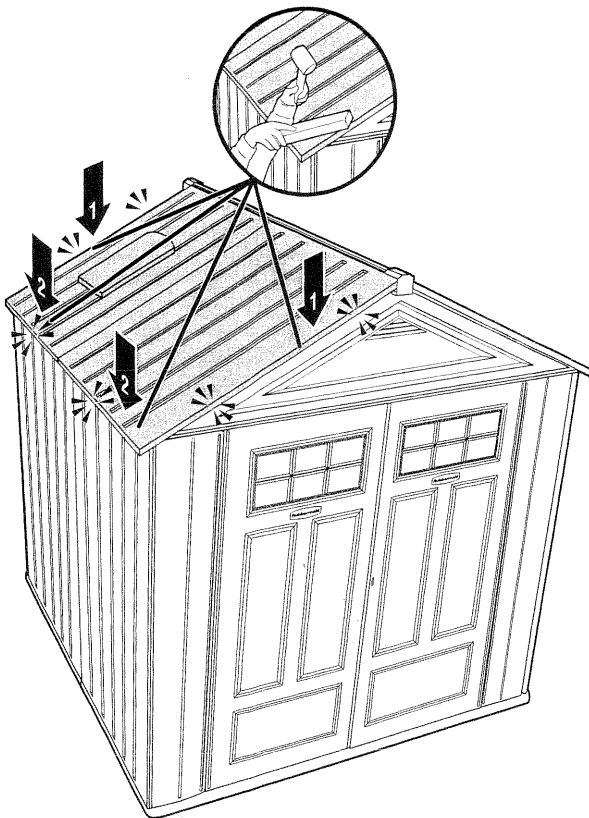

Repeat Steps 24-29 for right roof of shed.

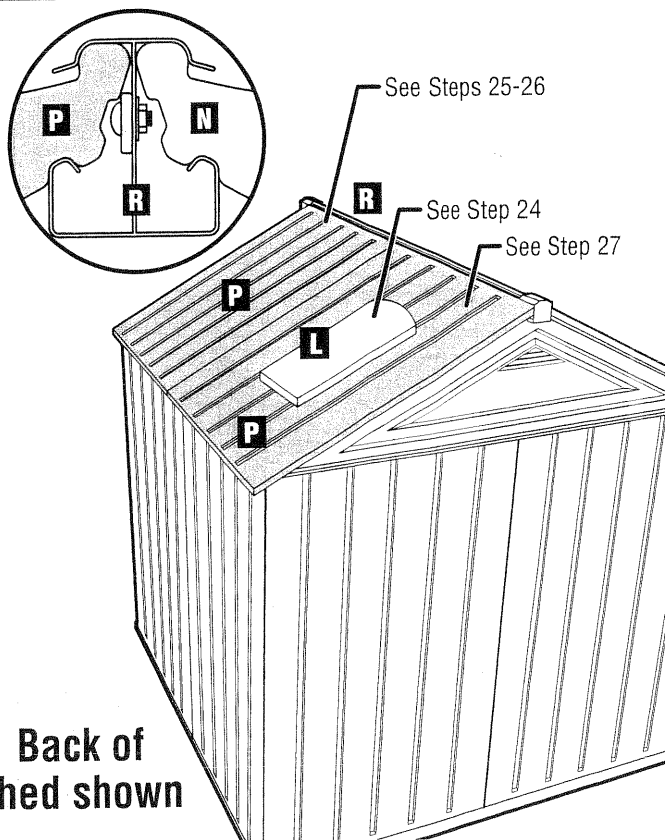

# 31

Install Screws (AA) 16 places in Gable (M).

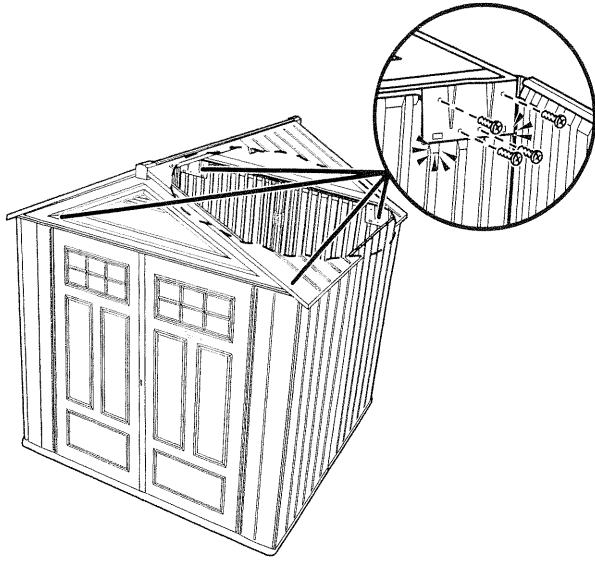
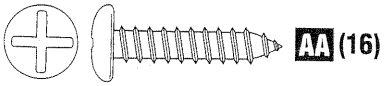

**Caution:** When installing screws do not overtighten.

# 32

While one person holds down the bottom of the roof, install screws (AA) 8 places in screw holes on the top of the Side Panels (C&D). Screws connect the Side Panels to the Roof Panels.

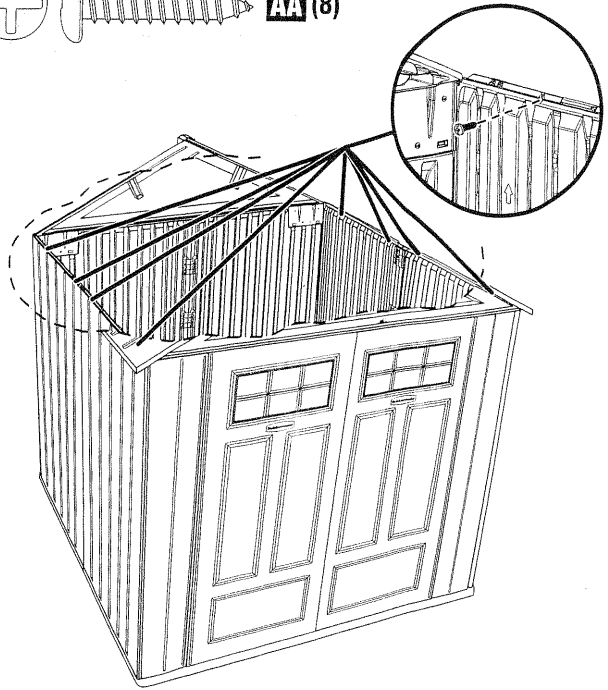
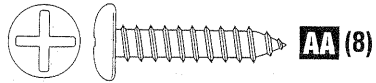

**Caution:** When installing screws do not overtighten.

# 33

Install Roof Pins (EE) 4 places connecting the Roof Panels to the Gables.

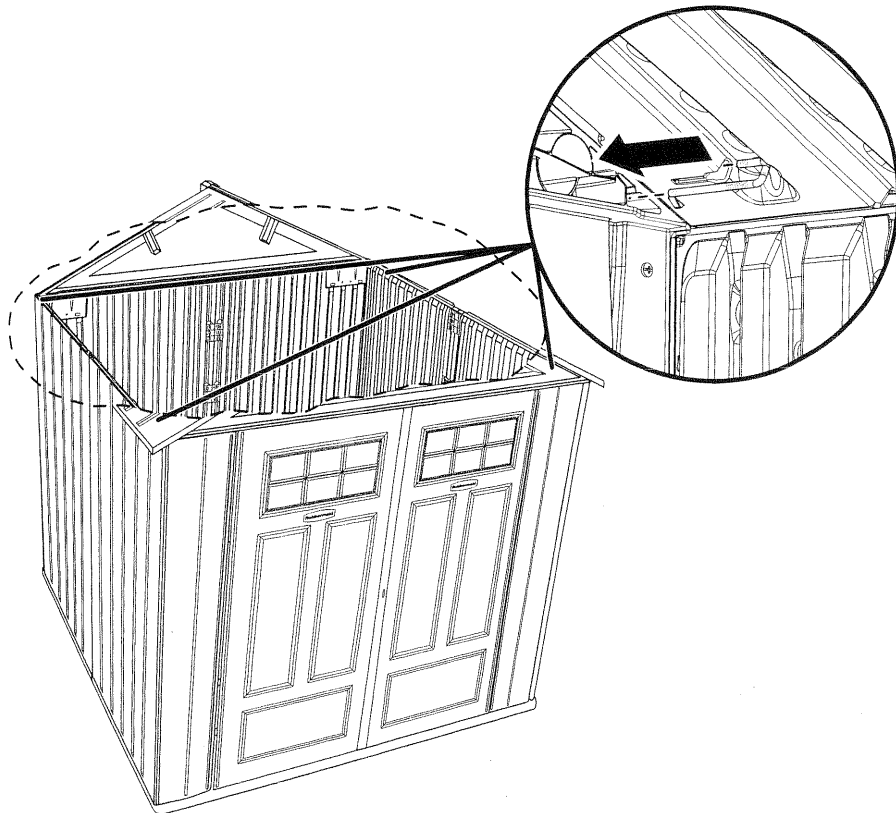
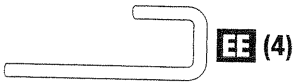

34

Open the Handle Kit (QQ) and Spring Bolt Kit (SS) and follow the enclosed instructions to assemble the Handle.

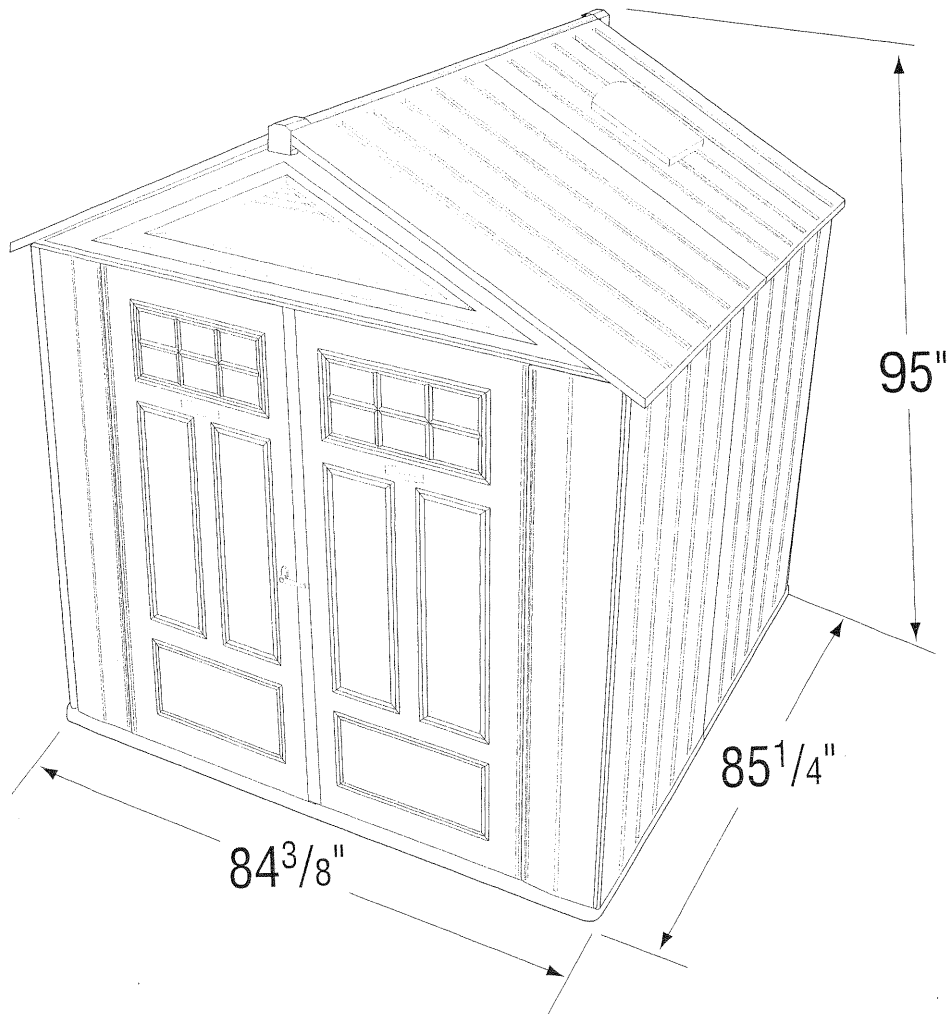
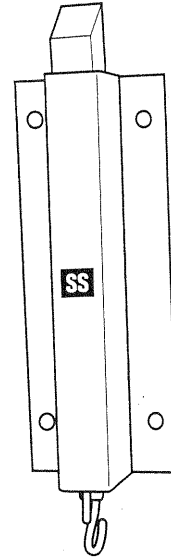
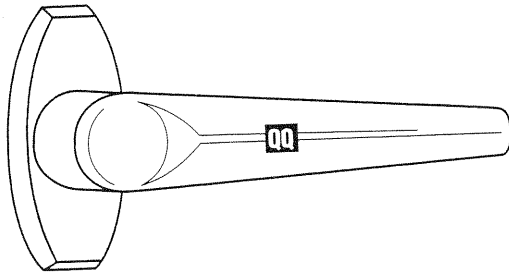

Printed in U.S.A.  
D.R. © 2006 Rubbermaid Home Products,  
Fairlawn, OH, U.S.A. 44333-3306

Customer Service  
Toll Free: 1-888-895-2110  
M-F 8AM to 5PM EST

or visit us at  
[www.rubbermaid.com](http://www.rubbermaid.com)

A **Newell Rubbermaid** Company

L8-3784-P4 ENG