

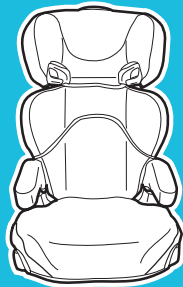

# TURBOBOOSTER

Read This Instruction Manual

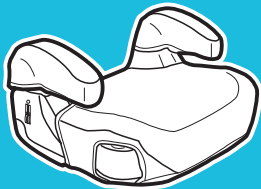

Do not install or use this child restraint until you read and understand the instructions in this manual.

**FAILURE TO PROPERLY USE THIS CHILD RESTRAINT INCREASES THE RISK OF SERIOUS INJURY OR DEATH IN A SUDDEN STOP OR CRASH.**

# 1 Important

*Pages 5-19*

**1-A Quick Guide to Your Manual**

**1-B Welcome to the Graco Family**

**1-C Before You Begin**

Register This Car Seat

If You Need Help

Certification

Car Seat's Useful Life

Vehicle Seat Protection

Warm Weather Use

**1-D Safety Warnings**

# 2 Features

*Pages 20-23*

**2-A Car Seat Features**

## **3 Booster**

*Pages 24-27*

**3-A Booster Use**

**3-B Install Booster**

**3-C Install Backless Booster**

## **4 Securing Child**

*Pages 28-37*

**4-A Securing Child Backed Booster**

**4-B Securing Child Backless Booster**

## **5 Accessories**

*Page 38*

## **6 Vehicle Information**

*Pages 39-42*

**6-A Choosing Vehicle Seat Location**

**6-B Unsafe Vehicle Seat Location**

**6-C Vehicle Seat Belts**

## **7 Care & Cleaning**

*Pages 43*

**7-A Cleaning Seat Pad**

# 1-A Quick Guide to Your Manual

This car seat is for children: **Booster: 40-100 lb (18.1-45 kg) 43-57 in (110.1-145 cm)**

## Car Seat Assembly (On Select Models)

### Adult Assembly Required

#### 1. Armrests

Insert armrest into base as shown until buttons snap into slots on side of base.

Select the desired armrest height for your child, then insert the height adjustment screw and tighten. Repeat for other armrest.

To adjust armrests, remove screw and press in button on side of base as shown to raise or lower. Reinsert screw and tighten. **CHECK** to make sure armrests are securely attached by pulling up on them.

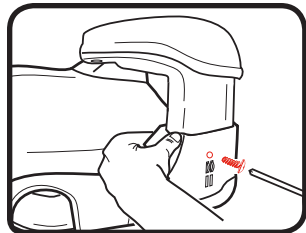
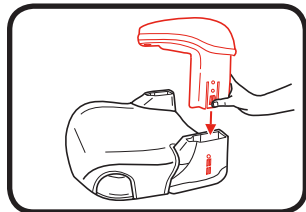
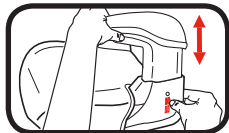



1 Important

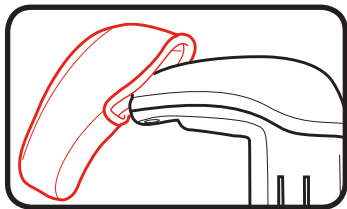

## 2. **Armrest Covers**

Slip armrest covers onto armrests as shown.  
(on certain models)

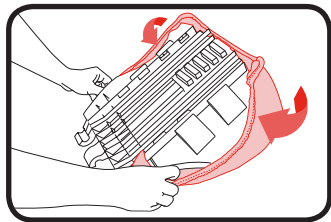

## 3. **Back support pad**

On certain models, your lower back support pad may not be attached to the back support. Place lower back support pad around edges of support as shown. Then fasten lower elastic strap to the metal hook on the other side of the seat pad.

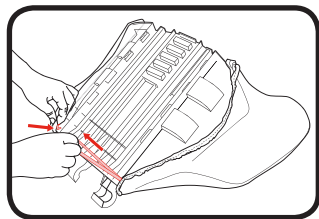

#### 4. **Head support**

Flip head support and lower back support over as shown.

Squeeze red adjustment button and slide two pieces together until they snap into place.

**CHECK** to make sure two pieces are securely snapped together by pulling on them.

Attach elastic strap to metal hook on other side of seat pad as shown.

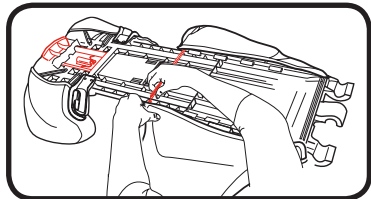
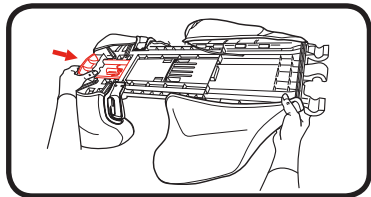
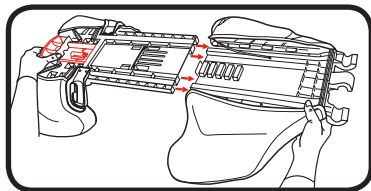

**i** Important



1 Important

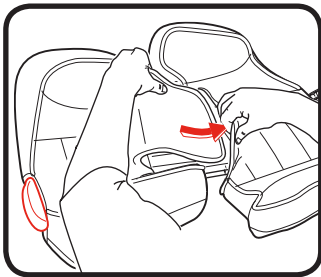

### 5. **Head support pad**

Flip seat over and insert the fabric from the head support underneath the fabric on the lower back support as shown.

To make insertion of fabric easier, slide the upper and lower back pieces apart by squeezing the red adjustment button.

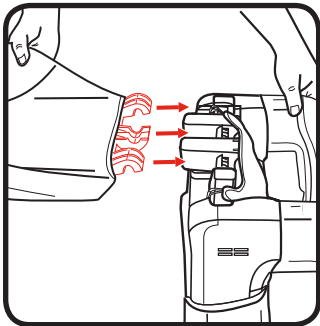

### 6. **Backrest**

Attach backrest to base. “U”-shaped hooks on bottom of backrest will interlock with bars on base.

Make sure that no part of the seat covering interferes when attaching backrest to the base.



Once backrest is securely attached to the base, push backrest up as shown.

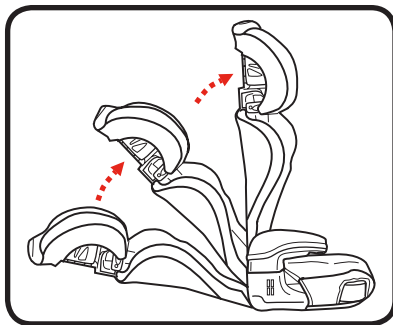

Your Graco booster seat is now ready to use.



**i** Important



1 Important

## ***Get to Know Your Car Seat***

Review section 2-A to see all of the features of this booster seat.

## ***What Seating Location Should I Use?***

***The best seating location for this booster seat is one that:***

- Is recommended by your vehicle owner's manual, and
- Results in a secure installation of this booster seat.

Some vehicles have specific requirements for where the booster seat can be installed, so be sure to check your vehicle owner's manual for available seating positions, if any. For example, sometimes the center rear seat has a lap belt only vehicle seat belt, which cannot be used with this booster seat.

Review section 6-B, 6-C, of this manual AND your vehicle owner's manual.

**According to accident statistics, the safest place for your child in any vehicle is the back seat. The center of the back seat can be the safest during a possible side impact.**



## Using The Car Seat Correctly

To make sure your child is secured properly, review section 3 and 4 to fit your child.

### When Installing As a Booster

#### Vehicle Seat Belt

There is one type of vehicle seat belt that can be used: Lap/Shoulder Seat Belt.

Review section 3 of this manual AND your vehicle owner's manual.

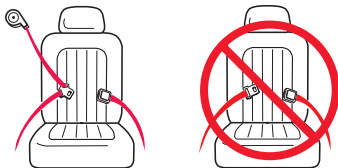

**i** Important

## ***Booster Installation***

### **Use Lap/Shoulder Belt Only**

Review section 3

### **Position Lap Belt**

Lap belt must go under armrest and lie low across your child's hips and thighs.

Review section 3

### **Position Shoulder Belt**

Shoulder belt lies across shoulder between neck and edge of shoulder in the red zone as shown.

Review section 3

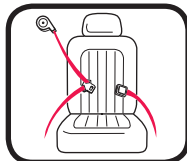

**Highback**



**Backless**

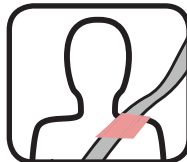

## 1-B Welcome to the Graco Family!

Your child's safety depends on you. No car seat can guarantee protection from injury in every situation, but proper use helps reduce the risk of serious injury or death. Even if this car seat seems easy to figure out on your own, you must follow the detailed instructions in this instruction manual to ensure the steps below are performed correctly.





**1 Important**

## **1-C Before You Begin**

### ***Register This Child Restraint***

Please fill out the prepaid registration postcard attached to the seat pad and mail it in today **or register online at [www.gracobaby.com/carseatregistration](http://www.gracobaby.com/carseatregistration).**

Child restraints could be recalled for safety reasons. You must register this restraint to be reached in a recall. Send your name, address, and the restraint's model number and manufacturing date to:

Graco Children's Products, Inc.  
Attn: Customer Service  
P.O. Box 169, Elverson, PA 19520-9901

**or register online at [www.gracobaby.com/carseatregistration](http://www.gracobaby.com/carseatregistration)  
or call 1-800-345-4109**

For recall information, call the U.S. Government's Vehicle Safety Hotline at 1-888-327-4236 (TTY: 1-800-424-9153), or go to <http://www.NHTSA.gov>.

For future reference or if you change addresses, record the model name, model number, date of manufacture and purchase date of this car seat on the below. You can find this information either on the registration card if you still have it or on the date label located on the back of the car seat.

<b>Model Name</b>	_____
<b>Model Number</b>	_____
<b>Date of Manufacture</b>	_____
<b>Date of Purchase</b>	_____



### ***If You Need Help***

In the U.S.A, please contact our Customer Service Department with any questions you may have concerning parts, use, or maintenance. When you contact us, please have your product's model number and date of manufacture ready so that we may help you efficiently. These numbers can be found on a sticker on the back side of your car seat.

For additional resources or to get your car seat checked by a child passenger safety technician, please visit the following web sites:

[www.nhtsa.gov](http://www.nhtsa.gov) • [www.seatcheck.org](http://www.seatcheck.org) • [www.safekids.org](http://www.safekids.org)



1 Important

### ***Certification***

This child restraint meets or exceeds all applicable requirements of Federal motor vehicle safety standard 213 for use in motor vehicles.



This child restraint is NOT certified for aircraft use when used as a booster seat because aircrafts do not have shoulder belts.

### ***Car Seat's Useful Life***

STOP using this car seat and throw it away 10 years after the date of manufacture. Look for date of manufacture label on back of the car seat.

Graco Children's Products Inc. advises against loaning or passing along a car seat unless you know the complete history of the product. We also advise against purchasing a car seat second hand.

### ***Vehicle Seat Protection***

Protect vehicle seat. Use a car seat mat, towel, or thin blanket under and behind car seat.



### ***Warm Weather Use***

Car seat parts can get very hot in the sun or warm weather. **To avoid burns, always check before putting child in car seat.**

## **1-D Safety Warnings**

**No car seat can guarantee protection from injury in every situation, but proper use helps reduce the risk of serious injury or death. **READ THIS MANUAL CAREFULLY.****

### **⚠️ WARNING!**

**Failure to follow these instructions and child restraint's labels can result in child striking the vehicle's interior during a sudden stop or crash.**



**1 Important**

- ! When forward-facing, children should use the built-in harness system for as long as possible until they reach the maximum forward-facing weight or height for their car seat. At that point, children should ride in a belt-positioning booster seat. A booster is no longer needed once the vehicle seat belt fits properly, typically when they reach 4 feet 9 inches (145 cm) tall and are between ages 8-12. Be sure to check your local and state laws, as well as AAP and NHTSA recommendations, for car seat usage.\***
- ! Review your vehicle owner's manual for more information about air bags and car seat use.**
- ! If your vehicle does not have a back seat, review your vehicle owner's manual.**

\*Graco Supports the American Academy of Pediatrics and National Highway Traffic Safety Administration's Car Seat Guidelines. Visit [www.gracobaby.com/en-US/safety-information](http://www.gracobaby.com/en-US/safety-information) for information on car seat usage recommendations.

- ! Select a suitable location for the car seat in your vehicle.**
- ! Always secure car seat with the vehicle seat belt, even when unoccupied. In a crash, an unsecured car seat can injure occupants.**
- ! If car seat is in a crash, it must be replaced. DO NOT use it again! A crash can cause unseen damage and using it again could result in serious injury or death.**
- ! DO NOT use car seat if it is damaged or missing parts.**
- ! DO NOT use accessories or parts other than those provided by Graco except for a thin towel or mat to protect your vehicle seat. Their use could alter the performance of the car seat.**
- ! Never leave child unattended, even when sleeping.**

## 2-A Car Seat Features



2 Features

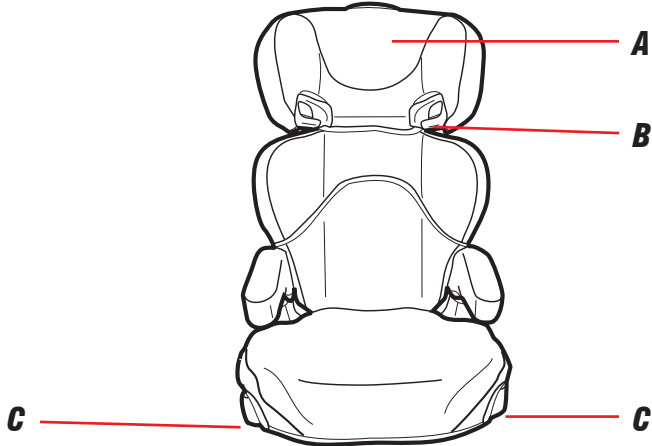

- A** *Head Support*
- B** *Shoulder Belt Guide*
- C** *Cup Holder*



## 2 Features

**A**

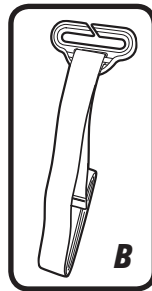
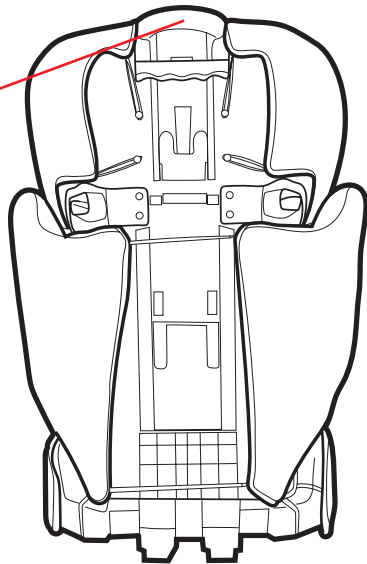

**B**

- A** *Head Support Adjustment Lever*
- B** *Belt Positioning Clip (Inset)*

## 3-A Booster Use

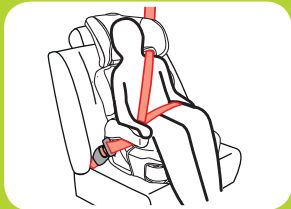

**Vehicle Lap/Shoulder  
Seat Belt**

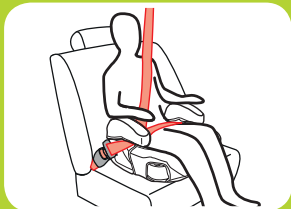

**Vehicle Seat Lap/  
Shoulder Belt**

### **Booster Use With Back:**

**40-100 lb (18.1-45 kg) 43-57 in. (110.1-145 cm)  
at least 4 years old**

**Booster Use Without Back: 40-100 lb (18.1-45 kg)  
43-57 in. (110.1-145 cm) at least 4 years old**

- Place car seat forward-facing in the vehicle back seat.
- Make sure vehicle seat's lap belt is adjusted snugly and lays low on the child's hip and is routed under the armrest in the booster's belt path.
- Vehicle belts **MUST** lie flat against child and **MUST NOT** be twisted.
- Vehicle seat's shoulder belt is adjusted snugly and should lie between child's neck and edge of shoulder.
- **DO NOT** position vehicle shoulder belt under the child's arm or back.



- **Never** use a vehicle lap-only belt across front of child.
- **DO NOT** allow child to slouch or slide down in the booster seat.
- **DO NOT** position vehicle belt over top of armrests.
- Vehicle's seat headrest **SHOULD NOT** create a gap between vehicle seat and booster seat.
- The front of booster seat **MUST NOT** hang over front of vehicle seat.
- If child will not keep vehicle belt properly positioned, **DO NOT** use this booster seat. Use a different car seat.

When forward-facing, children should use the built-in harness system for as long as possible until they reach the maximum forward-facing weight or height for their car seat. At that point, children should ride in a belt-positioning booster seat. A booster is no longer needed once the vehicle seat belt fits properly, typically when they reach 4 feet 9 inches (145 cm) tall and are between ages 8-12. Be sure to check your local and state laws, as well as AAP and NHTSA recommendations, for car seat usage.



**Never Use a Vehicle Lap-Only Belt Across Front of Child**

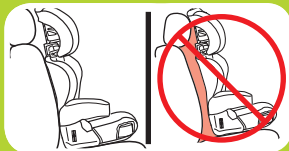

## 3-B Install Booster

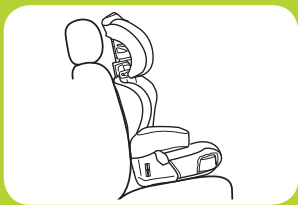

### **1. Place Car Seat Forward-Facing in Back Seat of the Vehicle**

Place forward-facing in vehicle seat. The bottom of the seat should sit as flat as possible on the vehicle seat.



### **2. Thread the Vehicle Seat Shoulder Belt Through Seat Belt Guide on the Headrest**

See section 4-A to secure your child.

## 3-C Install Backless Booster

### 1. Remove the Back Support (on select models)

Recline seat back then remove from base.

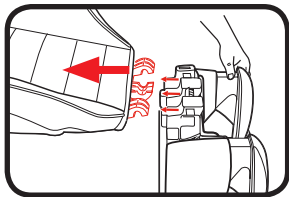

### 2. Place the Booster Seat Forward-Facing in the Back Seat of Vehicle

Place forward-facing on a vehicle seat that has a lap/shoulder seat belt. The base should sit as flat as possible on the vehicle seat.

See section 4-B to secure your child.

27



3 Booster

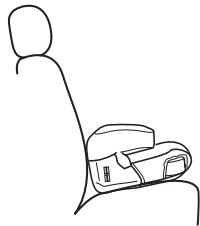
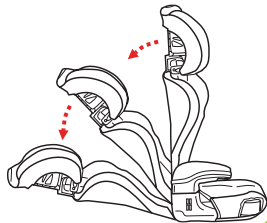

## 4-A Securing Child Backed Booster

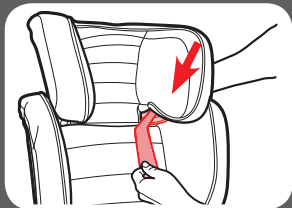

### **!WARNING!**

**Use only the vehicle lap and shoulder belt system when restraining the child in the booster seat.**

#### ***1. Place Child In Seat***

Have your child sit in the booster seat, with his/her back flat against the back of the booster seat.

#### ***2. Thread Vehicle's Shoulder Belt Into Seat Belt Guide in the Headrest***

### 3. To Raise or Lower Headrest Support

Squeeze adjustment lever and lift or lower headrest.

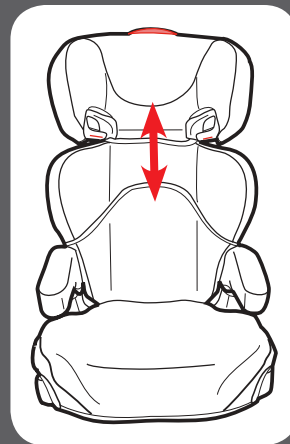
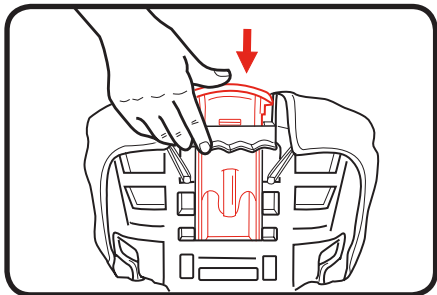

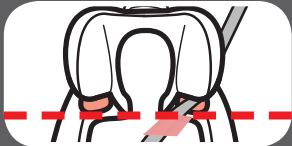
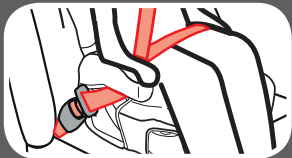

#### **4. Buckle the Vehicle Lap/Shoulder Seat Belt**

Be sure the lap portion of the vehicle seat belt goes under both armrests and the shoulder belt goes under the armrest on the buckle side.

Be sure the lap portion of the vehicle seat belt lies low across your child's hips.

Be sure the shoulder belt lies across your child's shoulders, in the red zone between the neck and edge of shoulder by raising or lowering the head support. The belt guides should be even with or just above the shoulders.

***Is Everything Correct?***

***Never Use Lap Belt Only***

***Lap Belt under Armrest and Lies Low Across Hips and Thighs***

***Shoulder Belt Lies On the Shoulder in the red zone, Between the Neck and Edge of Shoulders***

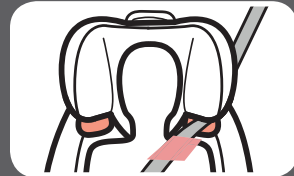
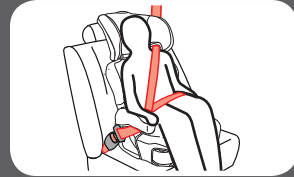

**4 Securing Child**



## 4-B Securing Child Backless Booster

4 Securing Child

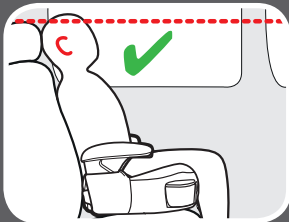

### **!WARNING!**

**Use only the vehicle lap and shoulder belt system when restraining the child in the booster seat.**

#### **1. Place Child In Seat**

Have your child sit in the booster seat, with his/her back flat against the back of the vehicle seat.

#### **2. Ears Must Be Below the Top of the Vehicle Seat Back or Headrest.**



### **3. Buckle the Vehicle Lap/Shoulder Seat Belt**

Be sure the lap portion of the vehicle seat belt goes under both armrests and the shoulder belt goes under the armrest on the buckle side.

Be sure the lap portion of the vehicle seat belt lies low across your child's hips.

Be sure the shoulder belt lies across your child's shoulders, in the red zone between the neck and edge of shoulder.

**You may need to use the belt positioning clip to help get a good fit. See “Using Belt Positioning Clip”**

33

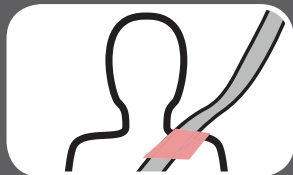

*Is Everything Correct?*

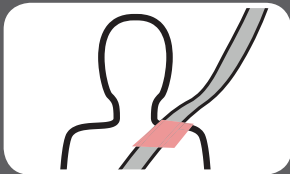
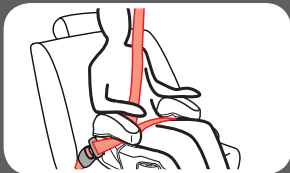

***Never Use Lap Belt Only***

***Lap Belt under Armrest and Lies Low Across Hips and Thighs***

***Shoulder Belt Lies On the Shoulder, in the red zone Between the Neck and Edge of Shoulders***

## Using Belt Positioning Clip

### 1. Make Sure Vehicle's Seat Shoulder Belt Lays in the Red Zone As Shown

If the vehicle's seat shoulder belt lays outside this zone, you **MUST** use the belt positioning clip.

### 2. Attach Belt Positioning Clip

The shoulder belt positioning clip **MUST** be attached to the slot on the bottom of the base.

Insert the loop end of strap through the slot on bottom of seat exactly where shown.

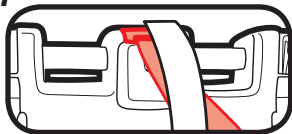

### 3. Push Clip and Strap Through Loop

Pass the clip and the strap through the loop end as shown and pull strap up.

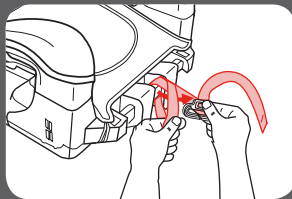
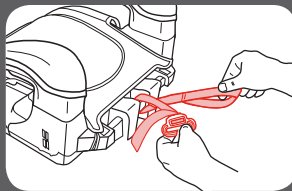
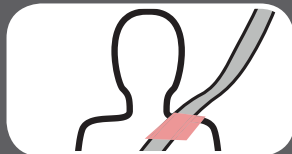

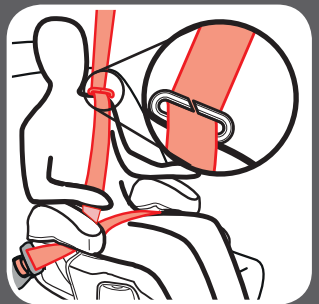
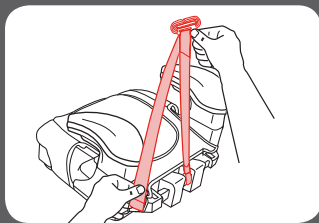

**4. Free End of Strap Should Face Front of Seat**

**5. Place Child in Seat, Buckle Child In Seat and Attach Belt Positioning Clip**

With child's back flat against the back of the vehicle seat, buckle child in. Then slide the clip onto the vehicle's seat shoulder belt as shown.

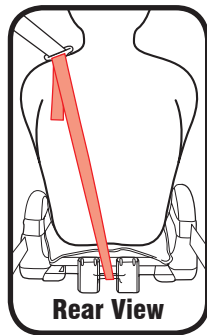

## 6. Adjust the Belt Positioning Clip to Fit Your Child

Lengthen or shorten the belt length as shown.

Clip should fit right at the top of shoulder as shown.

Be sure the lap portion of the vehicle seat belt lies low across your child's hips.

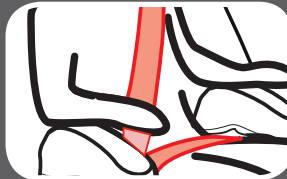
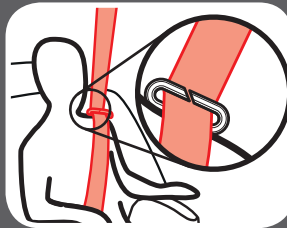
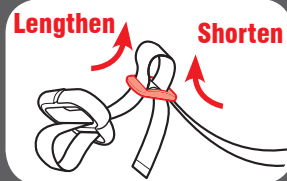

## 5 Accessories *(on select models)*

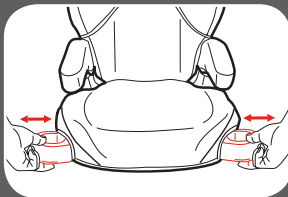

### ***Cup Holders***



### ***Headrest Support and Body Support***

To remove, pull the support out.  
Reinsert as shown.

## 6-A Choosing Vehicle Seat Location

*Review your vehicle's owner manual for Seating Locations*

***The best seating location for this car seat is one that:***

- Is recommended by your vehicle owner's manual, and
- Results in a secure installation of this car seat

In the event there is no available back seat and / or you have no other option, the National Highway Traffic Safety Administration (NHTSA) recommends that you take the following steps:

- Ensure the child is properly restrained according to their age and size
- Move the seat as far back as possible
- Make sure the child is not leaning out of position, such as leaning forward into the deployment path of the air bag
- Set the air bag ON-OFF switch, if available, to the OFF position





## 6-B Unsafe Vehicle Seat Location

Never install this car seat in any of the following vehicle seating locations:



rear-facing or side-facing  
vehicle seats



booster mode with vehicle  
lap belt only seat belt





## 6-C Vehicle Seat Belts

*Review your vehicle's owner manual for vehicle seat belt use*

### *Vehicle Seat Belt Terms*

#### **Retractor**

A device that winds up the unused vehicle seat belt. It is often hidden inside the panels on the walls of the vehicle or in the vehicle seatback.

#### **Latch Plate**

The male end of the seat belt with the silver tongue.

#### **Seat Bight**

The crease where the vehicle seat back and seat bottom meet.

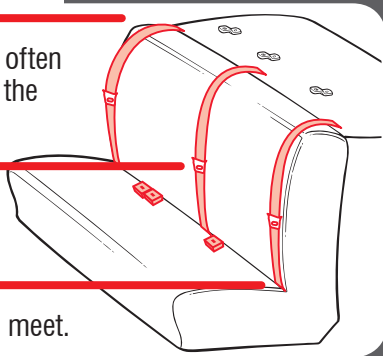



## Identify Your Seat Belt Type

There is one type of vehicle seat belt that can be used with this car seat:

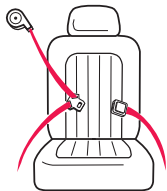

**Lap/Shoulder Belt** 3 connections points. Can be used in all car seats modes of use.



Belts Forward of the Seat Bight:

Some vehicles you may not get a secure fit. Read both your vehicle and car seat manuals.

The following types of vehicle seat belts **CANNOT** be used safely with this car seat:



Lap Belt Only 2 connection points.



Lap Belt with Motorized Shoulder Belt



Lap Belt or Shoulder Belt Mounted on Door

## 7-A Cleaning Seat Pad

Refer to seat pad care tag for washing instructions.

### **To Remove Seat Cover**

Remove elastic loops and hooks from seat as shown.

Clean with a damp sponge using mild soap and cool water. If needed, head support cover may be removed for cleaning.

Machine wash cover in cold water on delicate cycle and drip-dry. **DO NOT USE BLEACH.**

To reattach the seat pad see section 1 and reattach elastic straps as shown.

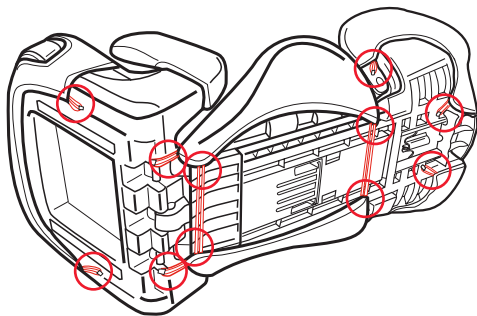

## Replacement Parts

To purchase parts or accessories in the United States,  
please contact us at the following:

**[www.gracobaby.com](http://www.gracobaby.com)**

or

**1-800-345-4109**



Store instruction manual in  
the slot with the instruction  
book icon as shown.

