



FASTACTION™ JOGGER LX

STROLLER AND TRAVEL SYSTEM

Seat Removal

QUICK START GUIDE

This quick start guide is here to help you get started, but please remember to read and understand your instruction manual for full details on how to use your car seat.

NWL0000928713A 1/19



1 REMOVE the canopy.

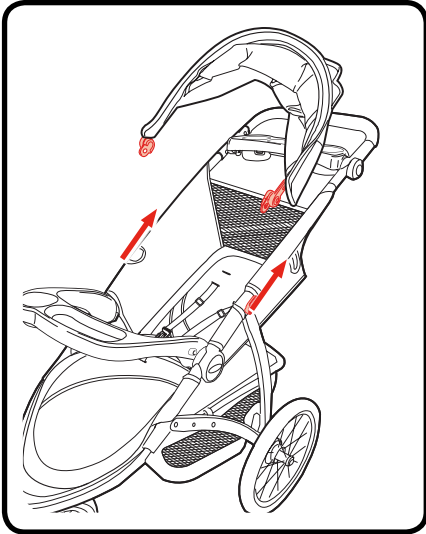

2 From the right side of the stroller, **SEPARATE** the fold strap as shown (A). From the opposite side, pull the fold strap out of the pocket (B).

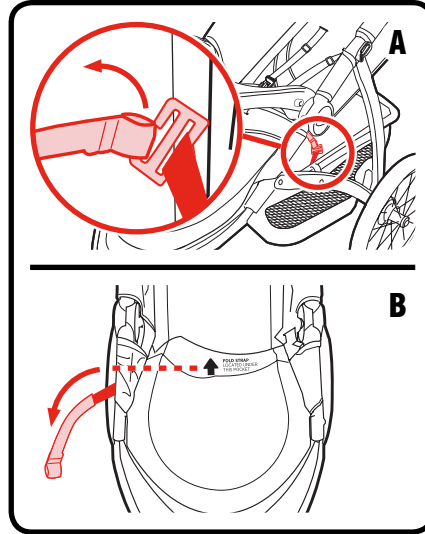

3 **LIFT** up the front of the seat pad, and locate the seat strap. **RELEASE** the hook and loop tape.

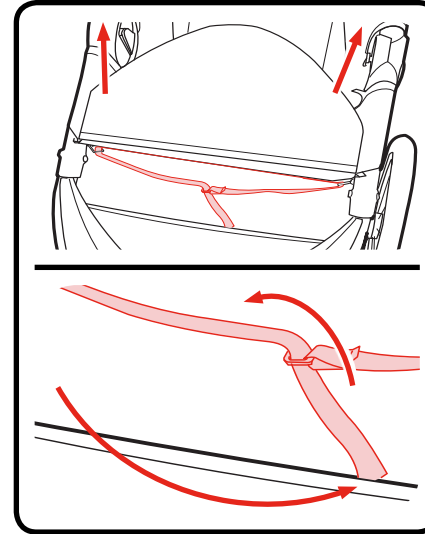

4 UNSNAP the rear seat straps from both sides of the stroller, and **REMOVE** from frame.

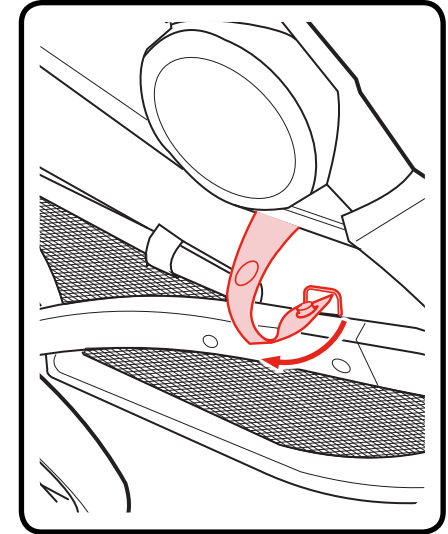

5 UNSNAP the 2 seat back straps.

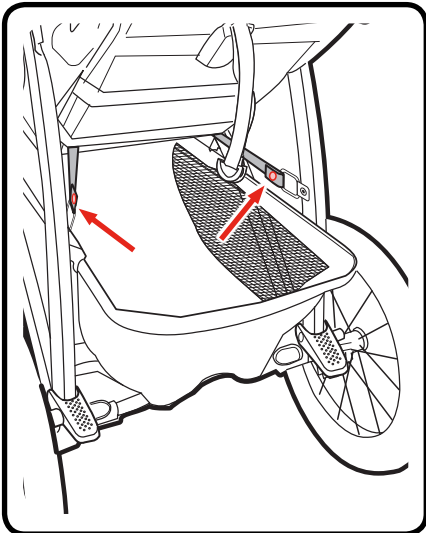

6 UNFASTEN the 12 snaps, and remove the seat from the frame.

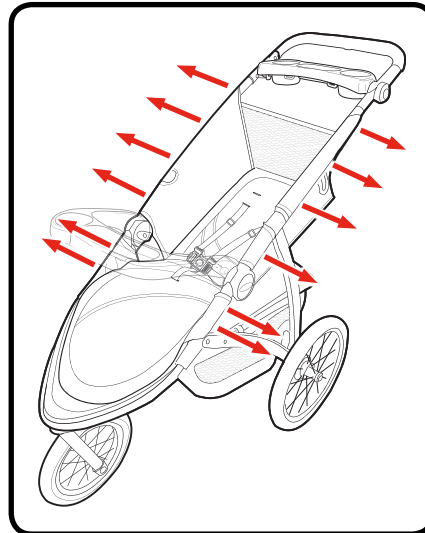

7 RECONNECT the fold strap as shown.

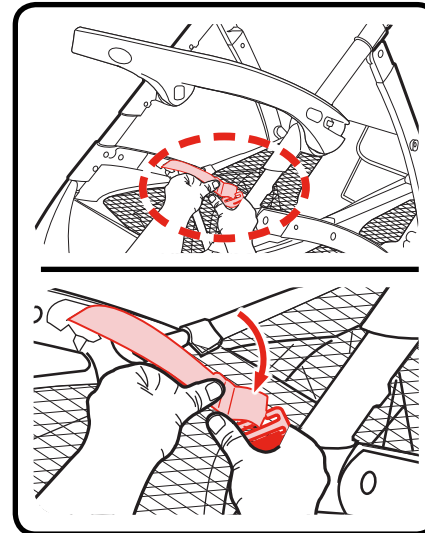

8 INSTALL the canopy (optional).

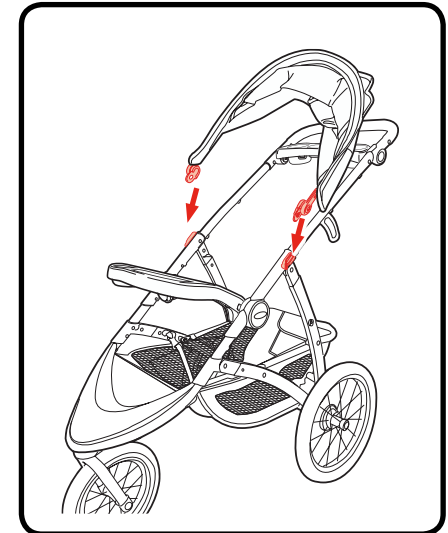

For full details on how to remove the seat pad – see instruction manual pages 21-24
Need more help? VIDEOS AVAILABLE ON GRACOBABY.COM



FASTACTION™ JOGGER LX

STROLLER AND TRAVEL SYSTEM

Seat Attachment

QUICK START GUIDE

This quick start guide is here to help you get started, but please remember to read and understand your instruction manual for full details on how to use your car seat.

NWL0000928713A 1/19



1 REMOVE the canopy.

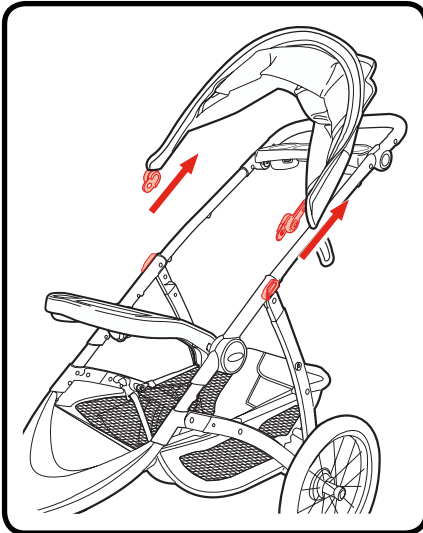

2 SEPARATE the fold strap as shown.

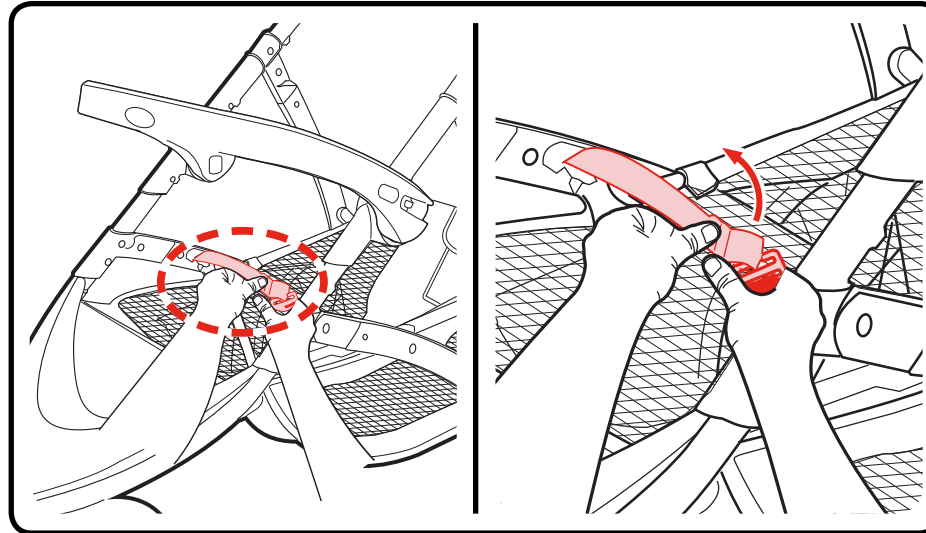

3 LAY the seat in the frame, then **FASTEN** the two rear snaps.

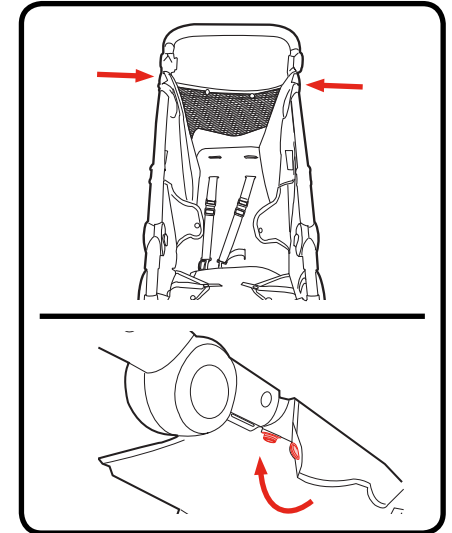

4 INSERT the fold strap into the slot on one side of the seat pad.

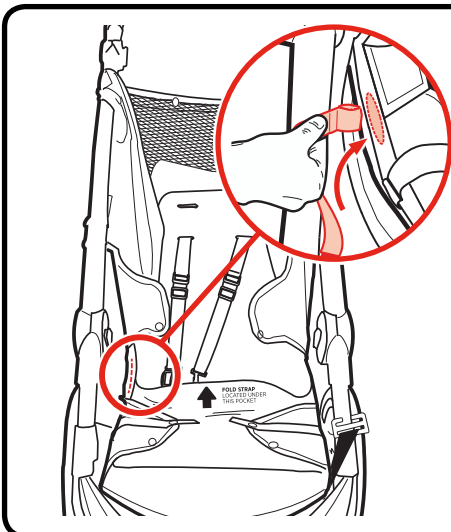

PULL across and out the other slot on the opposite side.

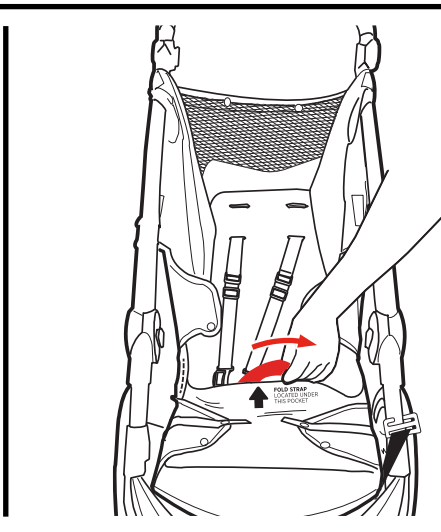

HOOK the straps together as shown.

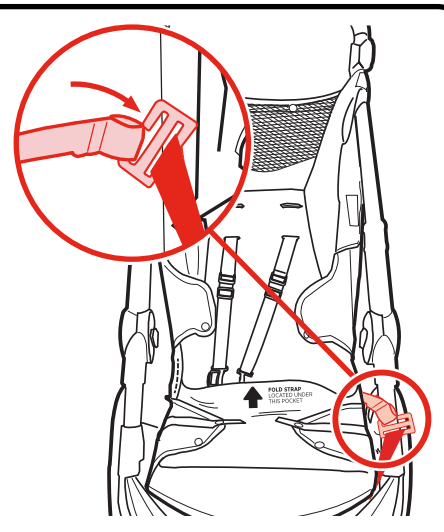

5 LIFT seat pad, then **THREAD** the ends of front seat straps through the loops and pull tight. **FASTEN** the hook and loop tape.

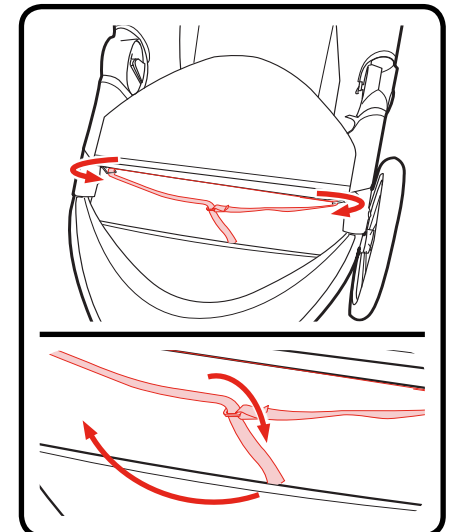

For full details on how to attach the seat pad – see instruction manual pages 25-28
Need more help? VIDEOS AVAILABLE ON GRACOBABY.COM



FASTACTION™ JOGGER LX

STROLLER AND TRAVEL SYSTEM

Seat Attachment

QUICK START GUIDE

This quick start guide is here to help you get started, but please remember to read and understand your instruction manual for full details on how to use your car seat.

NWL0000928713A 1/19



6 **FASTEN** the rest of the snaps to the frame. You **MUST** wrap the seat pad over the frame tubes.

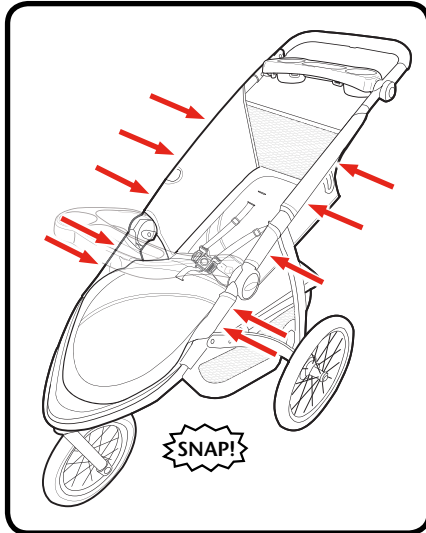

7 **INSERT** and **FASTEN** the rear seat straps through the loops on each side as shown.

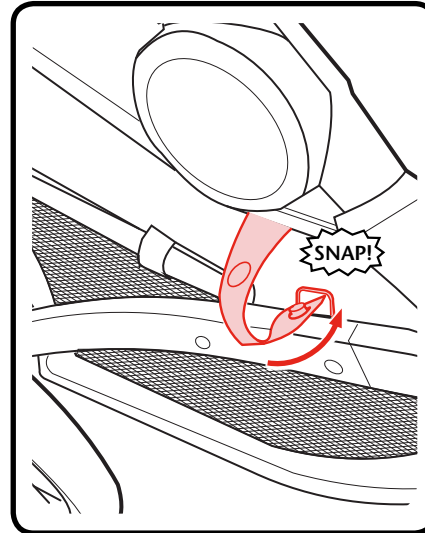

8 **INSERT** the 2 seat back straps through the metal rings, and snap together.

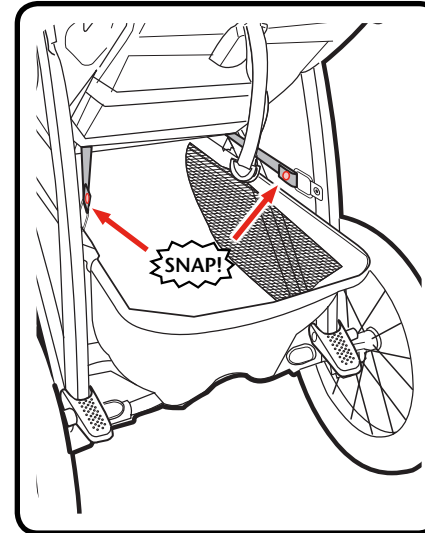

9 **INSTALL** the canopy (optional).

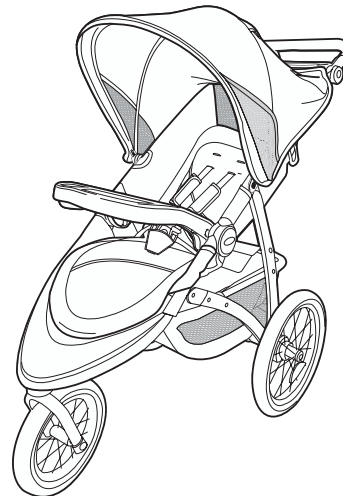
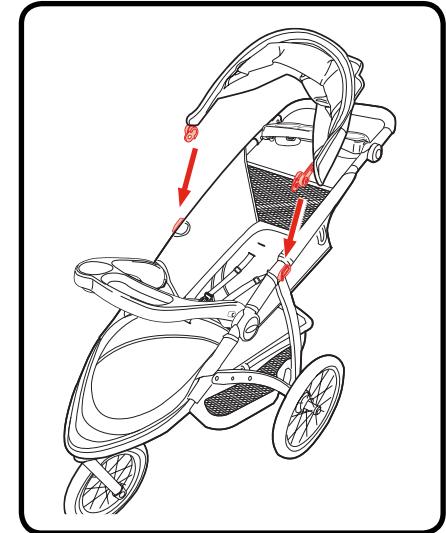

For full details on how to attach the seat pad – see instruction manual pages 25-28
Need more help? VIDEOS AVAILABLE ON GRACOBABY.COM