



www.gracobaby.com

NAUTILUS[®] SNUGLOCK[™] LX/DLX

CHILD RESTRAINT/BOOSTER SEAT

Read This Instruction Manual

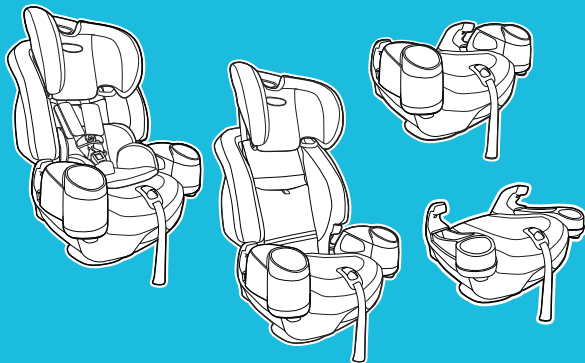

NWL0000701458B 2/18

**Do not install or use
this child restraint until
you read and understand
the instructions in this
manual.**

**FAILURE TO PROPERLY
USE THIS CHILD
RESTRAINT INCREASES
THE RISK OF SERIOUS
INJURY OR DEATH IN A
SUDDEN STOP OR CRASH.**

1 Important

Pages 6-25

1-A Quick Guide to Your Manual

1-B Welcome to the Graco Family

1-C Height and Weight Guidelines

1-D Before You Begin

Register This Car Seat

If You Need Help

Certification

Car Seat's Useful Life

Vehicle Seat Protection

Warm Weather Use

1-E Safety Warnings

2 Features

Pages 26-31

3 Forward-Facing

Pages 32-55

3-A Forward-Facing Use

3-B Install Forward-Facing with InRight™ LATCH Straps

3-C Install Forward-Facing with the Vehicle Seat Belt

4 Booster

Pages 56-72

4-A Booster Use

4-B Install Backed Booster

4-C Install Backless Booster

5 Securing Child

Pages 73-88

5-A Securing Child 5-Point Harness

5-B Securing Child Backed Booster

5-C Securing Child Backless Booster

6 Accessories

Page 89

7 Vehicle Information

Pages 90-100

- 7-A How to Remove InRight™ LATCH and Top Tether**
- 7-B Choosing Vehicle Seat Location**
- 7-C Unsafe Vehicle Seat Location**
- 7-D Vehicle Seat Belts**

8 Care & Cleaning

Pages 101-115

- 8-A Cleaning Seat Pad**
- 8-B Cleaning Rapid Remove™ Cover**
- 8-C Cleaning Buckle Strap**
- 8-D Cleaning Harness and InRight™ LATCH Straps**
- 8-E Cleaning Removable Cup Holders**



1 Important

1-A Quick Guide to Your Manual

This car seat is for children:

- Forward-Facing with 5-Point Harness: 22-65 lb (10-30 kg)*
- High Back Booster: 40-100 lb (18.1-45 kg)*
- Backless Booster: 40-100 lb (18.1-45 kg)*
- Backless Armless Booster: 40-120 lb (18.1-54 kg)*

Car Seat Assembly *(On Select Models)*
(Follow the directions that matches your model)

Adult Assembly Required

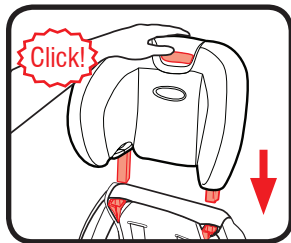

Attach Headrest

Squeeze height adjust button and push headrest into slots on the back support as shown. Headrest will click into the back support.

You may need to unfasten the hook and loop attachment tape on both sides at the top of the back support to allow for easier access to the slots.

Always use child restraint with headrest installed and properly adjusted.

Car Seat Assembly (On Select Models)
(Follow the directions that matches your model)

i 1 Important

Adult Assembly Required

1. Raise Seat Back

Grab seat pad fabric in sitting area to expose the gutters.

Make Sure all hands, fingers and other objects are clear of the gutters.

Make Sure the harness straps are securely attached within the “T”-shaped slots around the arms as shown.

With your other hand, raise seat back so that both arms **LOCK** into the gutters. Arms should **CLICK** into the gutters. Seat assembly should appear as shown.

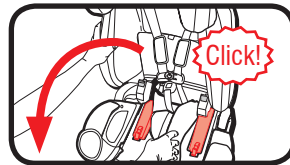
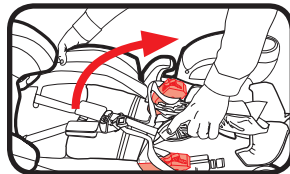
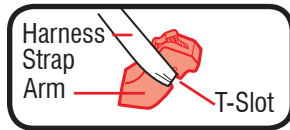
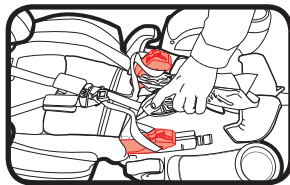

1 Important

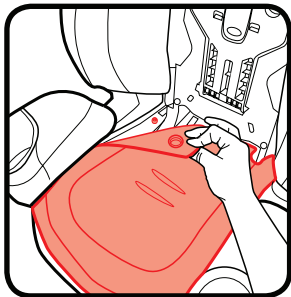

2. Snap On Seat Base Pad to Base

Snap on the base pad as shown. On select models, you may need to attach the 2 elastic loops on the back and side of the seat base.

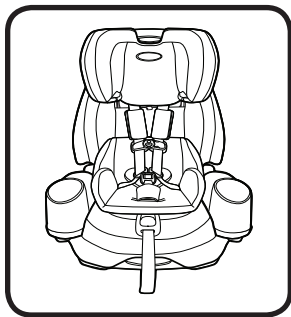

3. Assembly Complete



Get to Know Your Car Seat

Review section 2-A to see all of the features of this car seat.

What Seating Location Should I Use?

The best seating location for this car seat is one that:

- Is recommended by your vehicle owner's manual, and
- Results in a secure installation of this car seat.

Some vehicles have specific requirements for where the car seat can be installed, so be sure to check your vehicle owner's manual for available seating positions, if any. For example, sometimes the center rear seat has a lap belt only vehicle seat belt, which cannot be used when this car seat is in Booster mode.

Review section 7-B, 7-C of this manual AND your vehicle owner's manual.

According to accident statistics, the safest place for your child in any vehicle is the back seat. The center of the back seat can be the safest during a possible side impact.



Which Installation Method Should I Use?

This car seat can be installed in your vehicle using either the vehicle seat belt **OR** the InRight™ LATCH system. Both are equally safe to use. **DO NOT USE BOTH AT THE SAME TIME.**

Vehicle Seat Belt: Review section 7 and your vehicle owner's manual to learn how to install your car seat with the vehicle seat belts.

InRight™ LATCH: The InRight™ LATCH system allows you to securely attach your safety seat in your car without using the vehicle seat belt and possibly to get a better fit. All 2003 and newer model year vehicles are required to have a LATCH system, although some manufacturers began including LATCH earlier. Some vehicle owner manuals use the term ISOFIX to identify the LATCH system.

What is InRight™ LATCH?

i 1 Important

LATCH consists of lower anchors and top tether anchors, which are built-in to your vehicle, and connecting hooks that are built-in to your car seat. Lower anchors are used INSTEAD of the vehicle's seat belt to secure the child seat to the vehicle. Top tethers are used IN ADDITION to the lower anchors OR the vehicle's seat belt to secure a forward-facing car seat to the vehicle.

Review your vehicle's owner manual for exact location and use.

**Vehicle Top Tether
Anchor Points**

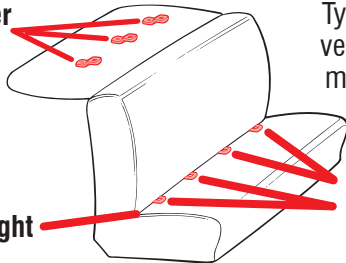

Typical seat in a passenger vehicle. Other vehicle types may have different LATCH locations.

Vehicle Seat Belt

**Vehicle Lower
Anchor Points**



When Installing Forward-Facing

InRight™ LATCH System

LATCH consists of lower anchors, which are built-in to your vehicle, and connecting hooks that are built-in your car seat.

Review section 3-B of this manual AND your vehicle owner's manual.

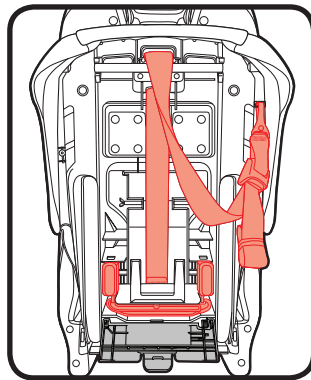
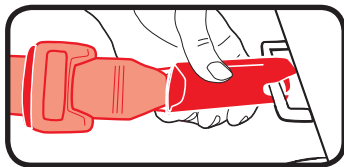

Vehicle Seat Belt

There are two types of vehicle seat belts that can be used. Lap/Shoulder Seat Belt or Lap Only Seat Belt.

Review section 3-C of this manual AND your vehicle owner's manual.

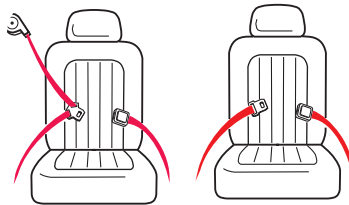

When Installing As a Booster

Vehicle Seat Belt

Only use the Lap/Shoulder seat belt configuration.

Review section 4-B, 4-C of this manual AND your vehicle owner's manual.

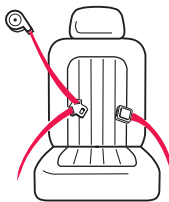

i 1 Important

Does Your Car Seat Fit Your Child Correctly?

To make sure your child is secured properly, review section 3 and 4 to understand all of the actions you need to take to properly adjust the car seat to fit your child.

For Forward-Facing, You Need to Adjust:

Harness Height, Forward-Facing (A)

Harness straps at or just above the child's shoulders and top of child's ears below top of headrest **(B)**. Review section 5.



Buckle Position (C)

The correct slot is the one that is closest to your child without being underneath them. Review section 5.

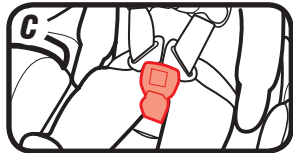

Harness Tightness (D)

If your fingers slide off the harness straps without pinching the straps, it is tight enough. Review section 5.

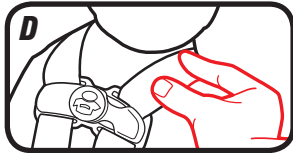

For Booster, You Need to Adjust:

Use Lap/Shoulder Belt Only

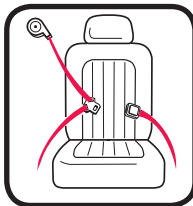

Position Lap Belt

Lap belt must go behind armrest and lie low across your child's hips and thighs.



Position Shoulder Belt

Shoulder belt lies across shoulder between neck and edge of shoulder.

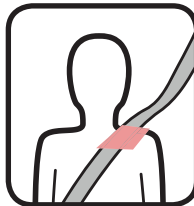
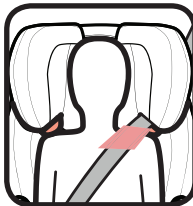

i 1 Important

Forward-Facing Installation

Use the top tether strap when using forward-facing (A)

When used properly, the top tether helps reduce injury in a sudden stop or crash.

Review section 3

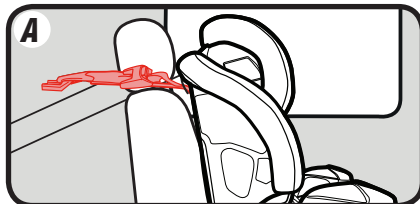

Car Seat Does Not Move More than 1" (2.5 cm) at the Belt Path (B)

Review section 3

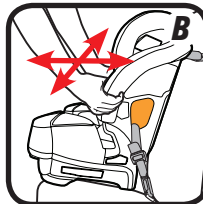

Harness Straps at or Just Above Child's Shoulders (C)

Review section 5

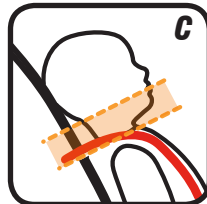

Chest Clip Even With Armpits (D)

Review section 5

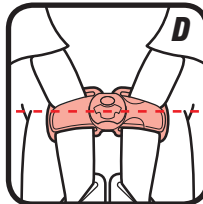

Cannot Pinch Harness Straps at the Shoulder (E)

Review section 5

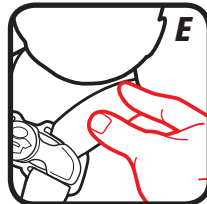

Booster Installation

Never Use Lap Belt Only

Review section 5



Lap Belt Behind Armrest and Lies Low Across Hips and Thighs

Review section 5



Shoulder Belt Lies On the Shoulder, Between the Neck and Edge of Shoulders

Review section 5

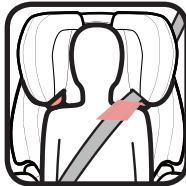

i 1 Important



1 Important

1-B Welcome to the Graco Family!

Your child's safety depends on you. No car seat can guarantee protection from injury in every situation, but proper use helps reduce the risk of serious injury or death.

Even if this car seat seems easy to figure out on your own, you must follow the detailed instructions in this instruction manual to ensure the steps below are performed correctly.

1-C Right Mode of Use

22 lb (10 kg)	40 lb (18.1 kg)	65 lb (30 kg)	100 lb (45 kg)	120 lb (54 kg)
------------------	--------------------	------------------	-------------------	-------------------

Forward-Facing with 5-Point Harness 22-40 lb (10-18 kg) and can sit upright unassisted **MUST** use 5-point harness. 40-65 lb (18-30 kg) **SHOULD** use 5-point harness.

High Back Booster Mode with Vehicle Lap/Shoulder Seat Belt 40-65 lb (18.1-30 kg) **CAN** be in high back booster mode. Over 65 lb (30 kg) **MUST** be in booster mode.

Backless Booster Mode with Vehicle Lap/Shoulder Seat Belt 40-65 lb (18.1-30 kg) **CAN** be in booster mode. Over 65 lb (30 kg) **MUST** be in booster mode.

Backless Armless Booster Mode with Vehicle Lap/Shoulder Seat Belt 40-65 lb (18.1-30 kg) **CAN** be in booster mode. Over 65 lb (30 kg) **MUST** be in booster mode.



1 Important



1 Important

1-D Before You Begin

Register This Child Restraint

Please fill out the prepaid registration postcard attached to the harness and mail it in today **or register online at www.gracobaby.com/carseatregistration**.

Child restraints could be recalled for safety reasons. You must register this restraint to be reached in a recall. Send your name, address, and the restraint's model number and manufacturing date to:

Graco Children's Products, Inc.

Attn: Customer Service

P.O. Box 169, Elverson, PA 19520-9901

or call 1-800-345-4109

or register online at www.gracobaby.com/carseatregistration

For recall information, call the U.S. Government's Vehicle Safety Hotline at 1-888-327-4236 (TTY: 1-800-424-9153), or go to <http://www.NHTSA.gov>

For future reference or if you change addresses, record the model name, model number, date of manufacture and purchase date of this car seat on the below. You can find this information either on the registration card if you still have it or on the date label located on the back of the car seat.

Model Name _____

Model Number _____

Date of Manufacture _____

Date of Purchase _____



1 Important

If You Need Help

In the U.S.A, please contact our Customer Service Department with any questions you may have concerning parts, use, or maintenance. When you contact us, please have your product's model number and date of manufacture ready so that we may help you efficiently. These numbers can be found on a sticker on the back side of your car seat.

For additional resources or to get your car seat checked by a child passenger safety technician, please visit the following web sites:

www.nhtsa.gov • www.seatcheck.org • www.safekids.org



1 Important

Certification

This child restraint meets or exceeds all applicable requirements of Federal motor vehicle safety standard 213 for use in motor vehicles.



This child restraint is certified for use in aircraft only when used with the internal harness system. Use only forward-facing aircraft seats. Follow the instructions for vehicle installation. See section 3-C and 7-D Lap Belt Installation except don't use the top tether.



This child restraint is NOT certified for use in aircraft when used as a booster seat because aircrafts do not have shoulder belts.

Contact the airline for their specific policies.

Car Seat's Useful Life

STOP using this car seat and throw it away 10 years after the date of manufacture. Look for date of manufacture label on back of the car seat.

Graco Children's Products Inc. advises against loaning or passing along a car seat unless you know the complete history of the product. We also advise against purchasing a car seat second hand.

Vehicle Seat Protection

Protect vehicle seat. Use a car seat mat, towel, or thin blanket under and behind car seat.

Warm Weather Use

Car seat parts can get very hot in the sun or warm weather. **To avoid burns, always check before putting child in car seat.**

1-E Safety Warnings

No car seat can guarantee protection from injury in every situation, but proper use helps reduce the risk of serious injury or death. **READ THIS MANUAL CAREFULLY.**

⚠️ WARNING!

Failure to follow these instructions and child restraint's labels can result in child striking the vehicle's interior during a sudden stop or crash.



1 Important

- ! Review your vehicle owner's manual for more information about air bags and car seat use.**
- ! If your vehicle does not have a back seat, review your vehicle owner's manual.**
- ! Select a suitable location for the car seat in your vehicle.**
- ! The American Academy of Pediatrics (AAP) recommends that children should use the built-in harness system for as long as possible until they reach the maximum forward-facing weight or height for their car seat, and after reaching the maximum forward-facing weight or height, that children 4 feet 9 inches (145 cm) tall or under should ride in a belt-positioning booster seat. This car seat can remain forward-facing using the built-in harness system for children up to 65 lb (30 kg) or 49" (125 cm).**
- ! Secure car seat with a vehicle seat belt or InRight™ LATCH that is properly routed as shown in this manual.**
- ! Vehicle seat belt system MUST hold car seat securely. Not all vehicle seat belts can be used with a car seat.**
- ! If vehicle seat belt does not hold car seat securely, read "Vehicle Seat Belts" section 7-D and your vehicle owner's manual.**



1 Important

- ! Always secure car seat with InRight™ LATCH or a vehicle seat belt, even when unoccupied. In a crash, an unsecured car seat can injure passengers.**
- ! If car seat is in a crash, it must be replaced. DO NOT use it again! A crash can cause unseen damage and using it again could result in serious injury or death.**
- ! DO NOT use car seat if it is damaged or missing parts.**
- ! DO NOT use accessories or parts other than those provided by Graco. Their use could alter the performance of the car seat.**
- ! DO NOT remove InRight™ LATCH system from car seat. If using vehicle seat belt to secure car seat, InRight™ LATCH connectors must be stored.**
- ! Never leave child unattended, even when sleeping. Child may become tangled in harness straps and suffocate or strangle.**

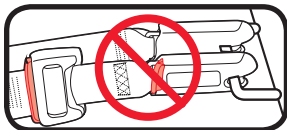

! Never attach two InRight™ LATCH connectors to one vehicle lower anchor point unless specifically allowed by the vehicle manufacturer.

- ! Do not use both the vehicle seat belt and InRight™ LATCH strap at the same time when using the car seat.**

2-A Car Seat Features

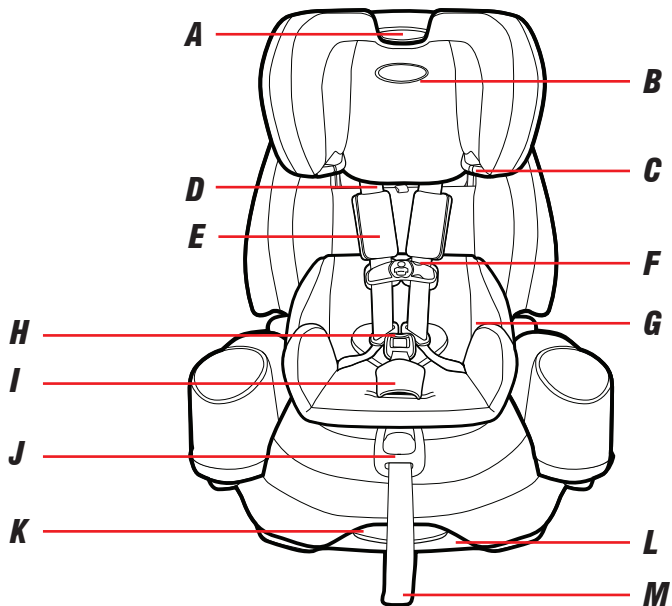

- A Headrest/Harness Adjustment Button**
- B Headrest**
- C Shoulder Belt Guide**
- D Harness Strap**
- E Harness Covers**
- F Chest Clip**
- G Body Support**
(On Select Models)
- H Harness Buckle**
- I Buckle Cover**
(On Select Models)
- J Harness Adjustment Lever**
- K Recline Handle**
- L Recline Foot**
- M Harness Adjustment Strap**
- N Harness Storage Compartment**
(Under Backrest Pad)
- O SnugLock™ Lock-Off**
(Under Backrest Pad)

N
O

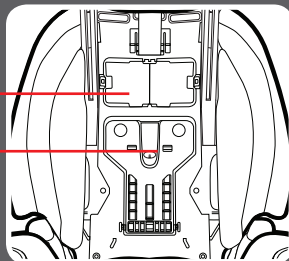

2 Features

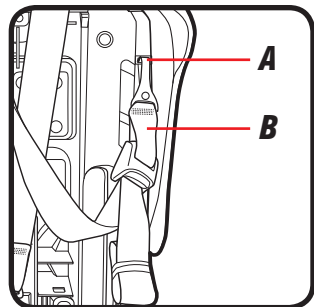
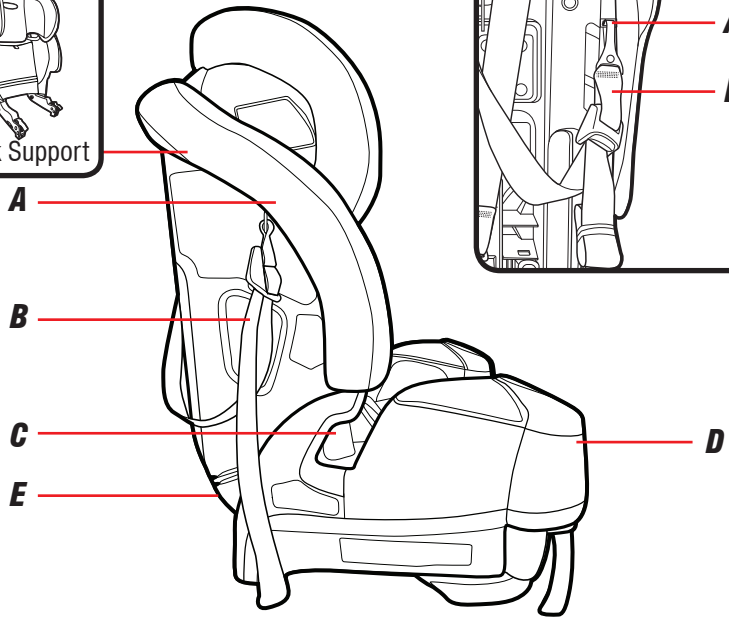

- A Tether Storage Bar**
- B Tether Strap**
- C Booster Belt Guide**
- D Removable Cup Holder**
- E InRight™ LATCH Storage Compartment**



2 Features



2 Features

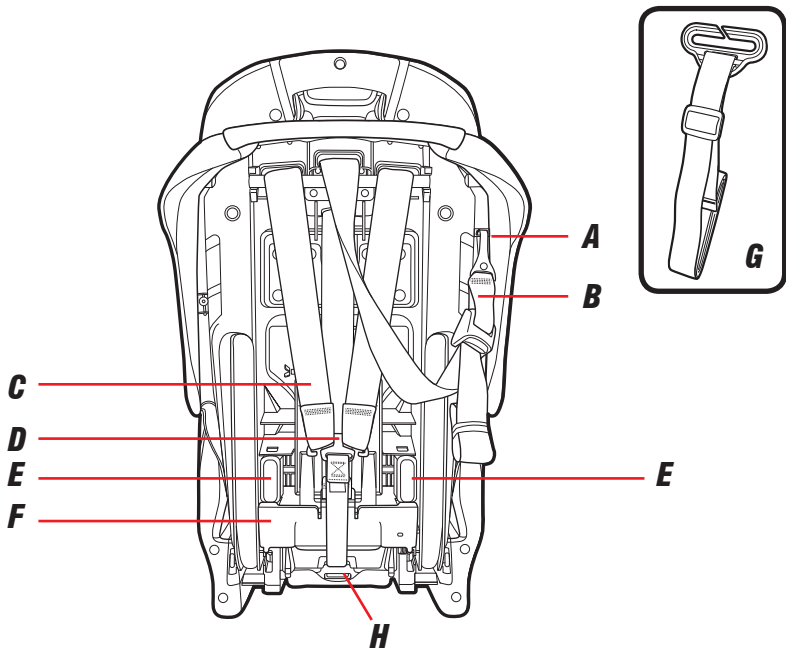

- A Tether Storage Bar**
- B Tether Strap**
- C Harness Straps**
- D Splitter Plate**
- E InRight™ LATCH Connectors**
- F InRight™ LATCH Storage Compartment**
- G Belt Positioning Clip (Inset)***
- H Belt Positioning Clip Attachment Point**
- I InRight™ LATCH Adjuster**
- J InRight™ LATCH Strap**

*Store in Harness Storage Compartment
Until Needed

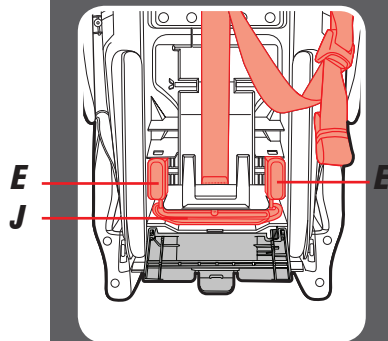
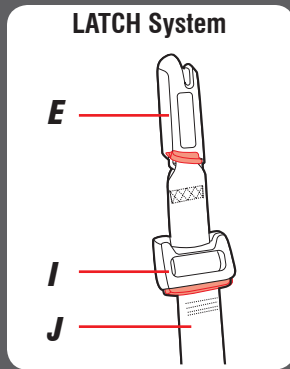

3-A Forward-Facing Use



InRight™ LATCH Strap with Top Tether Strap

*Do not install by this
method for a child
weighing more than
45 lb (20 kg)*

* Check your state laws and AAP/NHTSA recommendations.

***Forward-Facing:
22-65 lb (10-30 kg) and 27-49”
(69-125 cm) at least one year old****

- Place car seat forward-facing in the vehicle back seat.
- Make sure InRight™ LATCH strap or vehicle seat belt is routed through the forward-facing belt path marked with an orange label.
- Attach and tighten top tether strap. When used properly, the top tether helps reduce injury in a sudden stop or crash.
- Install this car seat tightly in your vehicle. Car seat **should not move** at the forward-facing belt path more than 1” (2.5 cm) from side to side, front to back.
- The cup holders must be attached in the forward-facing harnessed mode.

- Harness straps need to be **even with or just above** the top of child's shoulders and chest clip is at **armpit level**.

Visit www.gracobaby.com and the Graco® Nautilus SnugLock™ LX car seat product page to view installation videos.

- * The AAP recommends that children should use the built-in harness system for as long as possible until they reach the maximum forward-facing weight or height for their car seat, and after reaching the maximum forward-facing weight or height, that children 4 feet 9 inches (145 cm) tall or under should ride in a belt-positioning booster seat. This car seat can remain forward-facing using the built-in harness system for children up to 65 lb (30 kg) or 49" (125 cm). Do not install with the InRight™ LATCH system for a child weighing more than 45 lb (20 kg).



Vehicle Lap/Shoulder Belt with Top Tether Strap

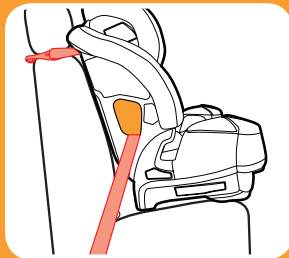

Vehicle Seat Lap Belt with Top Tether Strap

3 Forward Facing

3-B Install Forward-Facing with InRight™ LATCH Straps

Review your vehicle's owner manual for InRight™ LATCH location and use. Installation videos can be found on GracoBaby.com.

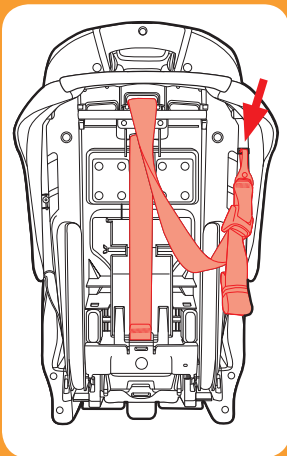

1. Remove InRight™ LATCH Connectors and Top Tether Straps from Storage Locations

Unhook tether and lay it on the seat.

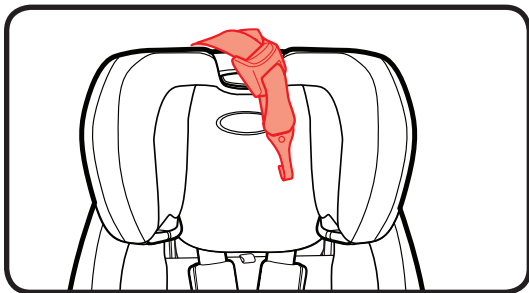

2. Open the InRight™ LATCH Storage Door

3. Take the InRight™ LATCH System Out of the Storage Compartment

Do not remove the InRight™ LATCH system from the car seat.

4. Close the InRight™ LATCH Storage Door

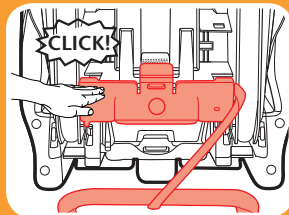
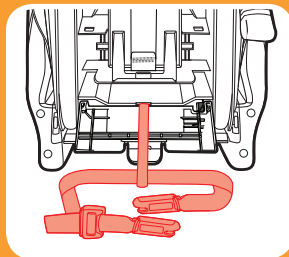
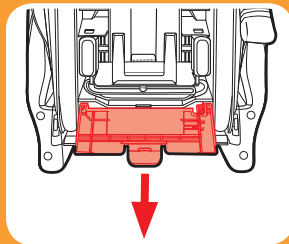

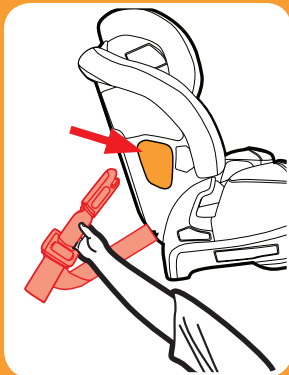

3 Forward Facing

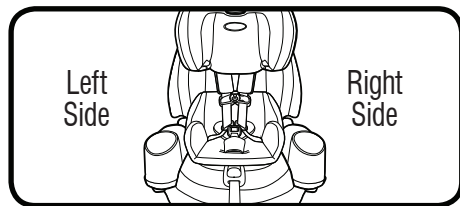

5. Thread the InRight™ LATCH System Into the Forward-Facing Belt Path

From the left side of the seat, thread the InRight™ LATCH connector closest to the adjuster through the forward-facing belt path marked with an orange label as shown.



6. Place Car Seat Forward-Facing in Back Seat of the Vehicle

Place forward-facing in vehicle seat. The bottom of the seat should sit as flat as possible on the vehicle seat.

7. Choose One of the Four Recline Positions

To recline, pull recline handle out and tilt the seat back. For upright position, pull recline handle out and push down on front of seat.

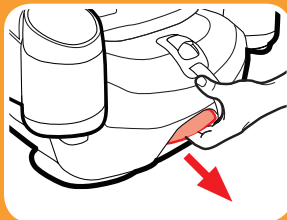

8. Extend the InRight™ LATCH Strap.

For easier installation, extend the InRight™ LATCH strap to its maximum length by pressing the button and pull out on the strap.

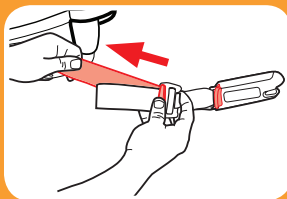

3 Forward Facing

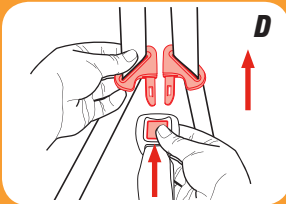
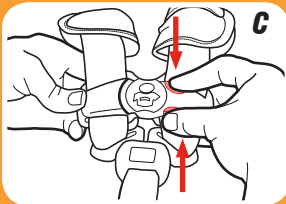
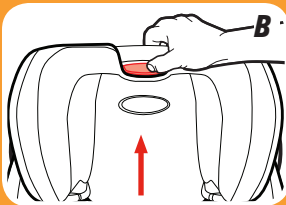

Using With the SnugLock™ Lock-Off:

Skip to step 9-B if not using the SnugLock™ Lock-Off.

9A. Expose the SnugLock™ Lock-Off

- A.** Loosen the harness straps.
- B.** Raise the headrest to the highest position.
- C.** Unbuckle the chest clip.
- D.** Unbuckle the buckle.

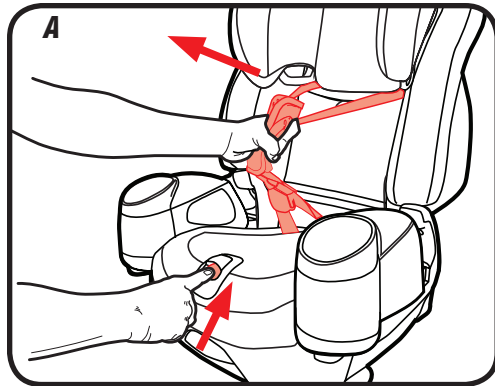

E. Pull down the lower backrest pad to expose the SnugLock™ Lock-Off.

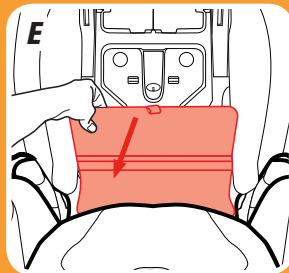

10A. Open the SnugLock™ Lock-Off

Move the InRight™ LATCH strap above the SnugLock™ Lock-Off. Push the bottom of the release, then pull the top of the tab out. Open the SnugLock™ Lock-Off.

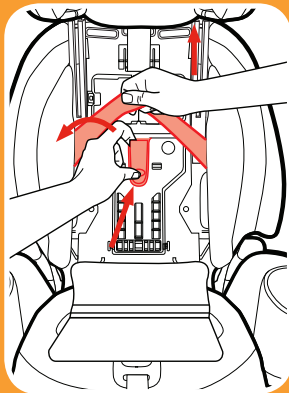

3 Forward Facing

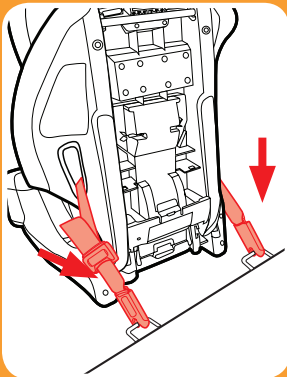
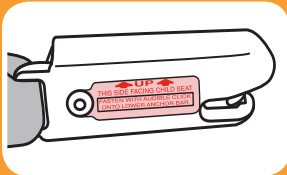
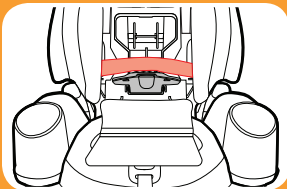

11A. Route the InRight™ LATCH Belt

Place the InRight™ LATCH strap into the SnugLock™ Lock-Off.

12A. Attach InRight™ LATCH Connector to Vehicle's Lower LATCH Anchors

Make sure that the red button faces away from the car seat and the arrows are pointing up. The InRight™ LATCH strap should not be twisted.

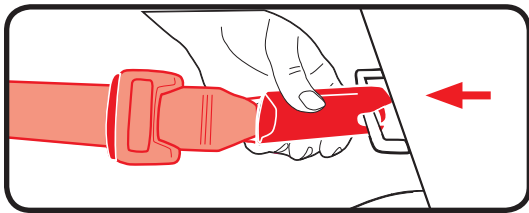

13A. Tighten the InRight™ LATCH Strap

Press down firmly in the top of the base while pulling on the free end of the InRight™ LATCH strap to remove all the slack.

Do not pull on the strap with excessive force.

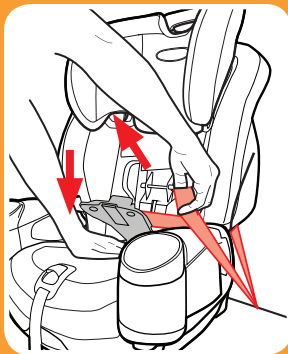

14A. Close and Lock the SnugLock™ Lock-Off

When the slack is removed, close and lock the SnugLock™ Lock-Off. Make sure the InRight™ LATCH strap is under the SnugLock™ Lock-Off.

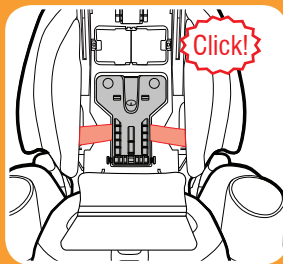

3 Forward Facing

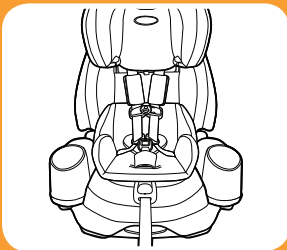

15A. Replace the Lower Backrest Pad

Move the headrest back to its proper position for your child.

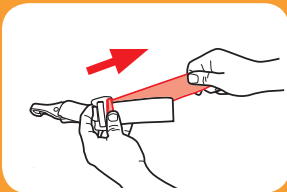

16A. Attach Top Tether Strap

Extend the top tether by pressing the grey button and pulling out on the strap and attach.

Consult vehicle's owner manual for specific location.

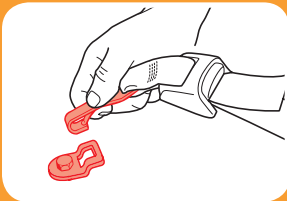

17A. Tighten Top Tether Strap

Remove all the slack.

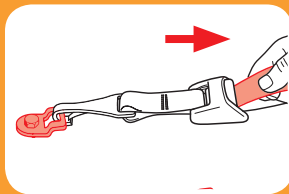

18A. Test For Tightness

Grab the sides of the seat where the InRight™ LATCH strap is and slide the car seat side-to-side and front-to-back.

If the seat moves less than 1" (2.5 cm), it is tight enough.

See section 5-A to secure your child.



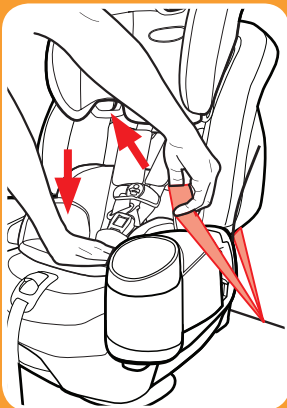
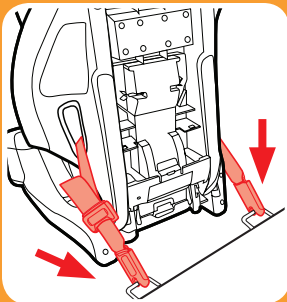

3 Forward Facing



Using Without the SnugLock™ Lock-Off:

9B. Attach InRight™ LATCH Connector to Vehicle's Lower LATCH Anchors.

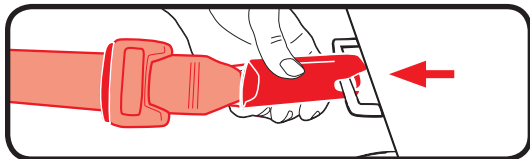
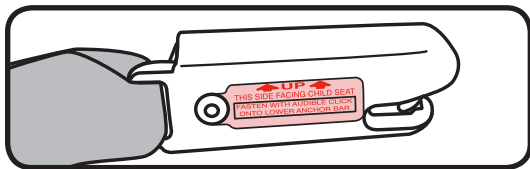
Make sure that the red button faces away from the car seat and the arrows are pointing up. The InRight™ LATCH strap should not be twisted.



10B. Tighten the InRight™ LATCH Strap

Press down firmly in the top of the base while pulling on the free end of the InRight™ LATCH strap to remove all the slack.

Do not pull on the strap with excessive force.

11B. Attach Top Tether Strap

Extend the top tether by pressing the grey button and pulling out on the strap and attach.

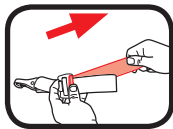

Consult vehicle's owner manual for specific location.

12B. Tighten Top Tether Strap

Remove all the slack.

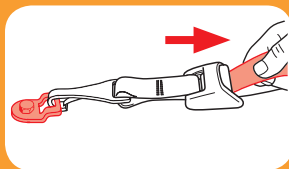
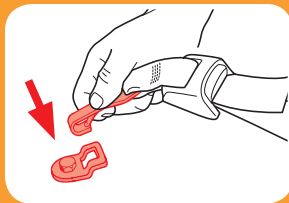

13B. Test For Tightness

Grab the sides of the seat where the InRight™ LATCH strap is and slide the car seat side-to-side and front-to-back.

If the seat moves less than 1" (2.5 cm), it is tight enough.

See section 5-A to secure your child.

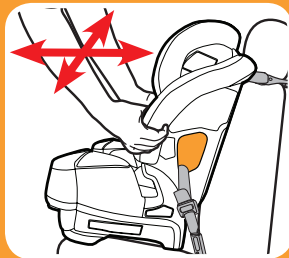

3 Forward Facing

Is Everything Correct?



Car Seat Does Not Move More than 1" (2.5 cm) at the Belt Path



Harness Straps at or Just Above the Child's Shoulders.

Review section 5

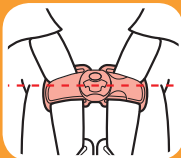

Chest Clip Even With Armpits

Review section 5



Cannot Pinch Harness Straps at the Shoulder

Review section 5

3-C Install Forward-Facing with Vehicle Seat Belt

Installation videos can be found on GracoBaby.com

1. Store InRight™ LATCH System in Storage Compartment

Open storage compartment and store InRight™ LATCH connectors and InRight™ LATCH strap. Close the InRight™ LATCH storage compartment door.

2. Unhook Top Tether Strap From Storage location and Lay It on the Seat

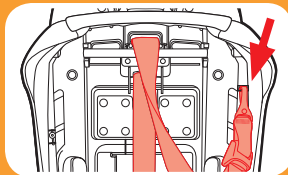
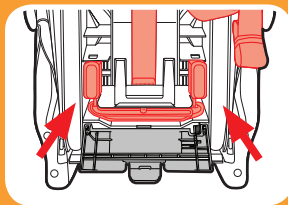

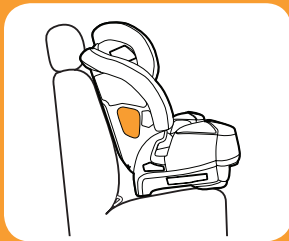

3 Forward Facing

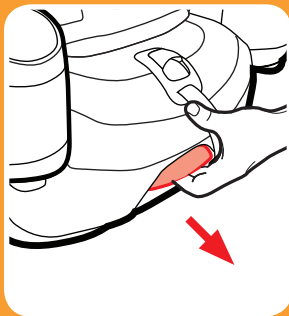

3. Place Car Seat Forward-Facing in Back Seat of the Vehicle

Place forward-facing in vehicle seat. The bottom of the seat should sit as flat as possible on the vehicle seat.



4. Choose One of the Four Recline Positions

To recline, pull recline handle out and tilt the seat back. For upright position, pull recline handle out and push down on front of seat.

Using With the SnugLock™ Lock-Off:

Skip to step 5-B if not using the SnugLock™ Lock-Off.

5A. Expose the SnugLock™ Lock-Off

- A. Loosen the harness straps.
- B. Raise the headrest to the highest position.
- C. Unbuckle the chest clip.
- D. Unbuckle the buckle.

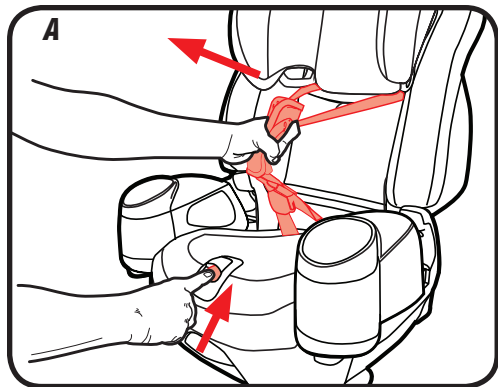

49

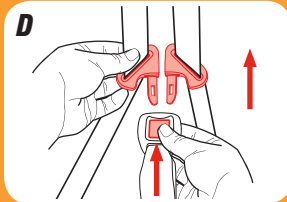
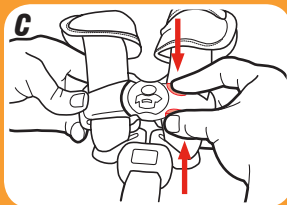
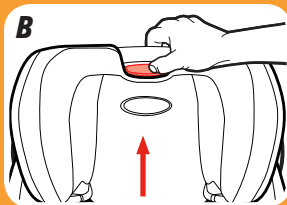

3 Forward
Facing

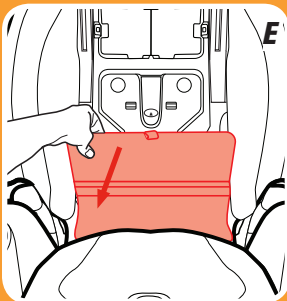

- E.** Pull down the lower backrest pad to expose the SnugLock™ Lock-Off.

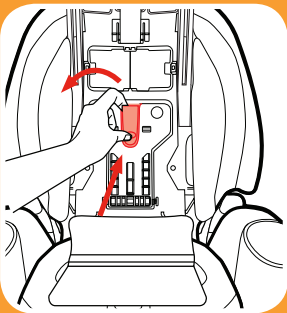

6A. Open the SnugLock™ Lock-Off

Push the bottom of the release, then pull the top of the tab out. Open the SnugLock™ Lock-Off.

7A. Route the Vehicle Seat Belt

Thread vehicle seat belt through the forward-facing belt path (marked with an orange label), through the SnugLock™ Lock-Off, and out the other side. Buckle the seat belt. The seat belt should lie as flat as possible and not be twisted.

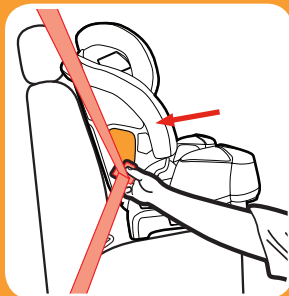
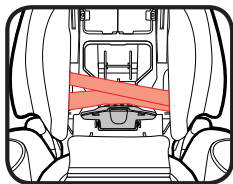

8A. Tighten the Vehicle Seat Belt

Press down firmly on the top of the base while pulling on the shoulder belt to remove the slack.

Do not pull on the strap with excessive force.



3 Forward Facing

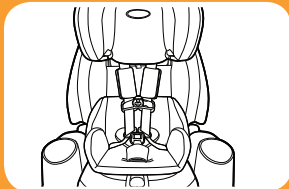
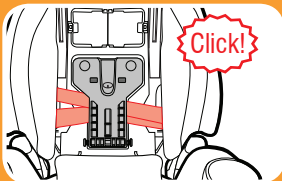

Review your vehicle's owner manual for vehicle seat belt use

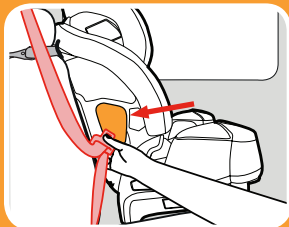

9A. Close and Lock the SnugLock™ Lock-Off

When the slack is removed, close and lock the SnugLock™ Lock-Off. Make sure both lap and shoulder belt are under the SnugLock™ Lock-Off.

10A. Replace the Lower Backrest Pad

Move the headrest back to its proper position for your child.

Using Without the SnugLock™ Lock-Off:

5B. Route the Vehicle Seat Belt

Thread vehicle seat belt through the forward-facing belt path (marked with a orange label) and out the other side. Buckle it. The seat belt should lie as flat as possible and not be twisted.

6B. Lock the Vehicle Seat Belt

In most vehicles today, slowly pull the shoulder belt all the way out and then let it go back in. You will hear a clicking sound. Slowly pull out on the belt and it should be locked. If not, review your car's owner manual and section 7-D.

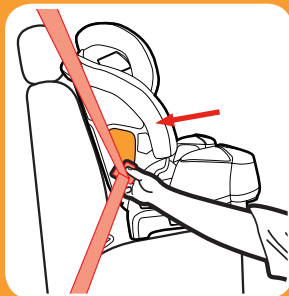

7B. Tighten the Vehicle Seat Belt

Press down firmly on the top of the base while pulling on the shoulder belt to remove the slack.

Do not pull on the strap with excessive force.

After step 7B, continue with step 10 on the next page.



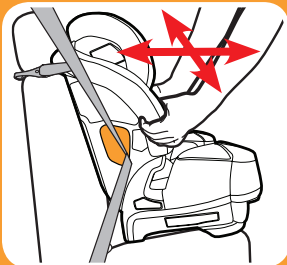
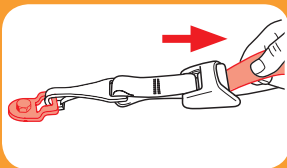
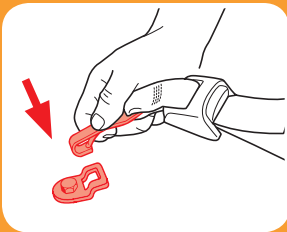

3 Forward Facing

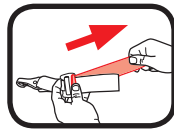

10. Attach Top Tether Strap

Extend the top tether by pressing the grey button and pulling out on the strap and attach.



Consult vehicle's owner manual for specific location.

11. Tighten Top Tether Strap

Remove all the slack.

12. Test For Tightness

Grab the sides of the seat where the vehicle seat belt is and slide the car seat side-to-side and front-to-back.

If the seat moves less than 1" (2.5 cm), it is tight enough.

See section 5-A to secure your child.

Is Everything Correct?

Car Seat Does Not Move More than 1" (2.5 cm) at the Belt Path



Harness Straps at or Just Above the Child's Shoulders.

Review section 5



Chest Clip Even With Armpits

Review section 5

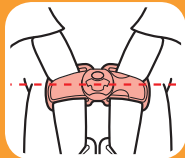

Cannot Pinch Harness Straps at the Shoulder

Review section 5





4-A Booster Use

Vehicle Lap/Shoulder Seat Belt

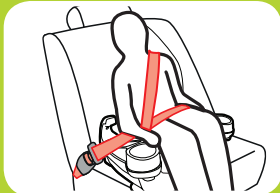
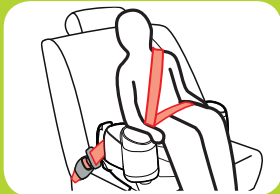
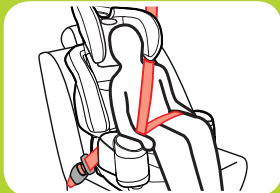

Booster Use With Back: 40-100 lb (18.1-45 kg) 43-57 in. (110.1-145 cm) at least 4 years old*

Booster Use Without Back: 40-100 lb (18.1-45 kg) 43-57 in. (110.1-145 cm) at least 4 years old*

Booster Use Without Back Without Cup Holders: 40-120 lb (18.1-54 kg) 43-57 in. (110.1-145 cm) at least 4 years old*

- Place car seat forward-facing in the vehicle back seat.
- Make sure vehicle seat's lap belt is adjusted snugly and lays low on the child's hip and is routed behind the armrest in the booster's belt path.
- Vehicle belts **MUST** lie flat against child and **MUST NOT** be twisted.
- Vehicle seat's shoulder belt is adjusted snugly and should lie between child's neck and edge of shoulder.
- Booster seat **MUST** be in the most upright position.

- **Never** use a vehicle lap-only belt across front of child.
- **DO NOT** position vehicle shoulder belt under the child's arm or back.
- **DO NOT** allow child to slouch or slide down in the booster seat.
- **DO NOT** position vehicle belt over top of armrests.
- Vehicle's seat headrest **SHOULD NOT** create a gap between vehicle seat and booster seat.
- The front of booster seat **MUST NOT** hang over front of vehicle seat.
- If child will not keep vehicle belt properly positioned, **DO NOT** use this booster seat. Use a different car seat.
- * The AAP recommends that children should use the built-in harness system for as long as possible until they reach the maximum forward-facing weight or height for their car seat, and after reaching the maximum forward-facing weight or height, that children 4 feet 9 inches (145 cm) tall or under should ride in a belt-positioning booster seat. This car seat can remain forward-facing using the built-in harness system for children up to 65 lb (30 kg) or 49" (125 cm).

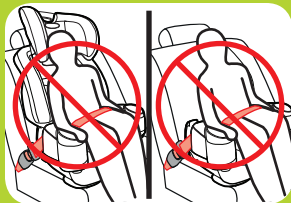

Never Use a Vehicle Lap-Only Belt Across Front of Child

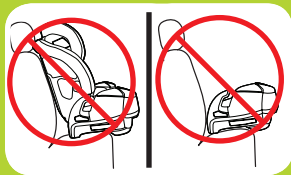
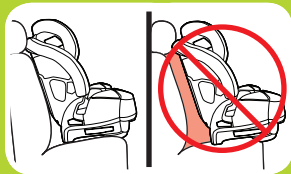

4 Booster



4-B Install Backed Booster

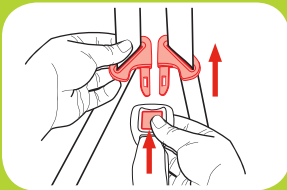
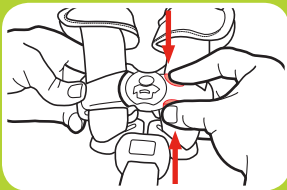
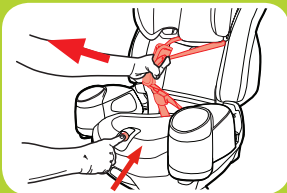

1. Store The Harness System

A. Loosen Harness Straps

Push down on the harness release lever while pulling out on the harness straps.

B. Unbuckle the chest clip

C. Unbuckle the buckle

D. Remove Harness Covers

Store for future use.

E. Remove Lower Backrest Pad

Pull down on the lower backrest pad from the top and unsnap the lower snaps.

Remove the lower portion by unhooking the snaps in the corners of the pad.

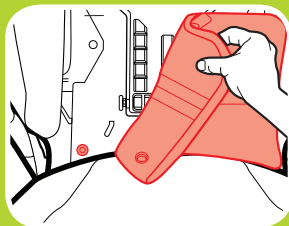
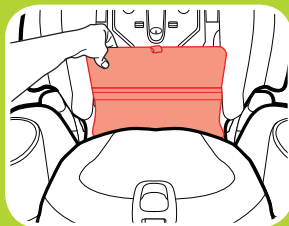
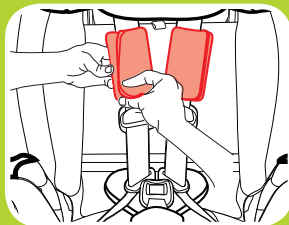

4 Booster

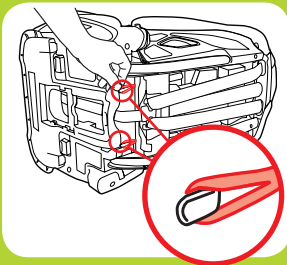
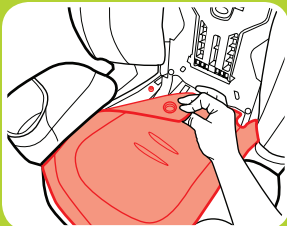

F. Unsnap the Seat Base Pad

Unsnap both sides of the seat base pad. On select models, you will need to detach the two straps on the back of the seat.

G. Store the Buckle

Lift base pad up and pull the buckle through the pad and store the buckle as shown.

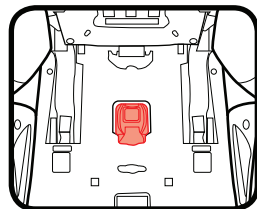

H. Pull Up Upper Backrest Pad to Expose the Harness Storage Location

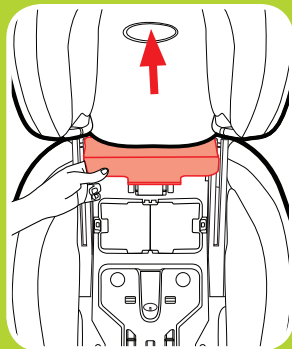

4 Booster

I. Open Storage Doors

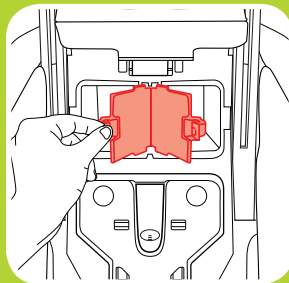



4 Booster

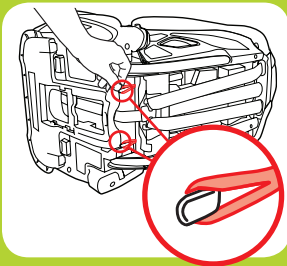
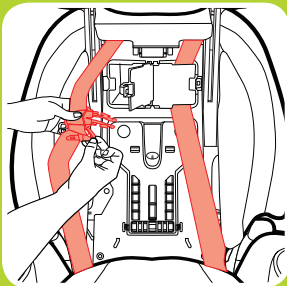

J. Place Harness, Chest Clip and Buckle Tongues Inside Storage Compartment and Close the Door

K. Replace the Seat Pads

Replace both the upper and lower backrest pads. Resnap the seat base pad. On select models, you will need to reattach the 2 elastic straps to the back of the seat.

2. Unhook Top Tether Strap From Storage location and Lay it on the Seat

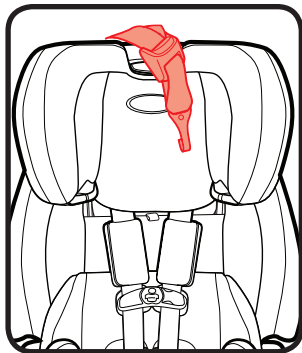

3. Place Booster Seat in the Most Upright Position

Pull the recline handle out and push down on front of seat. Put the booster seat in the most upright position.

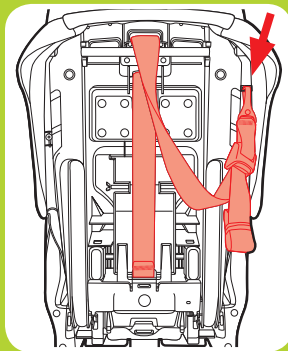

4 Booster

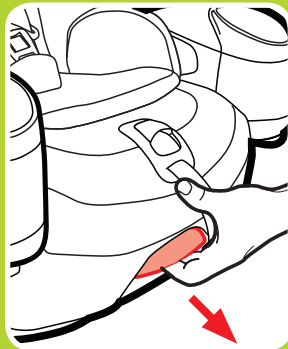



4 Booster

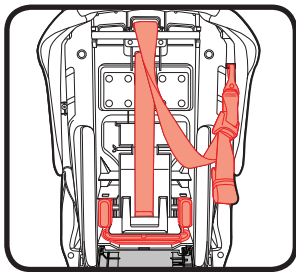

seat belts or if the chosen seating position does not have InRight™ LATCH, you **MUST** store the InRight™ LATCH strap. Store the InRight™ LATCH strap and connectors in storage compartment. Store the top tether strap as shown. Always secure car seat with InRight™ LATCH or a vehicle seat belt, even when unoccupied. In a crash, an unsecured car seat can injure passengers.

Skip to Step 14 if Not Using InRight™ LATCH

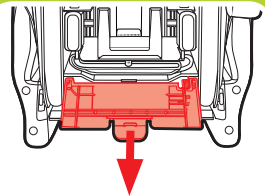

Graco allows the securing of the car seat with InRight™ LATCH in the booster mode. The child still **MUST BE SECURED** with the vehicle lap/shoulder seat belt. InRight™ LATCH can be used in the booster mode regardless of the weight of the child up to 100 lb (45 kg).

Verify the following before using InRight™ LATCH in the booster mode:

- The InRight™ LATCH connectors **DO NOT** interfere with any vehicle seat belts or buckles.

If the InRight™ LATCH interferes with the vehicle

seat belts or if the chosen seating position does not have InRight™ LATCH, you **MUST** store the InRight™ LATCH strap. Store the InRight™ LATCH strap and connectors in storage compartment. Store the top tether strap as shown. Always secure car seat with InRight™ LATCH or a vehicle seat belt, even when unoccupied. In a crash, an unsecured car seat can injure passengers.

4. Open the InRight™ LATCH Storage Door

5. Take the InRight™ LATCH System Out of the Storage Compartment

Do not remove the InRight™ LATCH system from the car seat.

6. Close the InRight™ LATCH Storage Door

7. Thread the InRight™ LATCH System Into the Forward-Facing Belt Path

From the right side of the seat, thread the InRight™ LATCH connector closest to the adjuster through the forward-facing belt path marked with an orange label as shown.

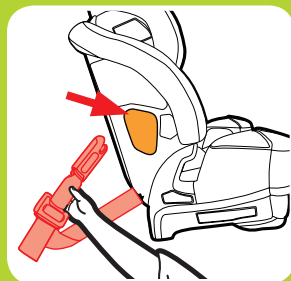
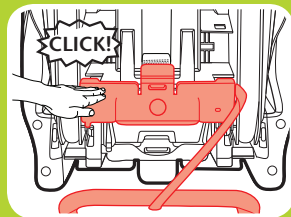
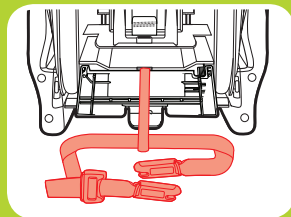

4 Booster



4 Booster

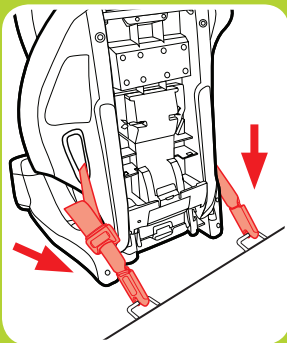
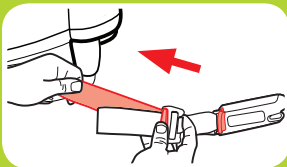

8. Place Car Seat Forward-Facing in Back Seat of the Vehicle

Place forward-facing in vehicle seat. The bottom of the seat should sit as flat as possible on the vehicle seat.

9. Extend the InRight™ LATCH Strap

For easier installation, extend the InRight™ LATCH strap to its maximum length by pressing the grey button and pull out on the strap.

10. Attach InRight™ LATCH Connectors to Vehicle's Lower LATCH Anchors

Make sure that the red button faces away from the car seat and the arrows are pointing up. The InRight™ LATCH strap should not be twisted.

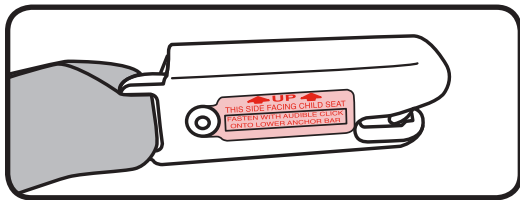

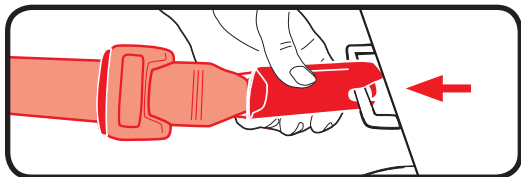

11. Tighten the InRight™ LATCH Strap

Press down firmly in the top of the base while pulling on the free end of the InRight™ LATCH strap to remove all the slack.

Do not pull on the strap with excessive force.

12. Attach Top Tether Strap

Extend the top tether by pressing the grey button and pulling out on the strap and attach.

Consult vehicle's owner manual for specific location.

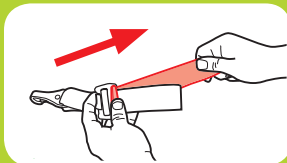
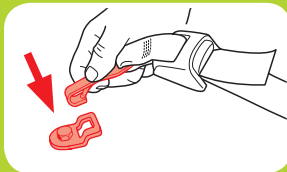
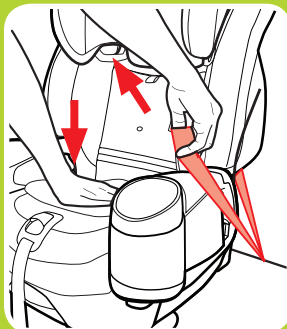

4 Booster



4 Booster

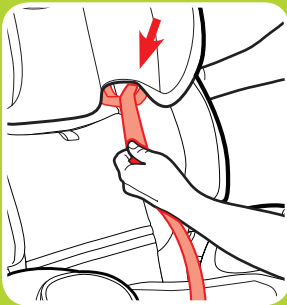
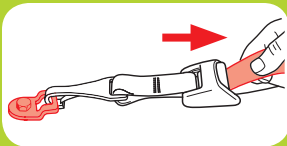

13. Tighten Top Tether Strap

Remove all the slack.

14. Thread the Vehicle Seat Shoulder Belt Through Seat Belt Guide on the Headrest

See section 5-B to secure your child.

4-C Install Backless Booster



4 Booster

1. Remove the Seat Back

A. With the harness system loose, from the back of the seat, remove the harness straps from the splitter plate as shown.

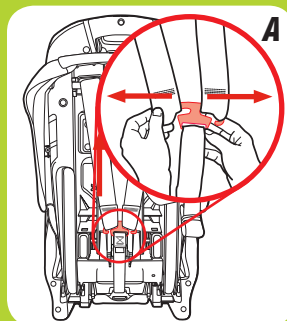

B. Unsnap seat base pad and pull forward to expose the seat base. Undo elastic straps on select models.

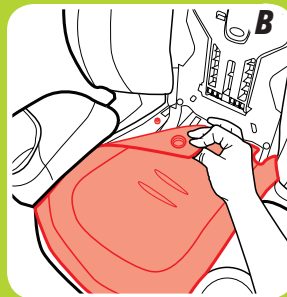
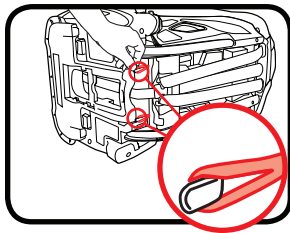



4 Booster

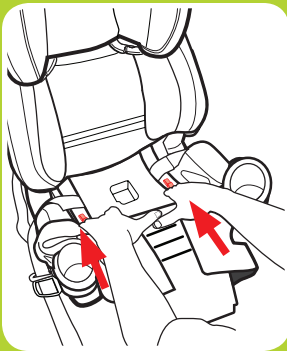
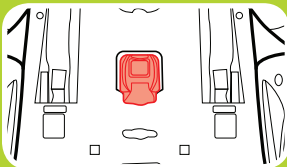
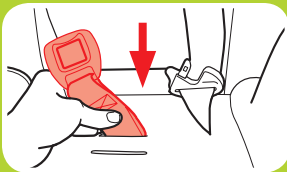

C. Push the buckle through the pad and store.

D. Release the back support by pulling the seat base pad forward to expose the seat base. Slide the 2 buttons towards the seat back and lower the seat back into a flat position.

E. Squeeze the 2 buttons together and slide backrest out of the base.

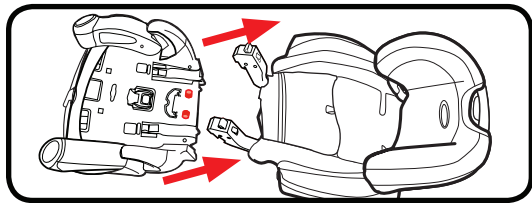

F. Store the splitter plate on the base of the seat.

G. Pull on the adjustment strap on the front of the seat to lock the splitter plate into place.

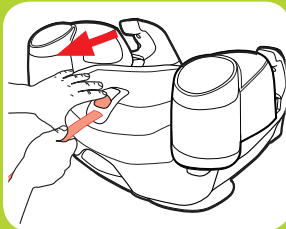
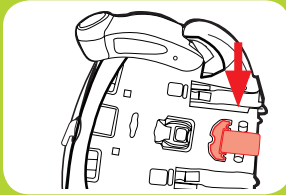
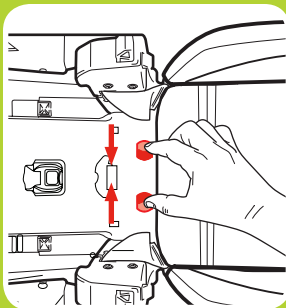

4 Booster



4 Booster

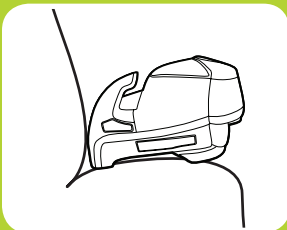
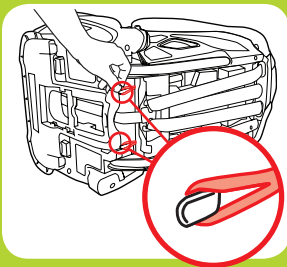
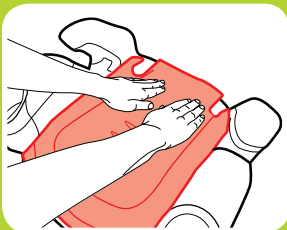

H. Replace the Seat Pads

Resnap the seat base pad. On select models, attach the elastic straps at the back of the seat.

3. Place the Booster Seat Forward-Facing in the Back Seat of Vehicle

Place forward-facing on a vehicle seat that has a lap/shoulder seat belt. Pull recline handle out and push down on front of seat. Put booster seat in the most upright position. The base should sit as flat as possible on the vehicle seat.

See section 5-C to secure your child.

!WARNING!

WARNING! In cold weather, do not put snowsuits or bulky garments on your child when placing them in the car seat. Bulky clothing can prevent the harness straps from being tightened properly. To keep child warm, buckle your child in the car seat and place a blanket around the child or place the child's coat on backwards after buckling in.



5-A Securing Child 5-Point Harness

1. Loosen Harness Straps

(A) Push down on the harness release lever while pulling out on the harness straps at the chest clip.

(B) Unbuckle the chest clip and the buckle strap.

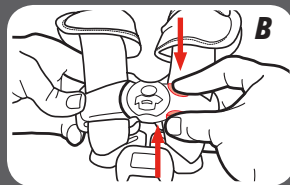
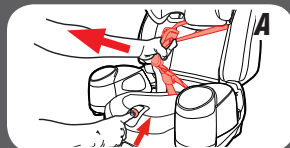

5 Securing Child

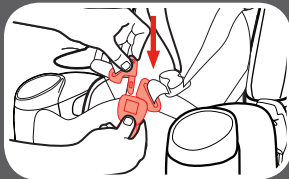
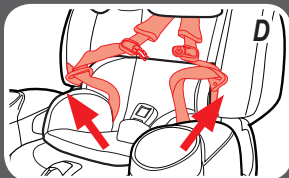
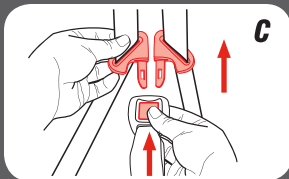

(C) Place harness straps off to the sides.

(D) On select models, place buckle tongues in buckle storage pocket.

2. Place Your Child in the Seat

Make sure their back is flat against the car seat back.

3. Place Harness Straps Over Child's Shoulders and Buckle

You will hear a “click” when buckle tongues are securely attached. Pull up on each buckle tongue to make sure it is securely attached.

4. *Be Sure the Harness Straps Are at the Proper Height*

Forward-Facing: Harness straps must be **at or just above** the child's shoulders and top of child's ears must be **below** top of headrest.

5. *To Raise or Lower Headrest/Harness*

Press the adjustment button and lift or lower headrest for the proper harness height.

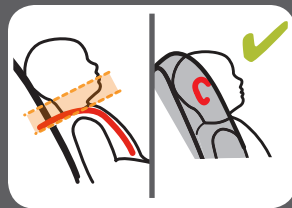
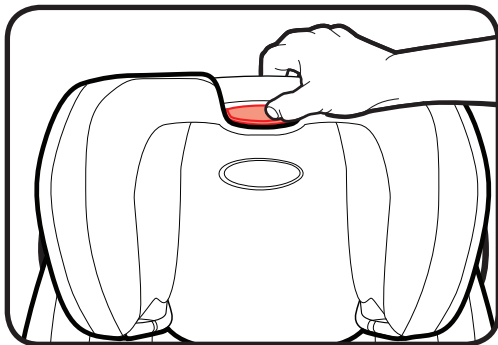

Forward-Facing

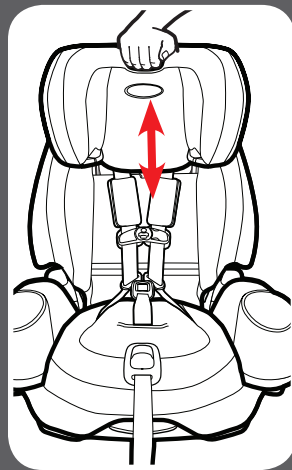

5 Securing
Child



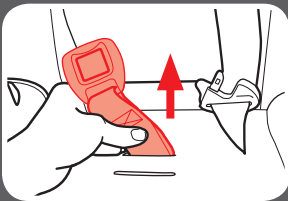
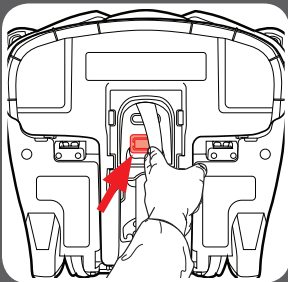
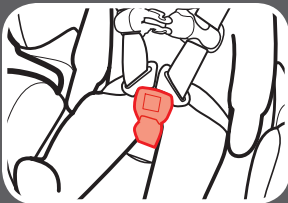

6. Check the Buckle Position

The correct slot the one that is closest to your child without being underneath your child.

7. To Adjust the Buckle Strap

From bottom of car seat, rotate metal retainer to side in order to push it through slot easier.

8. Pull buckle strap from child restraint as shown.

9. Insert Metal Retainer in the New Buckle Strap Slot

Reach underneath the car seat and pull the metal retainer through.

10. Pull Up on Buckle Strap to Make Sure it is Secured

11. Buckle the Chest Clip

You will hear a “click” when the chest clip is securely buckled.

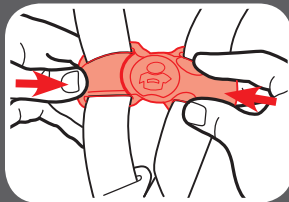
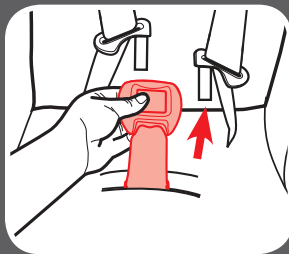
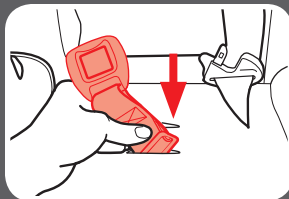

**5 Securing
Child**



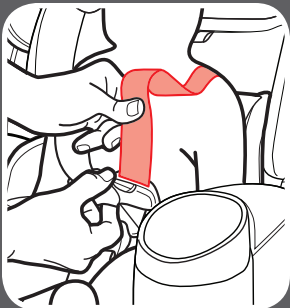

12. Pull All the Slack Out From Around the Waist

Pull up on the harness strap while pushing the chest clip down. Do this to both sides.

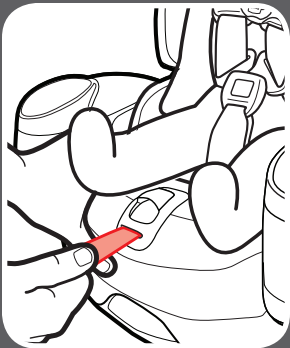

13. Tighten the Harness by Pulling the Harness Adjustment Strap

When you are not able to pinch any of the harness webbing at your child's shoulder, the harness is tight enough.

A snug harness should not allow any slack. It lies in a relatively straight line without sagging. It does not press on the child's flesh or push the child's body into an unnatural position.

14. Raise the Chest Clip to Child's Armpit Level

15. Check Tightness Again, Tighten More if Needed

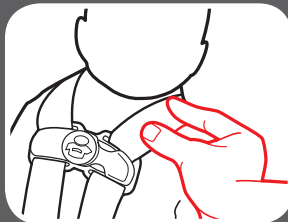
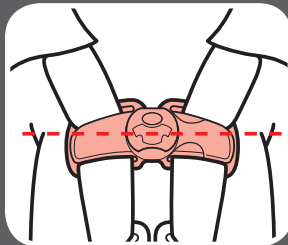
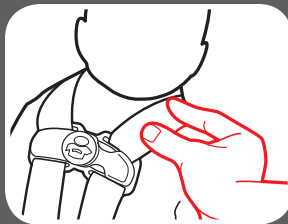

**5 Securing
Child**



5-B Securing Child Backed Booster

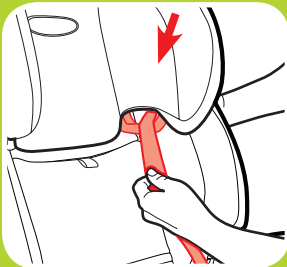

⚠ WARNING!

Use only the vehicle lap and shoulder belt system when restraining the child in the booster seat.

1. Place Child In Seat

Have your child sit in the booster seat, with his/her back flat against the back of the booster seat.

2. Thread Vehicle's Shoulder Belt Into Seat Belt Guide in the Headrest

3. Buckle the Vehicle Lap/Shoulder Seat Belt

Pull up on the shoulder belt to remove all the slack. Be sure the lap portion of the vehicle seat belt goes behind the armrests.

Be sure the lap portion of the vehicle seat belt lies low across your child's hips.

Be sure the shoulder belt lies across your child's shoulders, between the neck and edge of shoulder. The belt guides should be even with or just above the shoulders.

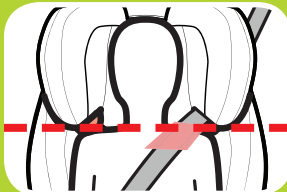
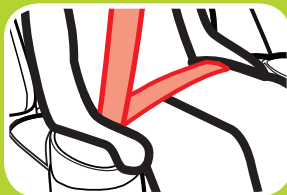

**5 Securing
Child**





5 Securing Child

Is Everything Correct?



Never Use Lap Belt Only

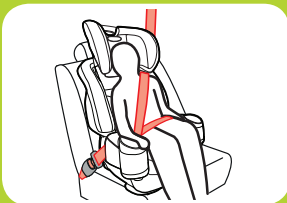

Lap Belt Behind Armrest and Lies Low Across Hips and Thighs

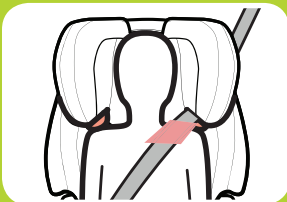

Shoulder Belt Lies On the Shoulder, Between the Neck and Edge of Shoulders

5-C Securing Child Backless Booster

⚠ WARNING!

Use only the vehicle lap and shoulder belt system when restraining the child in the booster seat.

1. To Use This Backless Booster For Children Over 100 lb (45 kg), You Must Remove the Cup Holders

To remove the cup holders, slide the button out and remove cup holder. Reverse steps to replace cup holders.

2. Place Child In Seat

Have your child sit in the booster seat, with his/her back flat against the back of the vehicle seat.

3. Ears Must Be Below the Top of the Vehicle Seat Back or Headrest

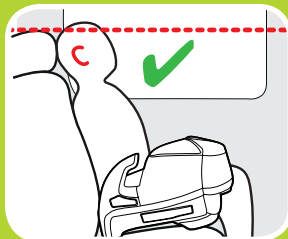
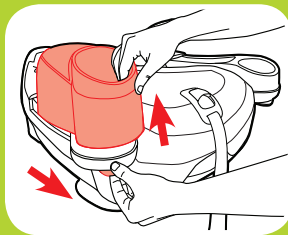

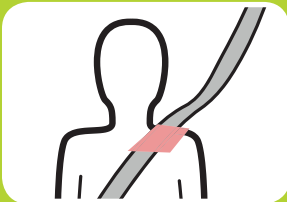

4. Buckle the Vehicle Lap/Shoulder Seat Belt

Pull up on the shoulder belt to remove all the slack. Be sure the lap portion of the vehicle seat belt goes behind the armrests.

Be sure the lap portion of the vehicle seat belt lies low across your child's hips.

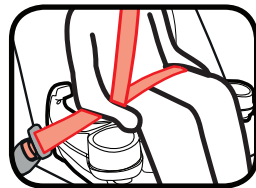
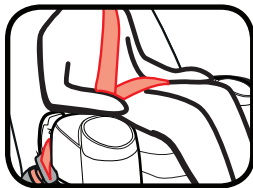

Be sure the shoulder belt lies across your child's shoulders, between the neck and edge of shoulder.

You may need to use the belt positioning clip to help get a good fit.

Is Everything Correct?

Never Use Lap Belt Only



Lap Belt Behind Armrest and Lies Low Across Hips and Thighs

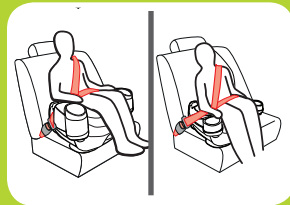

Shoulder Belt Lies On the Shoulder, Between the Neck and Edge of Shoulders

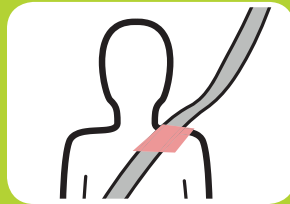

**5 Securing
Child**



Using Belt Positioning Clip

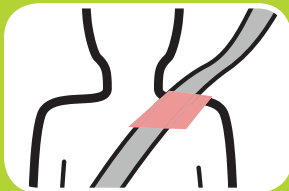

1. **Make Sure Vehicle's Seat Shoulder Belt Lays in the Red Zone As Shown**

If the vehicle's seat shoulder belt lays outside this zone, you **MUST** use the belt positioning clip.

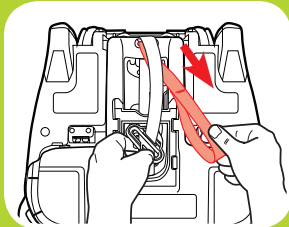

2. **Attach Belt Positioning Clip**

The shoulder belt positioning clip **MUST** be attached to the slot on the bottom of the base. Insert the loop end of strap through the slot on bottom of seat exactly where shown.

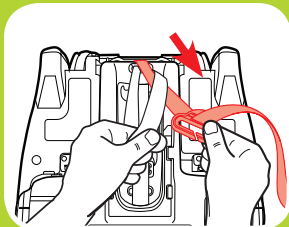

3. **Push Clip and Strap Through Loop**

Pass the clip and the strap through the loop end as shown and pull strap up.

4. Free End of Strap Should Face Front of Seat

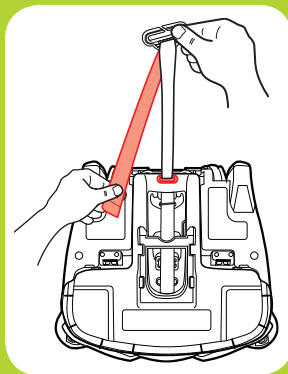

5. Place Child in Seat, Buckle Child In Seat and Attach Belt Positioning Clip

With child's back flat against the back of the vehicle seat, buckle child in. Then slide the clip onto the vehicle's seat shoulder belt as shown.

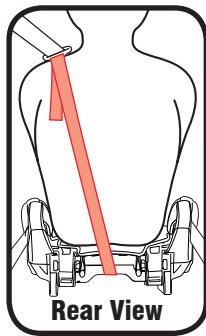

87

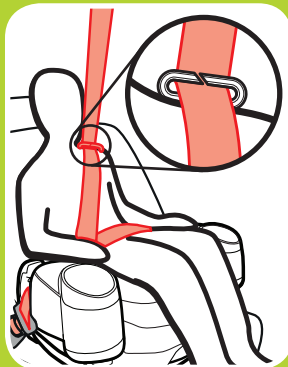

5 Securing
Child



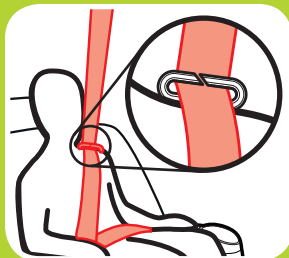
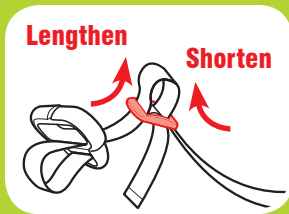

6. Adjust the Belt Positioning Clip to Fit Your Child

Lengthen or shorten the belt length as shown.

Clip should fit right at the top of shoulder as shown.

Pull up on the shoulder belt to remove all the slack. Be sure the lap portion of the vehicle seat belt goes behind the armrests.

6-A Accessories *(on select models)*

Harness Covers

Make sure that harness covers do not interfere with placement of the chest clip at armpit level.

To remove, undo the fastening strips and remove.

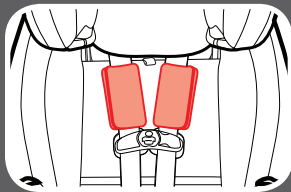

Buckle Covers

To remove, undo the fastening strips and remove.

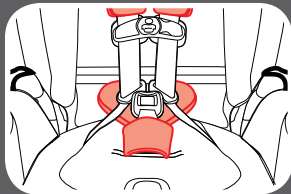

Body Support Pads

Body support must be used if shoulders are below the lowest harness setting.

Never allow body support to bunch or fold behind child.

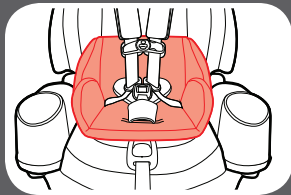



7-A How to Remove InRight™ LATCH and Top Tether

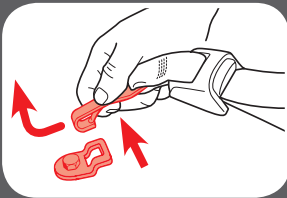
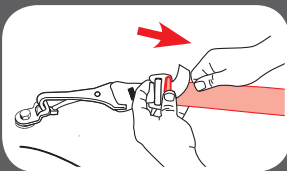
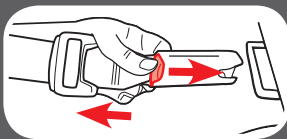

InRight™ LATCH

To remove the InRight™ LATCH from the lower anchors, push in on the buttons and pull them off.

Top Tether

To remove, press the grey button and pull out on the strap to release the tension.

Press in on the hook's spring. Push tether hook in, then lift up and pull away from tether anchor.

7-B Choosing Vehicle Seat Location



Review your vehicle's owner manual for Seating Locations

The best seating location for this car seat is one that:

- Is recommended by your vehicle owner's manual, and
- Results in a secure installation of this car seat

In the event there is no available back seat and / or you have no other option, the National Highway Traffic Safety Administration (NHTSA) recommends that you take the following steps:

- Ensure the child is properly restrained according to their age and size
- Move the seat as far back as possible
- Make sure the child is not leaning out of position, such as leaning forward into the deployment path of the air bag
- Set the air bag ON-OFF switch, if available, to the OFF position



7-C Unsafe Vehicle Seat Location

Never install this car seat in any of the following vehicle seating locations:



rear-facing or side-
facing vehicle seats



booster mode with vehicle
lap belt only seat belt



7-D Vehicle Seat Belts

Review your vehicle's owner manual for vehicle seat belt use

This car seat can be installed using a vehicle seat belt. To do this, you will need to change the seat belt to a locked mode for use with car seats. With some vehicle seat belts, this is done with the latch plate; with other vehicle seat belts, this is done with the retractor.

Vehicle Seat Belt Terms

Retractor

A device that winds up the unused vehicle seat belt. It is often hidden inside the panels on the walls of the vehicle or in the vehicle seatback.

Latch Plate

The male end of the seat belt with the silver tongue.

Seat Bight

The crease where the vehicle seat back and seat bottom meet.

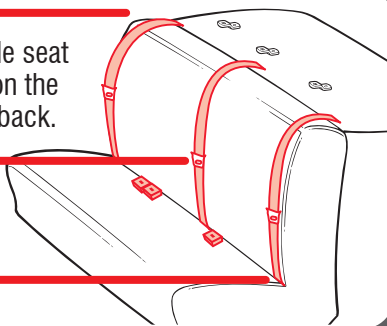



Identify Your Seat Belt Type

There are two different types of vehicle seat belts that can be used with this car seat:

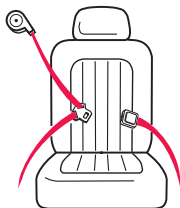

Lap/Shoulder Belt

3 connections points. Can be used in all car seats modes of use.

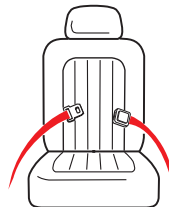

Lap Belt Only

2 connection points. **Can ONLY be used in harness mode.**

The following types of vehicle seat belts **CANNOT** be used safely with this car seat:



Lap Belt with Motorized
Shoulder Belt



Lap Belt or Shoulder
Belt Mounted on Door

Belts Forward of the
Seat Bight

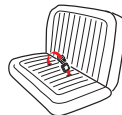

Some vehicles you may not get a secure fit. Read both your vehicle and car seat manuals.

Lap/Shoulder Belt Installation



Always review your vehicle owner's manual for specific information about your vehicle seat belts.

There are three types of retractors: **ELR (Emergency Locking Retractor)**, **ALR (Automatic Locking Retractor)**, and **Switchable (ELR switch to ALR)**. To determine your type of retractor, follow these steps:

1. **Slowly** pull the belt out about halfway and stop.
2. Let the belt retract back several inches.
3. Try to **slowly** pull the belt out more. If the belt cannot be pulled any further, it is **ALR**. If it can be pulled further, go to the next step.
4. **Slowly** pull the belt all the way out, and then allow it to retract several inches.
5. Try to pull the belt all the way out again. If it cannot be pulled out, it is **Switchable**. If it can still be pulled out freely, it is **ELR**.



Note: Most vehicles manufactured after 1996 will have Switchable retractors in the back seat. If you have any questions about your retractor type, consult your vehicle owner's manual or call Graco for assistance.



How to Lock Your Lap and Shoulder Vehicle Seat Belt



Sliding Latch Plate and Switchable Retractor

A latch plate that slides freely on the belt webbing and cannot, by itself, hold the belt snug around a car seat.

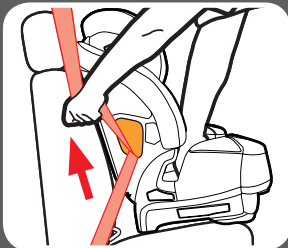

When installing the car seat, route the vehicle seat belt through the proper belt path and buckle it in. **Slowly pull the shoulder belt all the way out to switch it to locking mode.** Then, as you pull the vehicle seat belt tight, feed all the slack back into the retractor.

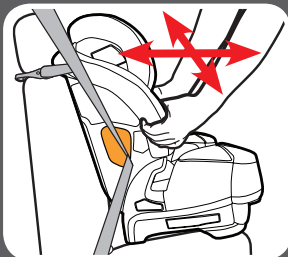

Grab the sides of the seat at the belt path and slide the seat side-to-side and front-to-back. The seat should not move more than 1" (2.5 cm).



Locking Latch Plate and ELR Retractor

A latch plate that holds the lap belt snug after it has been adjusted; contains a metal bar on the underside of the hardware that “locks” the belt in position.

When installing the car seat, route the vehicle seat belt through the proper belt path and buckle it in. Then, pull upwards on the shoulder belt so that the lap belt gets tight around the car seat.

Grab the sides of the seat at the belt path and slide the seat side-to-side and front-to-back. The seat should not move more than 1” (2.5 cm).

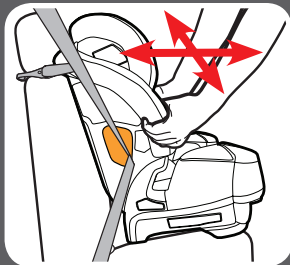
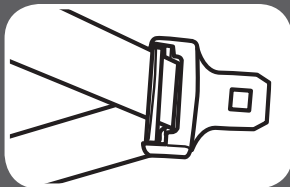

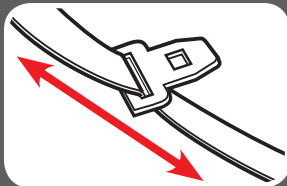

Sliding Latch Plate and ALR Retractor

A latch plate that slides freely on the belt webbing and cannot, by itself, hold the belt snug around a car seat.

Slowly pull the shoulder belt all the way out. Route the vehicle seat belt through the proper belt path and buckle it in. Then, as you pull the vehicle seat belt tight, feed all the slack back into the retractor.

Grab the sides of the seat at the belt path and slide the seat side-to-side and front-to-back. The seat should not move more than 1" (2.5 cm).

Note: If using the lock-off, you do not need to switch the retractor.



Sliding Latch Plate and ELR Retractor

A latch plate that slides freely on the belt webbing and cannot, by itself, hold the belt snug around a car seat.

With this retractor, you will need to use the locking clip to lock the vehicle seat belt.

Call us at 1-800-345-4109 to order a locking clip.

Route the vehicle seat belt through the proper belt path and buckle it in. Pull the vehicle seat belt tight. While pushing down on seat, pinch the two straps together behind the buckle tongue. Unbuckle the belt without allowing it to slip.

Attach locking clip to lap and shoulder belts as shown.

Rebuckle belt. Check that lap belt does not move by pulling hard. If belt loosens or lengthens, repeat procedure.

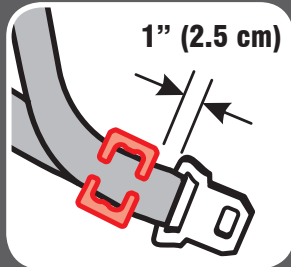
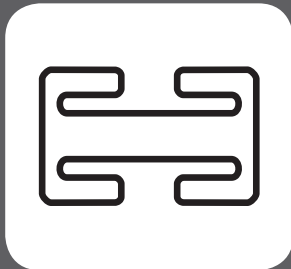
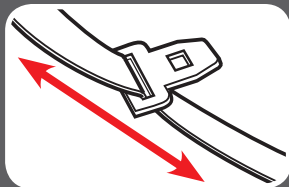



Lap Belt Installation - DO NOT use in Booster Mode

Always review your vehicle owner's manual for specific information about your vehicle seat belts.



Grab the sides of the seat at the belt path and slide the seat side-to-side and front-to-back. The seat should not move more than 1" (2.5 cm).

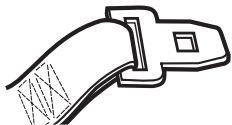

Locking Latch Plate and No Retractor

When installing the car seat, route the lap seat belt through the proper path and buckle it in. Then, pull upwards on the tail of the belt so that the lap belt gets tight around the car seat.

Sewn On Latch Plate and ALR

Slowly pull the lap belt all the way out. Route the vehicle seat lap belt through the proper belt path and buckle it in. Then, pull the lap belt tight while feeding all the slack back into the retractor.

Note: If you use the lock-off, you do not need a locking clip.

8-A Cleaning Cover

Refer to seat pad care tag for washing instructions.

Headrest Pad

Clean with a damp sponge using mild soap and cool water. If needed, the headrest pad may be removed for cleaning.

To remove, unhook elastic loops and snaps from headrest as shown.

Remove headrest pad.

Machine wash pad in cold water on delicate cycle and drip-dry. **DO NOT USE BLEACH.**

Reverse the steps to reattach the pad on the headrest.

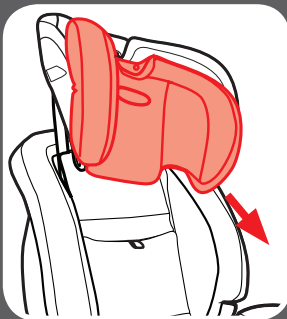
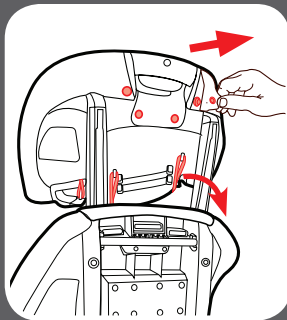

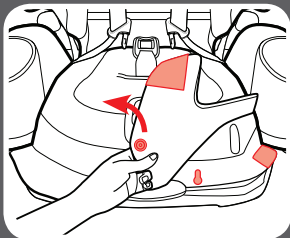
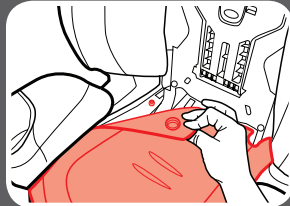
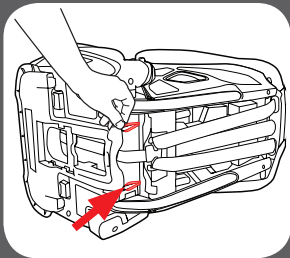

Seat Base Pad

Clean with a damp sponge using mild soap and cool water. If needed, seat pad may be removed for cleaning.

To remove base pad, unhook the elastic loops from back.

From the top, undo the fastening strips and unsnap the snaps.

From the front, pull down on the corners and pull down on the tap to remove from keyhole. Pull base pad off base.

Machine wash pad in cold water on delicate cycle and drip-dry. **DO NOT USE BLEACH.**

Reverse the steps to reattach the seat base pad.

Lower Backrest Pad

Clean with a damp sponge using mild soap and cool water. If needed, lower backrest pad may be removed for cleaning.

To remove lower backrest pad, pull the top of the pad off the seat back and undo both snaps and remove.

Machine wash pad in cold water on delicate cycle and drip-dry. **DO NOT USE BLEACH.**

Reverse the steps to replace the lower backrest pad.

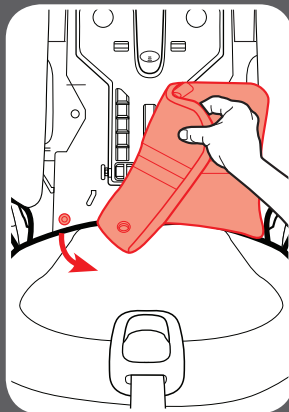

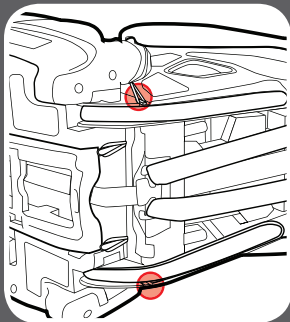
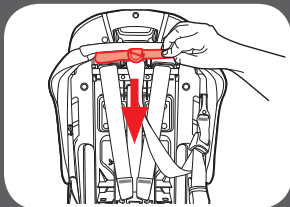
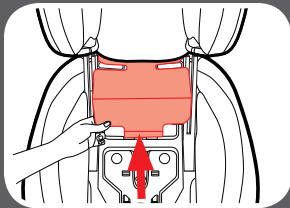

Upper Backrest and Side Pad

Clean with a damp sponge using mild soap and cool water. If needed, backrest pad may be removed for cleaning.

To remove, from the front, pull upper backrest pad out of backrest. From the back, pull the plastic tab from the back of the backrest.

Undo both elastic straps from the sides.

From the top, pull the pad off of the shell.

Machine wash pad in cold water on delicate cycle and drip-dry. **DO NOT USE BLEACH.**

Reverse the steps to reattach the upper backrest and side pad.

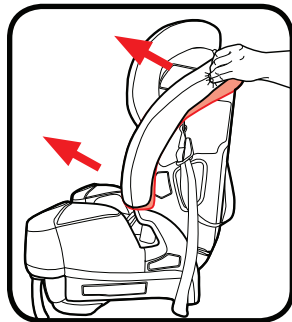

8-B Cleaning Rapid Remove™ Cover

Refer to seat pad care tag for washing instructions.

Headrest Pad

Clean with a damp sponge using mild soap and cool water. If needed, headrest pad may be removed for cleaning.

To remove, unhook elastic loops and snaps from headrest as shown.

Remove headrest pad.

Machine wash pad in cold water on delicate cycle and drip-dry. **DO NOT USE BLEACH.**

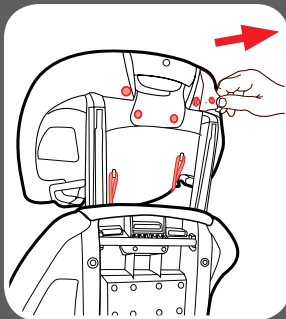

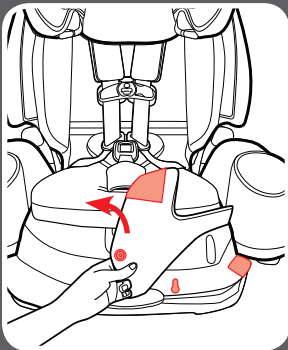
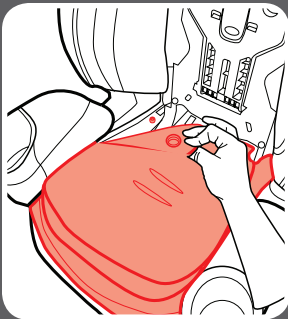

Seat Base Pad

Clean with a damp sponge using mild soap and cool water. If needed, seat base pad may be removed for cleaning.

To remove base pad, from the top, unsnap the two snaps.

From the front, pull down on the corners and pull down on the tab to remove from the keyhole. Pull base pad off of base.

Machine wash pad in cold water on delicate cycle and drip-dry. **DO NOT USE BLEACH.**

Lower Backrest Pad

Clean with a damp sponge using mild soap and cool water. If needed, lower backrest pad may be removed for cleaning.

To remove lower backrest pad, pull the top of pad off the seat back and undo both snaps and remove.

Machine wash pad in cold water on delicate cycle and drip-dry. DO NOT USE BLEACH.

Upper Backrest Pad

Clean with a damp sponge using mild soap and cool water. If needed, upper backrest pad may be removed for cleaning.

To remove, from the back of the seat, pull out the plastic tab from the backrest.

From the front, pull pad out from the seat back and remove the upper backrest pad.

Machine wash pad in cold water on delicate cycle and drip-dry. DO NOT USE BLEACH.

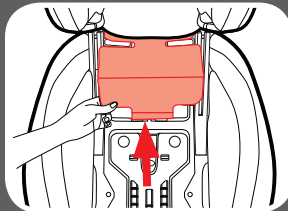
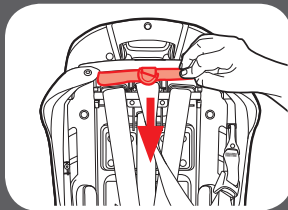
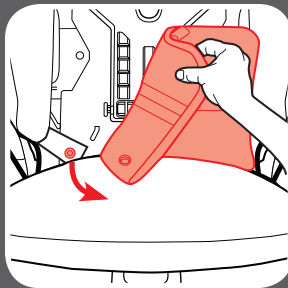

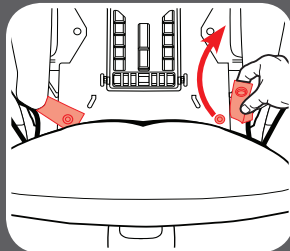
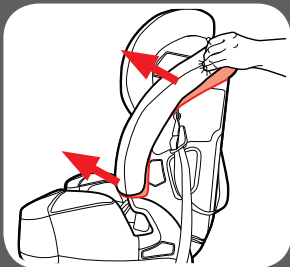
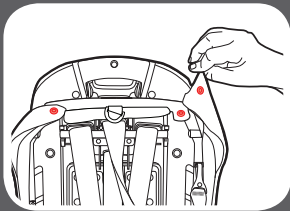

Side Wing Pads

Clean with a damp sponge using mild soap and cool water. If needed, side wing pads may be removed for cleaning.

To remove the side wing pads, from the back, unfasten the two snaps.

From the front, unfasten the two lower snaps. Pull side wing pads off of seat back.

Machine wash pad in cold water on delicate cycle and drip-dry. **DO NOT USE BLEACH.**

Follow these steps to reattach the Rapid Remove Cover.

Side Wing Pads

To reattach the side wing pads, from the front, resnap the two lower snaps.

Pull side wing pads onto the seat back.

From the back, resnap the two snaps.

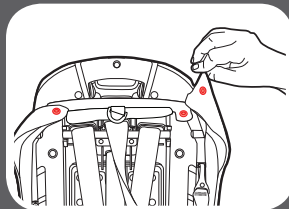
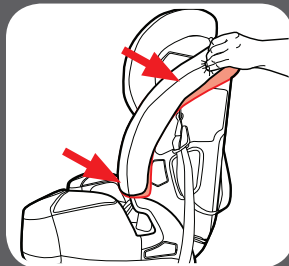
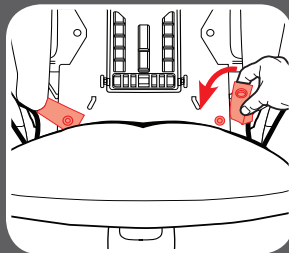

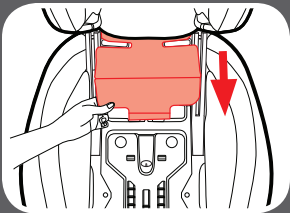

Upper Backrest Pad

To reattach the upper backrest pad, from the front, pull pad down from the seat back and tuck the front tab into the shell.

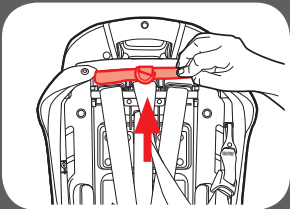

From the back of the seat, push the plastic tab up and into the backrest.

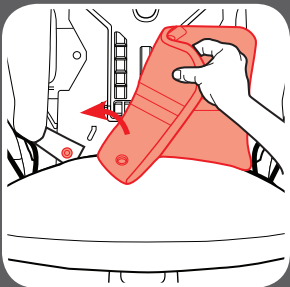

Lower Backrest Pad

To reattach lower backrest pad, resnap both lower snaps and push the top buttons into the shell.

Seat Base Pad

To reattach the seat base pad, pull down the seat base pad and push the tab into the keyhole. Slide the pocket of the seat base pad over the seat base corner near the armrest.

From the top, resnap the two snaps.

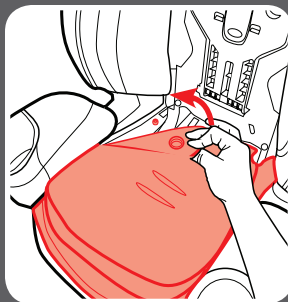
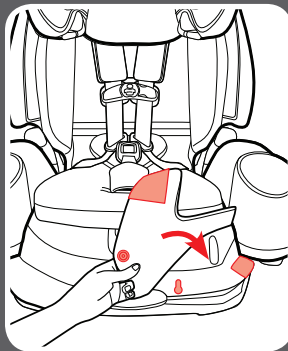

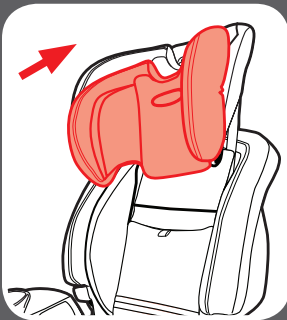

Headrest Pad

To reattach, pull headrest pad over the headrest.

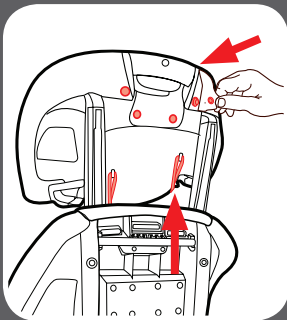

From the back, hook elastic loops and close the snaps on the headrest as shown.

8-C Cleaning Buckle Strap

From bottom of car seat, rotate metal retainer to side in order to push it through slot easier. Pull buckle strap from child restraint as shown.

To clean buckle, place in a cup of warm water and gently agitate the buckle. Press the red button several times while in the water.

DO NOT SUBMERGE THE BUCKLE STRAP. DO NOT USE SOAPS, HOUSEHOLD DETERGENTS or LUBRICANTS.

Shake out excess water and allow to air dry. Repeat steps as needed until it fastens with a click. Re-insert the buckle into the same slot it was removed. Pull up on buckle strap to make sure it is secured.

WARNING! Inspect and clean buckle from time to time to remove any objects or debris that could prevent latching.

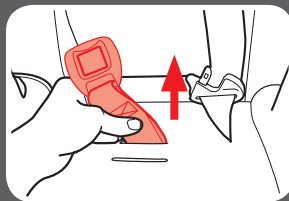
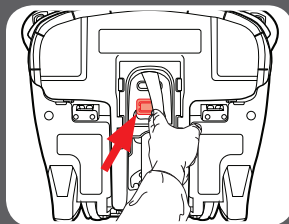

8-D Cleaning Harness and InRight™ LATCH Straps

Surface wash only with mild soap and damp cloth. **DO NOT IMMERSE THE HARNESS STRAPS or InRight™ LATCH STRAP IN WATER** Doing so may weaken the straps.

If harness straps or InRight™ LATCH belt are frayed or heavily soiled, contact Customer Service at www.gracobaby.com or 1-800-345-4109.



8 Care &
Cleaning

8-E Cleaning Removable Cup Holders

To remove the cup holders, slide the button out and remove cup holder. The cup holders are dishwasher safe.

To reattach : with the cup holder's storage compartment facing in, slide the tab on the back of the cup holder under the booster belt path and snap into place.

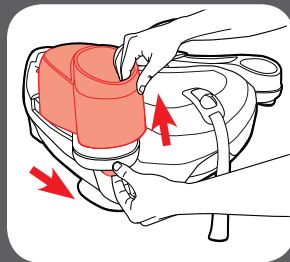

Replacement Parts

To purchase parts or accessories in the United States,
please contact us at the following:

www.gracobaby.com

or

1-800-345-4109

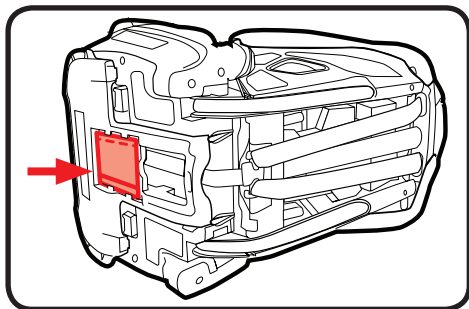

Store instruction manual in
the slot with the instruction
book icon as shown.