



*featuring*

**Extend2Fit<sup>®</sup>**

**SAFETY  
SURROUND**  
SIDE IMPACT PROTECTION

**CONVERTIBLE CAR SEAT**

**Read This Instruction Manual**

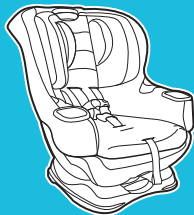
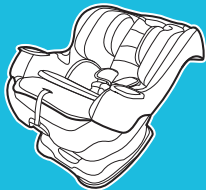

NWL0000674611A 9/17

**Do not install or use this child restraint until you read and understand the instructions in this manual.**

**FAILURE TO PROPERLY USE THIS CHILD RESTRAINT INCREASES THE RISK OF SERIOUS INJURY OR DEATH IN A SUDDEN STOP OR CRASH.**

# 1 Important

*Pages 6-23*

**1-A A Quick Guide to Your Manual**

**1-B Welcome to the Graco Family**

**1-C Right Mode of Use**

**1-D Before You Begin**

Register This Car Seat

If You Need Help

Certification

Car Seat's Useful Life

Vehicle Seat Protection

Warm Weather Use

**1-E Safety Warnings**

# 2 Features

*Pages 24-29*

**2-A Car Seat Features**

## **3 Rear-Facing Use**

*Pages 30-47*

- 3-A Rear-Facing**
- 3-B Installing Rear-Facing With LATCH Straps**
- 3-C Install Rear-Facing With Vehicle Seat Belt**

## **4 Forward-Facing Use**

*Pages 48-61*

- 4-A Forward-Facing**
- 4-B Installing Forward-Facing With LATCH Straps**
- 4-C Install Forward-Facing With Vehicle Seat Belt**

## **5 Securing Child**

*Pages 62-69*

### **5-A Securing Child 5-Point Harness**

## **6 Accessories**

*Page 70*

## **7 Moving the LATCH Strap**

*Pages 71-73*

## **8 Additional Information**

*Pages 74-84*

- 8-A How to Remove LATCH and Top Tether**
- 8-B Choosing Vehicle Seat Location**
- 8-C Unsafe Vehicle Seat Locations**
- 8-D Vehicle Seat Belts**

## **9 Cleaning Seat Pad**

*Pages 85-95*

- 9-A Cleaning Seat Pad**
- 9-B Cleaning Crotch Buckle**
- 9-C Cleaning Harness and LATCH Straps**

## 1-A A Quick Guide to Your Manual

**This car seat is for children: *Rear-Facing: 4-50 lb (1.8-22.5 kg)*  
*Forward Facing: 22-65 lb (10-30 kg)***

- Children less than 22 lb (10 kg) **MUST** use this car seat rear-facing. Review section 1-C for more information.

### ***Car Seat Assembly (On Select Models)***

#### ***Adult Assembly Required***

##### ***1. Attach Cup Holders***

**You MUST attach cup holders.** Remove seat cover. Line up tab on bottom of cupholder with hole in shell. Press and snap into place. Replace cover.

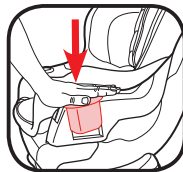
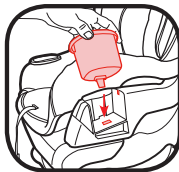

### ***Get to Know Your Car Seat***

Review section 2-A to see all of the features of this car seat.

### ***What Seating Location Should I Use?***

***The best seating location for this car seat is one that:***

- Is recommended by your vehicle owner's manual, and

- Results in a secure installation of this car seat.

Some vehicles have specific requirements for where the car seat can be installed, so be sure to check your vehicle owner's manual for available seating positions, if any.

Review section 8-B, 8-C of this manual AND your vehicle owner's manual.

**According to accident statistics, the safest place for your child in any vehicle is the back seat. The center of the back seat can be the safest during a possible side impact.**



### ***Which Installation Method Should I Use?***

This car seat can be installed in your vehicle using either the vehicle seat belt **OR** the LATCH system. Both are equally safe to use. **DO NOT USE BOTH AT THE SAME TIME.**

**Vehicle Seat Belt:** Review section 8 and your vehicle owner's manual to learn how to install your car seat with the vehicle seat belts.

**LATCH:** The LATCH system allows you to securely attach your safety seat in your car without using the vehicle seat belt and possibly to get a better fit. All 2003 and newer model year vehicles are required to have a LATCH system, although some manufacturers began including LATCH earlier. Some vehicle owner manuals use the term ISOFIX to identify the LATCH system.

## What is LATCH?

LATCH consists of lower anchors and top tether anchors, which are built-in to your vehicle, and connecting hooks that are built-in to your car seat. Lower anchors are used **INSTEAD** of the vehicle's seat belt to secure the child seat to the vehicle. Top tethers are used **IN ADDITION** to the lower anchors **OR** the vehicle's seat belt to secure a forward-facing car seat to the vehicle.

***Review your vehicle's owner manual for exact location and use.***

**Vehicle Top Tether  
Anchor Points**

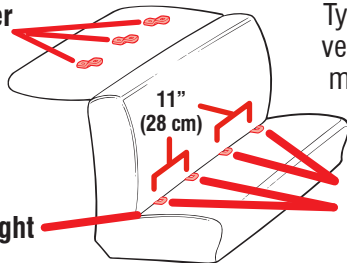

**Vehicle Seat Belt**

Typical seat in a passenger vehicle. Other vehicle types may have different LATCH locations.

**Vehicle Lower  
Anchor Points**





## When Installing Rear-Facing & Forward-Facing

### LATCH System

LATCH consists of two lower anchors, which are built-in to your vehicle, and connectors that are built-in your car seat.

Review section 3-B & 4-B of this manual AND your vehicle owner's manual.

**LATCH can ONLY be used if the vehicle LATCH anchor spacing is 11 inches (28 cm) from the center of one LATCH anchor to the center of the other LATCH anchor.**

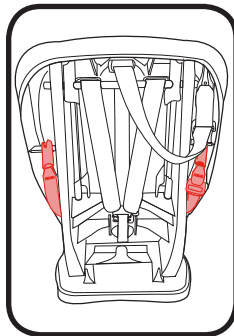
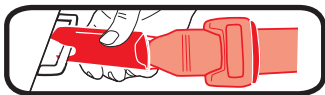

### Vehicle Seat Belt

There are two types of vehicle seat belts that can be used. Lap/Shoulder Seat Belt or Lap Only Seat Belt.

Review section 3-C & 4-C of this manual AND your vehicle owner's manual.

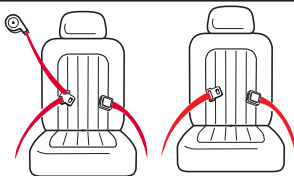

1 Important

## ***Does Your Car Seat Fit Your Child Correctly?***

To make sure your child is secured properly, review section 3 and 4 to understand all of the actions you need to take to properly adjust the car seat to fit your child.

### ***For Rear-Facing, You Need to Adjust:***

#### **Harness Height, Rear-Facing (A)**

Harness straps at or just below the child's shoulders and top of head **must** be at least 1" (2.5 cm) below the headrest adjustment lever (B). Review section 5.

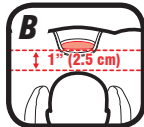

#### **Buckle Position (C)**

The correct slot is the one that is closest to your child without being underneath them. Review section 5.

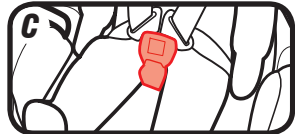

#### **Harness Tightness (D)**

If your fingers slide off the harness straps without pinching the straps, it is tight enough. Review section 5.

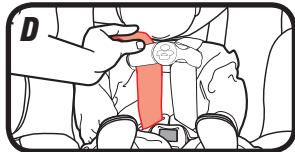



1 Important

## ***For Forward-Facing, You Need to Adjust:***

### **Harness Height, Forward-Facing (A)**

Harness straps at or just above the child's shoulders and top of child's ears below top of headrest **(B)**. Review section 5.

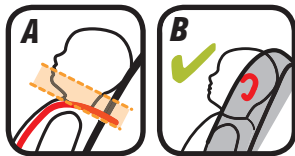

### **Buckle Position (C)**

The crotch strap must be in the front-most slot when forward facing.

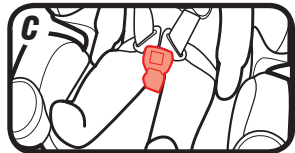

### **Harness Tightness (D)**

If your fingers slide off the harness straps without pinching the straps, it is tight enough. Review section 5.

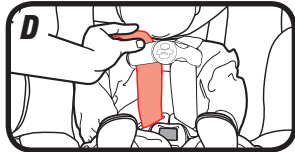

## Rear-Facing Installation

**Car Seat Does Not Move More than 1" (2.5 cm) at the Belt Path (A)**

Review section 3

**Check level indicator (B)**

Review section 3

**Harness Straps at or Just Below Child's Shoulders (C)**

Review section 5

**Chest Clip Even With Armpits (D)**

Review section 5

**Cannot Pinch Harness Straps at the Shoulder (E)**

Review section 5

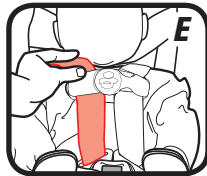
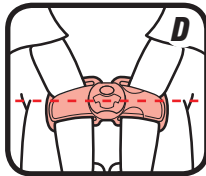
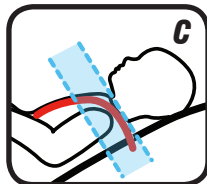
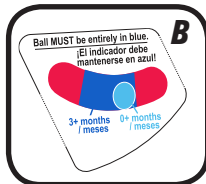
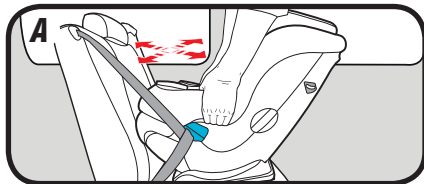

## Forward-Facing Installation

### Use the top tether strap when using forward-facing (A)

When used properly, the top tether helps reduce injury in a sudden stop or crash.

Review section 4

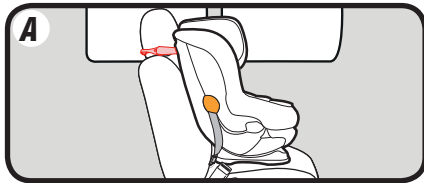

### Car Seat Does Not Move More than 1" (2.5 cm) at the Belt Path (B)

Review section 4

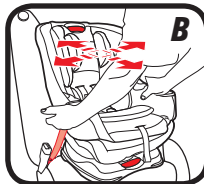

### Harness Straps at or Just Above Child's Shoulders (C)

Review section 5

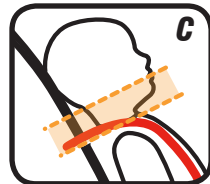

### Chest Clip Even With Armpits (D)

Review section 5

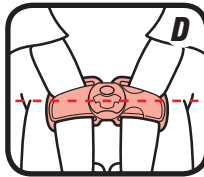

### Cannot Pinch Harness Straps at the Shoulder (E)

Review section 5

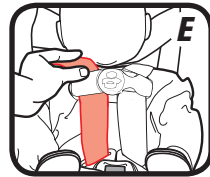

**i** 1 Important



**1 Important**

## **1-B Welcome to the Graco Family!**

Your child's safety depends on you. No car seat can guarantee protection from injury in every situation, but proper use helps reduce the risk of serious injury or death.

Even if this car seat seems easy to figure out on your own, you must follow the detailed instructions in this instruction manual to ensure the steps below are performed correctly.



1 Important

## 1-C Right Mode of Use

4 lb (1.8 kg)	22 lb (10 kg)	50 lb (22.5 kg)	65 lb (30 kg)
------------------	------------------	--------------------	------------------

### Rear-Facing with 5-Point Harness

4-22 lb (1.8-10 kg) less than 1 year old **MUST** be rear-facing.

22-50 lb (10-22.5 kg) **CAN** be rear-facing.

### Forward-Facing with 5-Point Harness

22-50 lb (10-22.5 kg) can sit upright unassisted **CAN** be forward-facing.

50-65 lb (22.5-30 kg) **MUST** be forward-facing.

\* Check your state laws and the AAP/NHTSA recommendations. See page 21.



1 Important

## 1-D Before You Begin

### *Register This Child Restraint*

Please fill out the prepaid registration postcard attached to the harness and mail it in today **or register online at [www.gracobaby.com/carseatregistration](http://www.gracobaby.com/carseatregistration).**

Child restraints could be recalled for safety reasons. You must register this restraint to be reached in a recall. Send your name, address, and the restraint's model number and manufacturing date to:

Graco Children's Products, Inc.

Attn: Customer Service

P.O. Box 169, Elverson, PA 19520-9901

or call 1-800-345-4109

**or register online at**

**[www.gracobaby.com/carseatregistration](http://www.gracobaby.com/carseatregistration)**

For recall information, call the U.S. Government's Vehicle Safety Hotline at 1-888-327-4236 (TTY: 1-800-424-9153), or go to <http://www.NHTSA.gov>.



For future reference or if you change addresses, record the model name, model number, date of manufacture and purchase date of this car seat on the below. You can find this information either on the registration card if you still have it or on the date label located on the back of the car seat.

**Model Name** \_\_\_\_\_

**Model Number** \_\_\_\_\_

**Date of Manufacture** \_\_\_\_\_

**Date of Purchase** \_\_\_\_\_

### ***If You Need Help***

In the U.S.A, please contact our Customer Service Department with any questions you may have concerning parts, use, or maintenance. When you contact us, please have your product's model number and date of manufacture ready so that we may help you efficiently. These numbers can be found on a sticker on the back side of your car seat.

For additional resources or to get your car seat checked by a child passenger safety technician, please visit the following web sites:

[www.nhtsa.gov](http://www.nhtsa.gov) • [www.seatcheck.org](http://www.seatcheck.org) • [www.safekids.org](http://www.safekids.org)



## ***Certification***

This child restraint meets or exceeds all applicable requirements of Federal Motor Vehicle Safety Standard 213 for use in motor vehicles.



This child restraint is certified for use in aircraft. Use only on forward-facing aircraft seats. Follow the instructions for vehicle installation. For rear-facing installation, see section 3-C and 8-D Lap Belt Installation. For forward-facing installation, see section 4-C and 8-D Lap Belt Installation, but do not use top tether.. Contact the airline for their specific polices.

## ***Car Seat's Useful Life***

STOP using this car seat and throw it away 10 years after the date of manufacture. Look for this sticker on back of the car seat.

Graco Children's Products Inc. advises against loaning or passing along a car seat unless you know the complete history of the product. We also advise against purchasing a car seat second hand.

## ***Vehicle Seat Protection***

Protect vehicle seat. Use a car seat mat, towel, or thin blanket under and behind car seat.

## ***Warm Weather Use***

Car seat parts can get very hot in the sun or warm weather. **To avoid burns, always check before putting child in car seat.**

## **1-E Safety Warnings**

**No car seat can guarantee protection from injury in every situation, but proper use helps reduce the risk of serious injury or death. READ THIS MANUAL CAREFULLY.**

### **⚠️ WARNING!**

**Failure to follow these instructions and child restraint's labels can result in child striking the vehicle's interior during a sudden stop or crash.**



**1 Important**

**1 Important**



**! NEVER PLACE THIS CHILD RESTRAINT REAR-FACING IN A VEHICLE SEATING LOCATION THAT HAS AN ACTIVE FRONT AIR BAG.**

If an air bag inflates, it can hit the child and car seat with great force and cause serious injury or death to your child.

**! Review your vehicle owner's manual for more information about air bags and car seat use.**

**! If your vehicle does not have a back seat, review your vehicle owner's manual.**



**1 Important**

- ! The American Academy of Pediatrics (AAP) recommends that children ride rear-facing until the age of 2 or until they reach the maximum rear-facing height or weight rating for their seat, and when forward-facing, children should use the built-in harness system for as long as possible until they reach the maximum forward-facing weight or height for their car seat.**
- ! Choose the correct mode of use for the car seat depending on your child's size. Infants less than 22 lb. (10 kg) MUST use this car seat rear-facing.**
- ! Select a suitable location for the car seat in your vehicle.**
- ! Secure car seat with a vehicle seat belt or LATCH that is properly routed as shown in this manual.**



## 1 Important

- ! Vehicle seat belt system MUST hold car seat securely. Not all vehicle seat belts can be used with a car seat.**
- ! If vehicle seat belt does not hold car seat securely, read “Vehicle Seat Belts” section 8-D and your vehicle owner’s manual.**
- ! Always secure car seat with LATCH or a vehicle seat belt, even when unoccupied. In a crash, an unsecured car seat can injure passengers.**
- ! If car seat is in a crash, it must be replaced. DO NOT use it again! A crash can cause unseen damage and using it again could result in serious injury or death.**
- ! DO NOT use car seat if it is damaged or missing parts.**
- ! DO NOT use accessories or parts other than those provided by Graco. Their use could alter the performance of the car seat.**
- ! DO NOT remove LATCH system from car seat. If using vehicle seat belt to secure car seat, LATCH connectors must be stored.**



**! Never leave child unattended, even when sleeping. Child may become tangled in harness straps and suffocate or strangle.**

**! Rear-facing car seat must be properly leveled:**

- Too reclined can result in injury or ejection.
- Too upright can result in breathing difficulties.



**! Never attach two LATCH connectors to one vehicle lower anchor point unless specifically allowed by the vehicle manufacturer.**

**! Do not use both the vehicle belt and LATCH belts at the same time when using the car seat rear or forward facing.**

**Note:** Preterm or low birth weight infants may be at special risk in a vehicle or aircraft. According to the AAP, these infants may suffer breathing issues if improperly reclined in a car seat. When rear-facing, use the corrected age for preemies. Graco advises that you have your physician or hospital staff evaluate your infant and recommend the proper car seat or car bed before you and your infant leave the hospital.

## 2-A Car Seat Features

2 Features

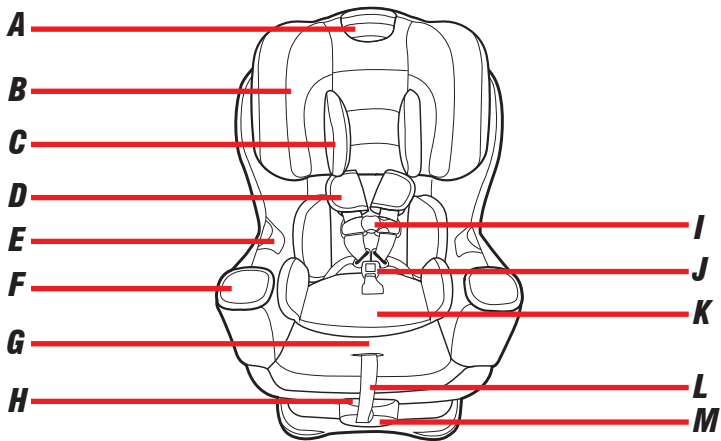



- A Height Adjust Lever***
- B Headrest***
- C Head Support***
- D Harness Cover***
- E Buckle Pockets***
- F Cupholder***
- G Harness Release Lever***  
*(under seat pad)*
- H Extender Handle***
- I Chest Clip***
- J Harness Buckle***
- K Body Support***
- L Harness Adjustment Strap***
- M Base Recline Handle***

**2 Features**

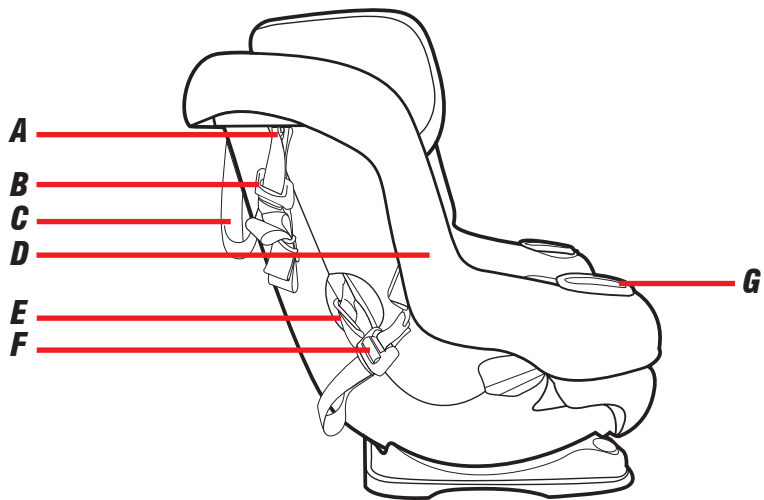

- A Tether Hook**
- B Tether Adjuster**
- C Tether Strap**
- D LATCH Storage**
- E LATCH Strap**
- F LATCH Adjuster**
- G Cup Holder**
- H Level Indicator**

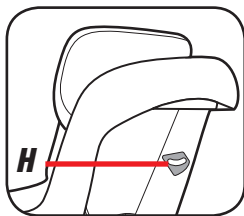

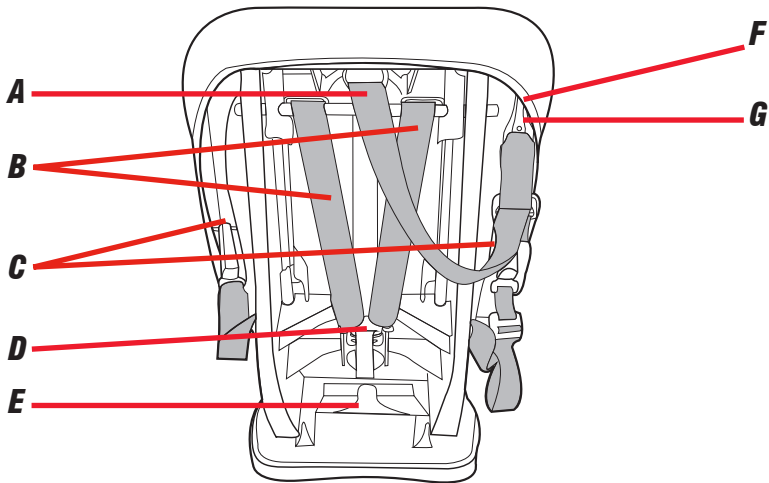

- A Tether Strap***
- B Harness Straps***
- C LATCH Storage***
- D Splitter Plate***
- E Instruction Manual Storage***
- F Tether Storage***
- G Tether Hook***

## 3-A Rear-Facing

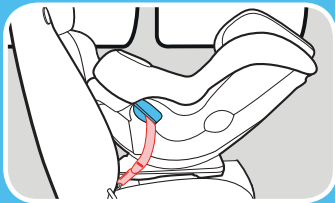

### **LATCH Strap**

***Do not install by this method for a child weighing more than 45lb (20kg)***



**3 Rear Facing**

\*Check your state laws and the AAP/NHTSA recommendations.

### **Rear-Facing: 4-50 lb (1.8-22.5 kg)\***

- Infants who weigh less than 22 lb (10 kg) **MUST** be rear-facing.
- Place car seat rear-facing in the vehicle back seat.
- Make sure LATCH strap or vehicle seat belt is routed through the rear-facing belt path marked with a blue label.
- Install this car seat tightly in your vehicle. Car seat **should not move** at the rear-facing belt path more than 1". (2.5 cm) from side to side, front to back.
- Check recline level making sure the ball is within the blue area.

- Harness straps need to be **even with or just below** the top of child's shoulders and chest clip is at **armpit level**.
- The American Academy of Pediatrics (AAP) recommends that children be rear-facing until the age of 2 or until they reach the maximum rear-facing height and weight. This car seat can remain rear-facing up to 50 lb (22.5 kg) (do not install with LATCH for a child greater than 45 lb (20 kg))

**! WARNING!**



**NEVER** place this child restraint rear-facing in a vehicle seating location that has an active front air bag.

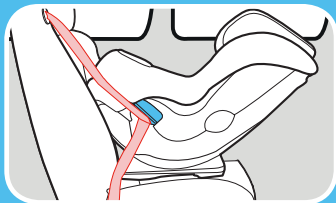

**Vehicle Seat Lap/Shoulder Belt**

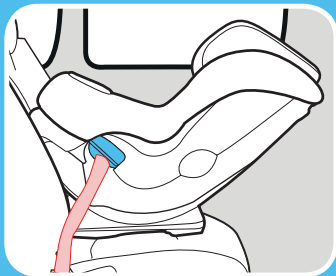

**Vehicle Seat Lap Belt**



**3 Rear Facing**

## When reading the level indicator,



3 Rear  
Facing

Vehicle **MUST** be on level ground.

Use corrected age for preemies.

- If the ball is entirely in light blue, the restraint is level for infants 0+ months in age.
- If the ball is in light blue and dark blue, the restraint is level for a child 3+ months in age.
- If the ball is in **RED**, child restraint is **NOT** level. You must adjust your recline position.



## 3-B Installing Rear-Facing With LATCH Straps

*Review your vehicle's owner manual for LATCH location and use. Do not install by this method for a child weighing more than 45 lb (20 kg)*

### 1. Store Top Tether Strap

Attach tether hook to the plastic bar on right side of the car seat.

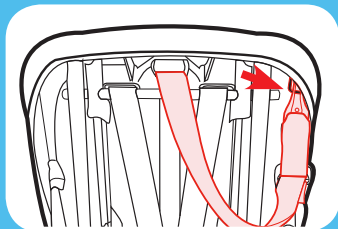

### 2. Remove LATCH Strap from Storage Location

Push in on the red buttons on the LATCH connectors and remove from storage position.

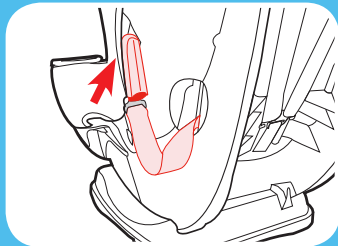



3 Rear  
Facing

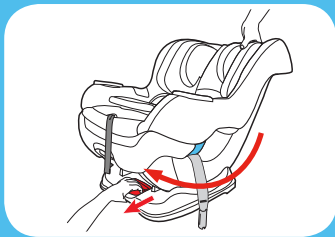
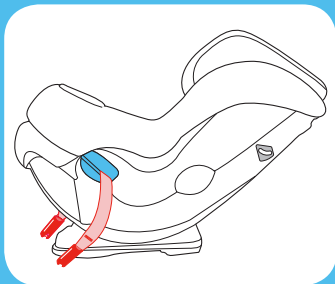

### 3. **Make Sure LATCH Strap is in the Rear-Facing Belt Path Marked With a Blue Label**

If not, See section 7 to move LATCH strap.

### 4. **Recline the Car Seat**

Pull out on handle on front of child restraint and adjust to one of the four rear-facing positions.

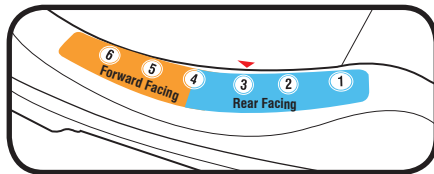

## 5. **Place Car Seat Rear-Facing in Back Seat of the Vehicle**

Place rear-facing in vehicle seat and center the car seat between the lower LATCH anchors. The base should sit as flat as possible on the vehicle seat.

## 6. **To Keep Your Child Rear Facing Longer**

For additional leg room squeeze the adjustment handle and pull the extender out. The extender has 4 positions.

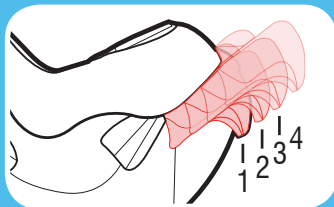
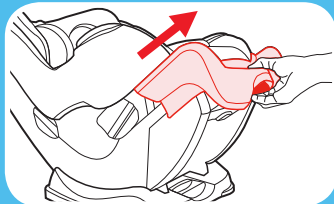
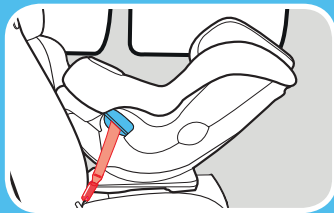

**3 Rear Facing**

3 Rear Facing

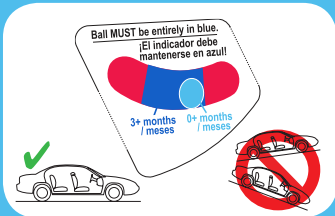
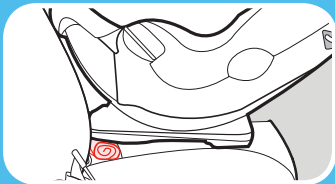
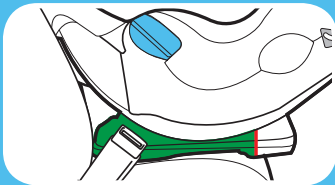

**7. Make Sure Base is a minimum of 80% on Vehicle Seat.**



**8. Check the Level Indicator**

Vehicle **MUST** be on level ground. **Ball must be completely in the blue zone.** Readjust the incline if needed. Or if needed, rolled towels may be placed under the car seat at the vehicle seat crease, until the ball is completely in the blue zone.

For infants 3 months and under, the **ball must completely cover** the light blue circle.

### 9. **Extend the LATCH Strap.**

For easier installation, extend the LATCH strap to its maximum length by pressing the grey button and pulling on the strap.

### 10. **Attach LATCH Connectors to Vehicle's Lower LATCH Anchors.**

LATCH strap should lie flat and not be twisted.

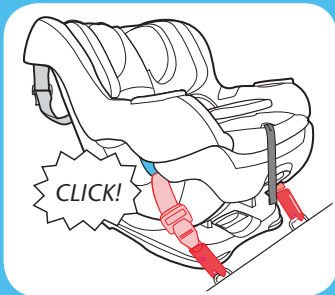
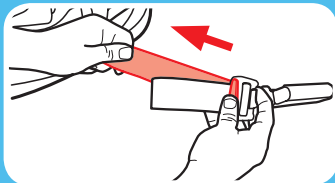
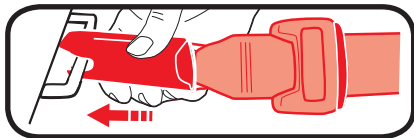

**3 Rear  
Facing**

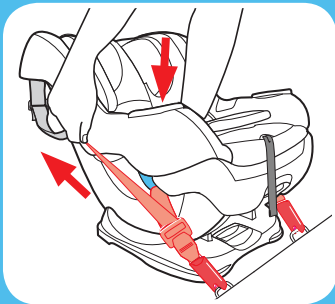

### 11. **Tighten the LATCH Strap**

Press down firmly in the center of the car seat while tightening the LATCH strap. You may need to tighten through the rear-facing belt path as shown.

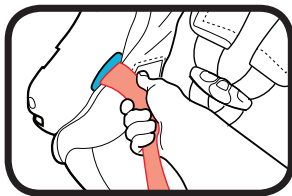

### 12. **Test For Tightness**

Grab the sides of the seat where the LATCH strap is and slide the car seat side-to-side and front-to-back.

If the seat moves less than 1" (2.5 cm), it is tight enough.

### 13. Check the Level Indicator

Vehicle **MUST** be on level ground.  
**Ball must be completely in the blue zone.** Readjust if needed.

For infants 3 months and under, the **ball must completely cover** the light blue circle.

If needed, rolled towels may be placed under the car seat at the vehicle seat crease, until the ball is completely in the blue zone.

**See section 5 to secure your child.**  
Recheck level indicator with child in seat.

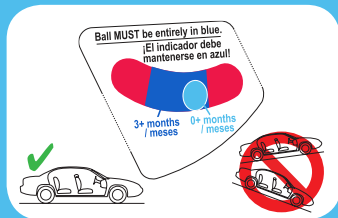

**3 Rear  
Facing**

## Is Everything Correct?

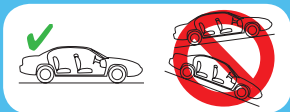

**Car Seat Does Not Move More than 1" (2.5 cm) at the Belt Path**

**Level Indicator's Ball in the Blue Zone and Vehicle on Level Ground**



**Harness Straps at or Just Below the Child's Shoulders.**

Review section 5

**Chest Clip Even With Armpits**

Review section 5

**Cannot Pinch Harness Straps at the Shoulder**

Review section 5



## 3-C Install Rear-Facing with Vehicle Seat Belt

### 1. Store Top Tether and LATCH Strap

Attach tether hook and LATCH connectors to the plastic bars as shown.

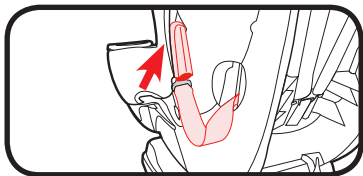

### 2. Recline the Car Seat

Pull out on handle on front of child restraint and adjust to one of the 4 rear-facing positions.

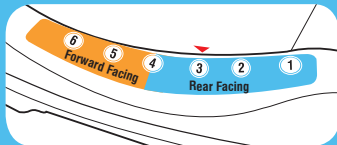
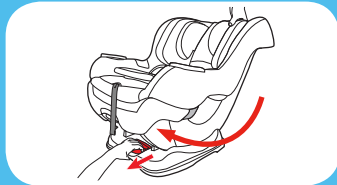
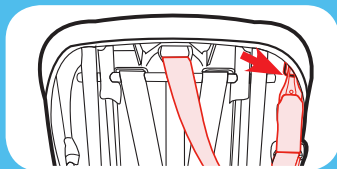

3 Rear Facing

**3 Rear Facing**

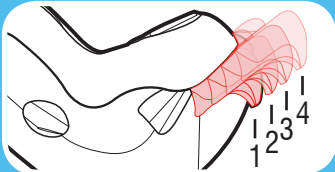
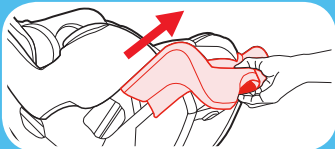
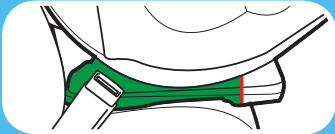
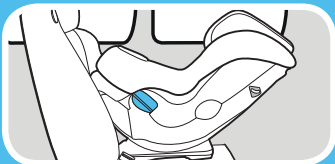

**3. Place Car Seat Rear-Facing in Back Seat of the Vehicle**

Place rear-facing in vehicle seat. The base should sit as flat as possible on the vehicle seat.

**4. Make Sure Base is a minimum of 80% on Vehicle Seat.**



**5. To Keep Your Child Rear Facing Longer**

For additional leg room squeeze the adjustment handle and pull the extender out. The extender has 4 positions.

## 6. Check the Level Indicator

Vehicle **MUST** be on level ground. **Ball must be completely in the blue zone.** Readjust if needed.

For infants 3 months and under, the **ball must completely cover** the light blue circle.

If needed, rolled towels may be placed under the car seat at the vehicle seat crease, until the ball is completely in the blue zone.

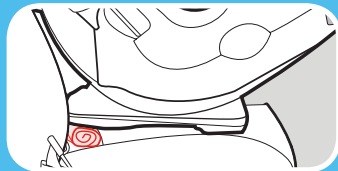
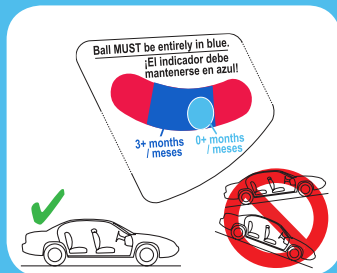

3 Rear  
Facing

## *Review your vehicle's owner manual for vehicle seat belt use*

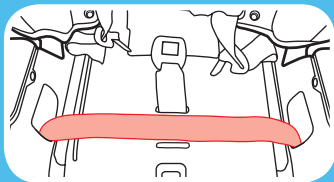
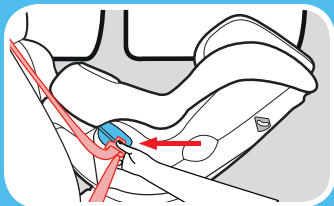

### **7. Route the Vehicle Seat Belt**

Thread vehicle seat belt through the rear-facing belt path (marked with a blue label) and out the other side. Buckle it. The seat belt should lie as flat as possible and not be twisted.

**Note:** It may be easier to route the vehicle seat belt by lifting seat pad up to expose the belt path.

Make sure the vehicle seat belt is in front of the buckle strap when the buckle is in the inner-most position, and in behind when in the outer-most position.



**3 Rear  
Facing**

## 8. **Lock Vehicle Seat Belt**

In most vehicles today, slowly pull the shoulder belt all the way out and then let it go back in. You will hear a clicking sound. Slowly pull out on the belt and it should be locked. If not, review your car's owner manual and section 8-D.

## 9. **Tighten the Vehicle Seat Belt**

Press down firmly in the center of the car seat. Pull on the shoulder belt to tighten while feeding the slack back in the retractor.

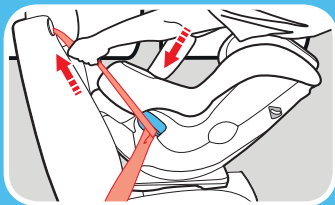
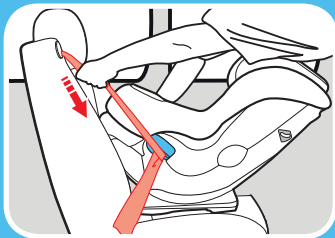

**3 Rear  
Facing**

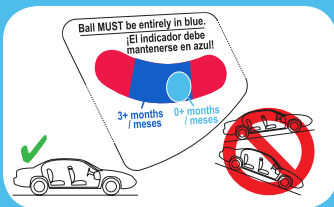
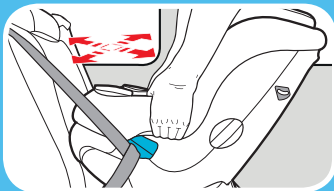

## 10. Test For Tightness

Grab the sides of the seat where the vehicle seat belt is and slide the car seat side-to-side and front-to-back.

If the seat moves less than 1" (2.5 cm), it is tight enough.

## 11. Check the Level Indicator

Vehicle **MUST** be on level ground. **Ball must be completely in the blue zone.** Readjust if needed.

For infants 3 months and under, the **ball must completely cover** the light blue circle.

If needed, rolled towels may be placed under the car seat at the vehicle seat crease, until the ball is completely in the blue zone.

**See section 5 to secure your child.**

Recheck level indicator with child in seat.

## Is Everything Correct?

**Car Seat Does Not Move More than 1" (2.5 cm) at the Belt Path**

**Level Indicator's Ball in the Blue Zone and Vehicle on Level Ground**



**Harness Straps at or Just Below the Child's Shoulders.**

Review section 5

**Chest Clip Even With Armpits**

Review section 5

**Cannot Pinch Harness Straps at the Shoulder**

Review section 5

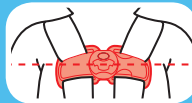
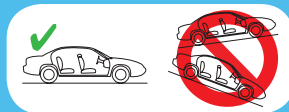

**3 Rear Facing**



## 4 Forward Facing

# 4-A Forward-Facing

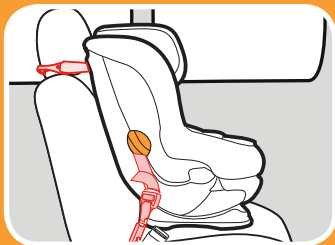

## LATCH Strap

**Do not install by this method for a child weighing more than 45 lb (20 kg)**

\*Check your state laws and the AAP/NHTSA recommendations.

**Forward-Facing:  
22-65 lb (10-30 kg) and  
49 inches (125 cm) or less  
and at least one year old\***

- The crotch strap must be in the front-most slot when forward facing.
- Place car seat forward-facing in the vehicle back seat.
- Make sure LATCH strap or vehicle seat belt is routed through the forward-facing belt path marked with a orange label.
- Install this car seat tightly in your vehicle. Car seat **should not move** at the forward-facing belt path more than 1". (2.5 cm) from side to side, front to back.



- Harness straps need to be **even with or just above** the top of child's shoulders and chest clip is at **armpit level**.
- **DO NOT USE** the leg extender forward-facing.
- The AAP recommends that children ride rear-facing until the age of 2 or until they reach the maximum rear-facing height or weight rating for their car seat. When forward-facing, children should use the built-in harness system for as long as possible until they reach the maximum forward-facing weight or height for their car seat. This car seat can remain rear-facing up to 50 lb (22.5 kg). (do not install with LATCH for a child greater than 45 lb (20 kg))

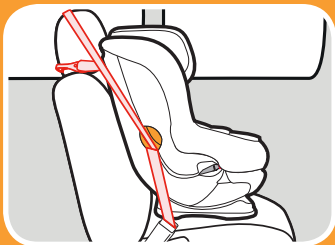

**Vehicle Lap/Shoulder Seat Belt**

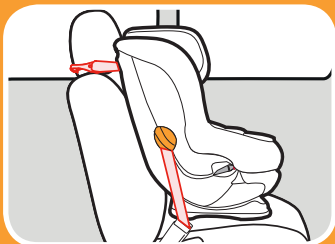

**Vehicle Seat Lap Belt**



**4 Forward Facing**



## 4 Forward Facing

# 4-B Install Forward-Facing with LATCH Straps

**Review your vehicle's owner manual for LATCH location and use. Do not install by this method for a child weighing more than 45 lb (20 kg)**

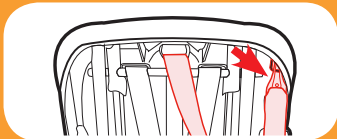
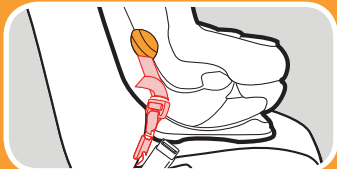
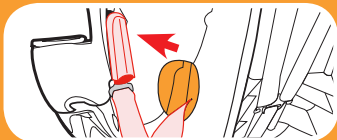

**1. Remove LATCH Strap from Storage Location**

**2. Make Sure LATCH Strap is in the Forward-Facing Belt Path Marked with Orange Label**

If not, See section 7 to move LATCH strap.

**3. Unhook Top Tether Strap From Storage**

Unhook tether and lay it in the seat.

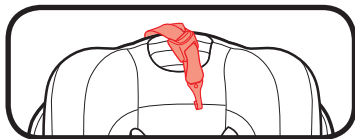

#### 4. **Adjust the Car Seat**

Place the car seat in the 4th, 5th or 6th recline position.

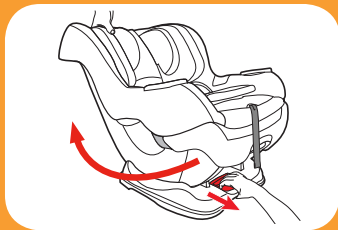

#### 5. **Place Car Seat Forward Facing in Back Seat of the Vehicle**

Place forward-facing in vehicle seat and center the car seat between the lower LATCH anchors. The base should sit as flat as possible on the vehicle seat.

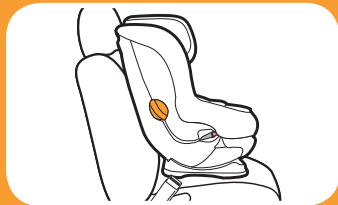

**4 Forward Facing**

4 Forward Facing

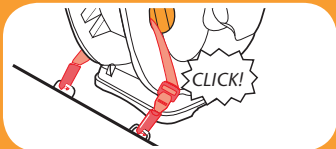
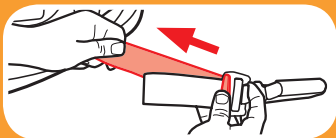
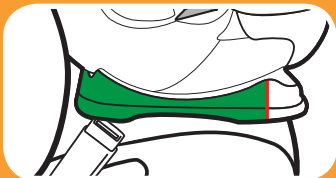

**6. Make Sure Base is a minimum 80% on Vehicle Seat.**



**7. Extend the LATCH Strap.**

For easier installation, extend the LATCH strap to its maximum length by pressing the grey button and pulling on the strap.

**8. Attach LATCH Connectors to Vehicle's Lower LATCH Anchors.**

LATCH strap should not be twisted.

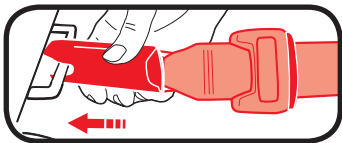

## 9. Tighten the LATCH Strap

Press down firmly in the center of the car seat while tightening the LATCH strap.

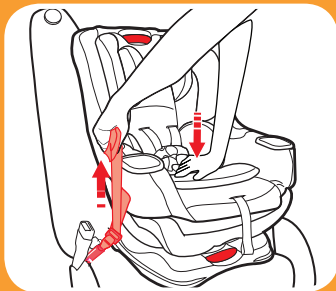

## 10. Attach The Tether

Extend the tether by pressing the grey button and pulling out on the strap and attach.

Consult vehicle's owner manual for specific location.

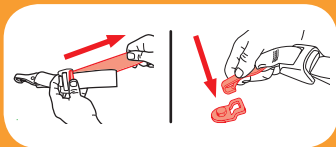

4 Forward Facing

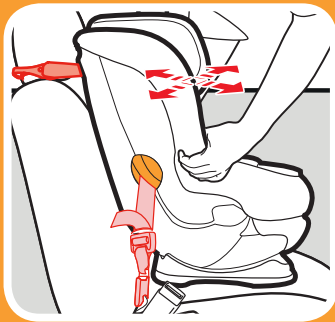
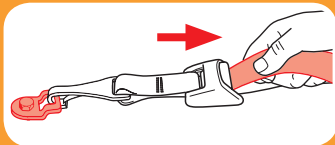

### **11. Tighten Top Tether Strap**

Push the car seat back while tightening the top tether strap to remove all the slack.

### **12. Test For Tightness**

Grab the sides of the seat where the LATCH strap is and slide the car seat side-to-side and front-to-back.

If the seat moves less than 1" (2.5 cm), it is tight enough.

**See section 5-A to secure your child.**

## ***Is Everything Correct?***

***Car Seat Does Not Move More than 1" (2.5 cm) at the Belt Path***

***Harness Straps at or Just Above the Child's Shoulders.***

Review section 5

***Chest Clip Even With Armpits***

Review section 5

***Cannot Pinch Harness Straps at the Shoulder***

Review section 5

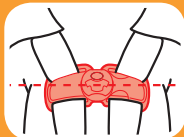

**4 Forward Facing**



## 4 Forward Facing

# 4-C Install Forward-Facing with Vehicle Seat Belt

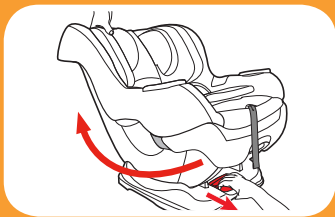
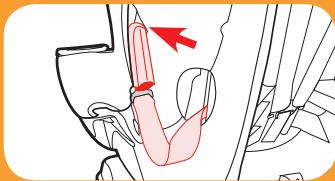

### 1. Store LATCH Strap

Attach LATCH connectors to the plastic bars as shown.

### 2. Adjust the Car Seat

Place the car seat in the 4th, 5th or 6th recline position.





### 3. **Unhook Top Tether Strap From Storage**

Unhook tether and lay it in the seat.

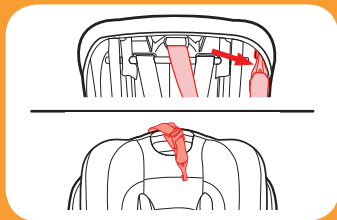

### 4. **Place Car Seat Forward-Facing in Back Seat of the Vehicle**

Place forward-facing in vehicle seat. The base should sit as flat as possible on the vehicle seat.



### 5. **Make Sure Base is a minimum of 80% on Vehicle Seat.**

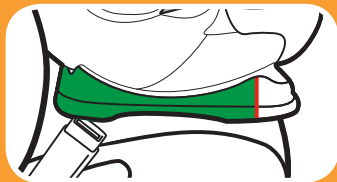

4 Forward Facing



## 4 Forward Facing

**Review your vehicle's owner manual for vehicle seat belt use**

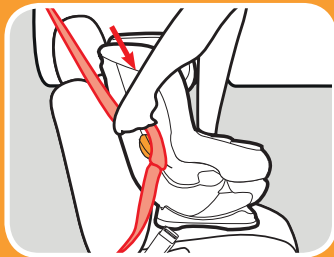
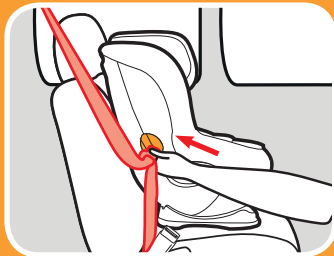

### **6. Route the Vehicle Seat Belt**

Thread vehicle seat belt through the forward-facing belt path (marked with a orange label) and out the other side. Buckle it. The seat belt should lie as flat as possible and not be twisted.

### **7. Lock the Vehicle Seat Belt**

In most vehicles today, slowly pull the shoulder belt all the way out and then let it go back in. You will hear a clicking sound. Slowly pull out on the belt and it should be locked. If not, review your car's owner manual and section 8-D.

## 8. **Tighten the Vehicle Seat Belt**

Press down firmly in the center of the car seat. Pull on the shoulder belt to tighten while feeding the slack back in the retractor.

## 9. **Attach The Tether**

Extend the tether by pressing the grey button and pulling out on the strap and attach. Consult vehicle's owner manual for specific location.

## 10. **Tighten the Top Tether Strap**

Push the car seat back while tightening the top tether strap to remove all the slack.

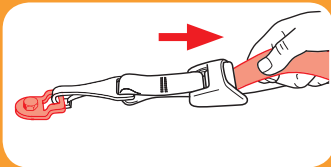
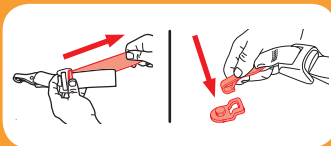

**4 Forward Facing**



## 4 Forward Facing



### 11. ***Test For Tightness***

Grab the sides of the seat where the vehicle seat belt is and slide the car seat side-to-side and front-to-back. If the seat moves less than 1" (2.5 cm), it is tight enough.

**See section 5-A to secure your child.**

## ***Is Everything Correct?***

***Car Seat Does Not Move More than 1" (2.5 cm) at the Belt Path***

***Harness Straps at or Just Above the Child's Shoulders.***

Review section 5

***Chest Clip Even With Armpits***

Review section 5

***Cannot Pinch Harness Straps at the Shoulder***

Review section 5

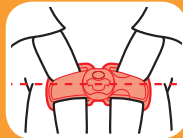

**4 Forward Facing**

## **! WARNING!**

**WARNING!** In cold weather, do not put snowsuits or bulky garments on your child when placing them in the car seat. Bulky clothing can prevent the harness straps from being tightened properly. To keep child warm, buckle your child in the car seat and place a blanket around the child or place the child's coat on backwards after buckling in.



### **5-A Securing Child 5-point Harness**

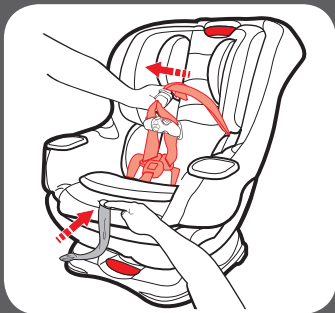

#### **1. Loosen Harness Straps**

Push down on the harness release lever while pulling out on the harness straps at the chest clip.

Unbuckle the chest clip and the crotch buckle. Place harness straps off to the sides.

Unbuckle the chest clip and the crotch buckle.

On select models, place harness straps in buckle storage pocket.

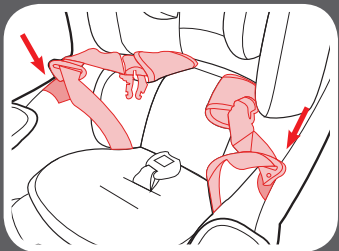
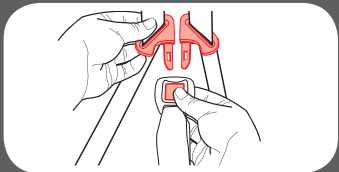
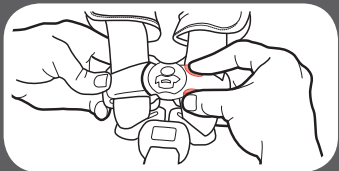

## 5 Securing Child



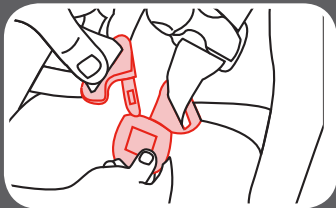
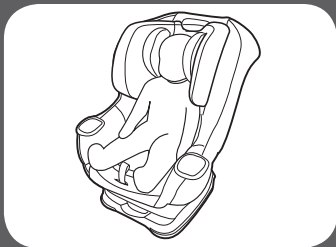

## **2. Place Your Child in the Seat**

Make sure their back is flat against the car seat back.

Avoid bulky or heavy clothing. Doing so will prevent the harness straps from being tightened properly. Place a blanket over the child after you have secured the child.

## **3. Place Harness Straps Over Child's Shoulders and Buckle**

You will hear a “click” when buckle tongues are securely attached. Pull up on each buckle tongue to make sure it is securely attached.



#### 4. **Be Sure the Harness Straps Are at the Proper Height**

**Rear-Facing:** Harness straps should be **at or just below** the child's shoulders. Top of head **must** be 1" (2.5 cm) below the headrest adjustment lever.

**Forward-Facing:** Harness straps should be **at or just above** the child's shoulders. Top of child's ears **below** top of headrest.



Rear-Facing



Forward-Facing



5 Securing  
Child



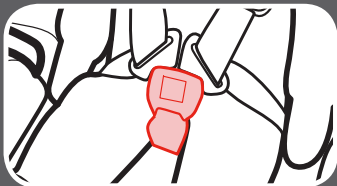
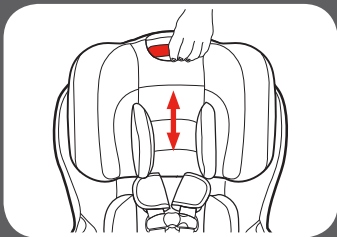

### **5. To Raise or Lower Headrest/ Harness Height**

Squeeze the adjustment handle and move headrest for the proper harness height.

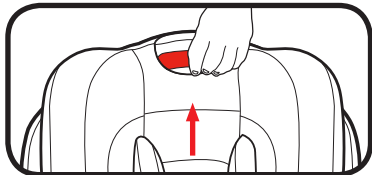

### **6. Check the Buckle Position**

The correct slot is the one that is closest to your child without being underneath them.

**The crotch strap must be in the front-most slot when forward facing.**

## 7. **To Adjust Crotch Strap**

Recline the car seat and locate the metal retainer under the car seat shell.

## 8. **Rotate Metal Retainer and Insert It Up Through the Shell and Pad**

From the top of the car seat, pull the crotch buckle out.

## 9. **Insert Metal Retainer in the New Crotch Buckle Slot**

Reach underneath the car seat and pull the metal retainer through. The crotch strap must be in the front-most slot when forward facing.

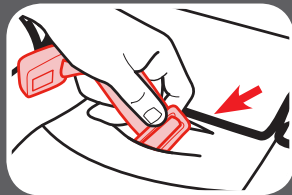
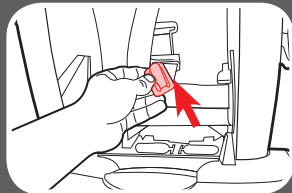
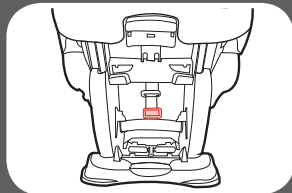

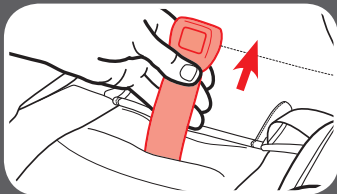

**10. Pull Up on Crotch Strap to Make Sure it is Secured**

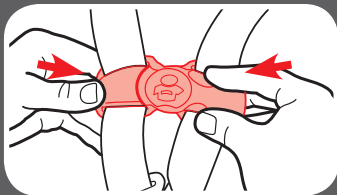

**11. Buckle the Chest Clip**

You will hear a “click” when the chest clip is securely buckled.

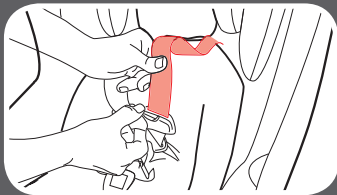

**12. Pull All the Slack Out From Around the Waist**

Pull up on the harness strap while pushing the chest clip down. Do this to both sides.

### **13. Tighten the Harness by Pulling the Harness Adjustment Strap**

When you are not able to pinch any of the harness webbing at your child's shoulder, the harness is tight enough.

A snug harness should not allow any slack. It lies in a relatively straight line without sagging. It does not press on the child's flesh or push the child's body into an unnatural position.

### **14. Raise the Chest Clip to Child's Armpit Level**

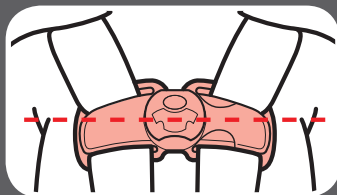
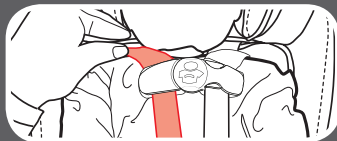
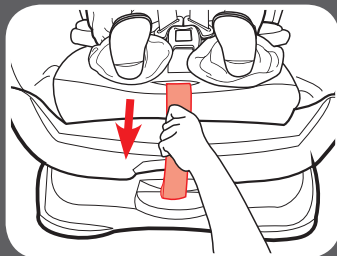

## 6-A Accessories *(on select models)*

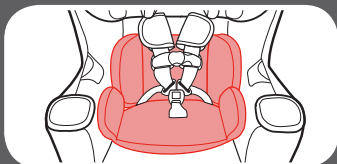
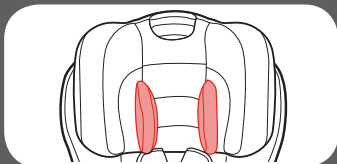
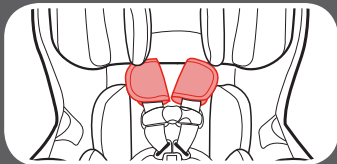

### ***Harness Covers***

Make sure that harness covers do not interfere with placement of the chest clip at armpit level. To remove, undo the fastening strips and remove.

### ***Head Support***

Slide head support into opening in headrest as shown. Curved bottom of head support allows for head support to be pulled down to fit smaller infants.

### ***Body Support***

**Use only in the rear-facing mode.**

Body support must be used if shoulders are below the lowest harness setting. Never allow body support to bunch or fold behind child.

## 7-A Moving the LATCH Strap

### 1. *For Ease of Moving the LATCH Strap*

- A. Undo Snaps and fastening strips in front of child restraint.
- B. Pull the LATCH straps out of the belt path opening, so that the LATCH hooks end up on the same side of the child restraint.

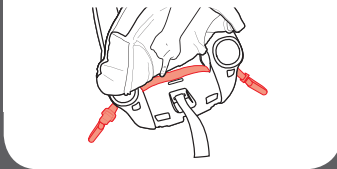
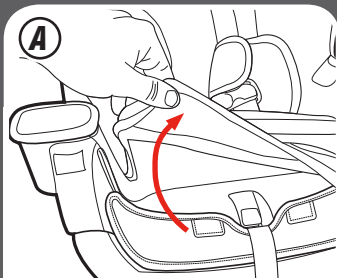
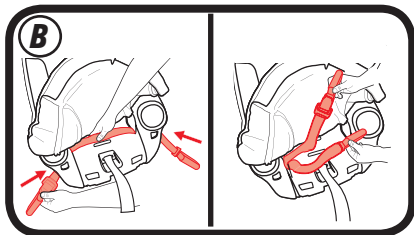

7 Moving  
LATCH

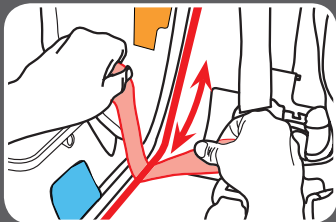

2. **Slide Entire LATCH Strap Along Bar to Correct Belt Path Opening**

**Rear-Facing:** Slide LATCH strap down to the blue label.

**Forward-Facing:** slide the LATCH strap up to the orange label.

3. **Feed the LATCH Connector with the Adjuster Closest to it Through the Chosen Belt Path**

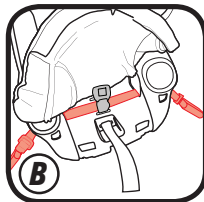
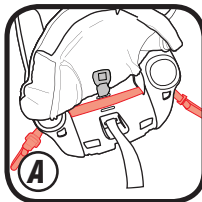
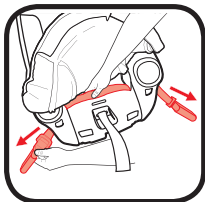
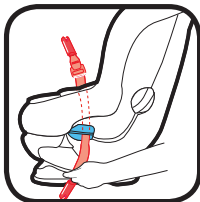

**Rear-Facing:** Make sure the LATCH strap is in front of the buckle strap when the buckle is in the inner-most position (A), and in behind when in the outter-most position (B) and that it is flat and is not twisted.



**Forward-Facing:** Make sure the strap is flat and not twisted.

**4. Replace the Seat Pad Fabric on the Front of the Child Restraint.**

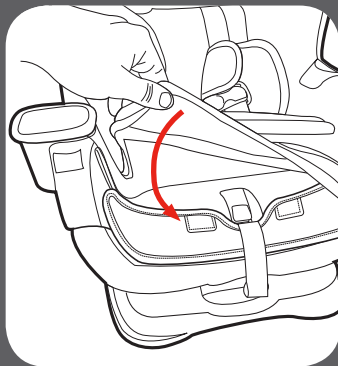
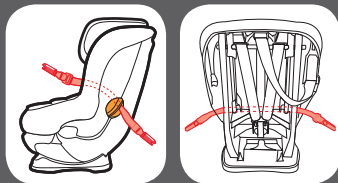

7 Moving  
LATCH

## 8-A How to Remove LATCH and Top Tether

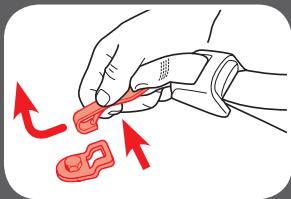
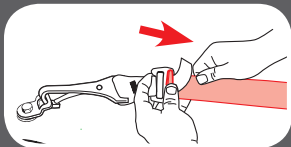

### **LATCH**

To remove the LATCH from the lower anchors, push in on the red buttons and pull them off.

### **Top Tether**

To remove, press the grey button and pull out on the strap to release the tension. Press in on the hook's spring. Push tether hook in, then lift up and pull away from tether anchor.

## 8-B Choosing Vehicle Seat Location

*Review your vehicle owner's manual for seating locations.*

***The best seating location for this car seat is one that:***

- Is recommended by your vehicle owner's manual, and
- Results in a secure installation of this car seat

In the event there is no available back seat and / or you have no other option than to place a child in a front passenger seating position (other than rear-facing), the National Highway Traffic Safety Administration (NHTSA) recommends that you take the following steps:

- Ensure the child is properly restrained according to their age and size
- Move the seat as far back as possible
- Make sure the child is not leaning out of position, such as leaning forward into the deployment path of the air bag
- Set the air bag ON-OFF switch, if available, to the OFF position



## 8-C Unsafe Vehicle Seat Locations

Never install this car seat in any of the following vehicle seating locations:



rear-facing or side-facing  
vehicle seats



rear-facing with an active  
front air bag

## 8-D Vehicle Seat Belts

*Review your vehicle owner's manual for vehicle seat belt use*

This car seat can be installed using a vehicle seat belt. To do this, you will need to change the seat belt to a locked mode for use with car seats. With some vehicle seat belts, this is done with the latchplate; with other vehicle seat belts, this is done with the retractor.

### *Vehicle Seat Belt Terms*

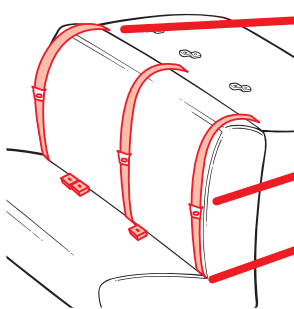

#### **Retractor**

A device that winds up the unused vehicle seat belt. It is often hidden inside the panels on the walls of the vehicle or in the vehicle seatback.

#### **Latch Plate**

The male end of the seat belt with the silver tongue.

#### **Seat Bight**

The crease where the vehicle seat back and seat bottom meet.

## Identify Your Seat Belt Type

There are two different types of vehicle seat belts that can be used with this car seat:

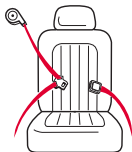

**Lap/Shoulder Belt**  
3 connection points. Can be used in all car seats modes of use.

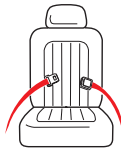

**Lap Belt Only**  
2 connection points.

The following types of vehicle seat belts **CANNOT** be used safely with this car seat:



Lap Belt with Motorized  
Shoulder Belt



Lap Belt or Shoulder Belt  
Mounted on Door



Belts Forward of the Seat  
Bight

## Lap/Shoulder Belt Installation - Rear-Facing/Forward Facing Modes

**Always review your vehicle owner's manual for specific information about your vehicle seat belts.**

There are three types of retractors: **ELR (Emergency Locking Retractor)**, **ALR (Automatic Locking Retractor)**, and **Switchable (ELR switch to ALR)**. To determine your type of retractor, follow these steps:

1. **Slowly** pull the belt out about halfway and stop.
2. Let the belt retract back several inches.
3. Try to **slowly** pull the belt out more. If the belt cannot be pulled any further, it is **ALR**. If it can be pulled further, go to the next step.
4. **Slowly** pull the belt all the way out, and then allow it to retract several inches.
5. Try to pull the belt all the way out again. If it cannot be pulled out, it is **Switchable**. If it can still be pulled out freely, it is **ELR**.

**Note:** Most vehicles manufactured after 1996 will have Switchable retractors in the back seat. If you have any questions about your retractor type, consult your vehicle owner's manual or call Graco for assistance.

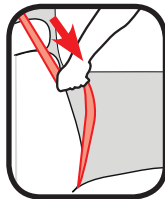

## How to Lock Your Lap and Shoulder Vehicle Seat Belt

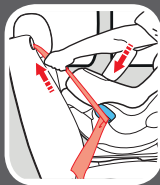
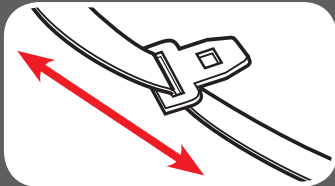

### Sliding Latch Plate and Switchable Retractor

A latchplate that slides freely on the belt webbing and cannot, by itself, hold the belt snug around a car seat.

When installing the car seat, route the vehicle seat belt through the proper belt path and buckle it in. **Slowly pull the shoulder belt all the way out to switch it to locking mode.** Then, as you pull the vehicle seat belt tight, feed all the slack back into the retractor.

Grab the sides of the seat at the belt path and slide the seat side-to-side and front-to-back. The seat should not move more than 1" (2.5 cm).

**Note:** With the vehicle seat belt in this locking mode, all the tension is upwards in the shoulder belt. This may start to tilt your car seat sideways. If this happens, use a locking clip instead of this switching the retractor. See Sliding Latch Plate and ELR Retractor.



### **Locking Latchplate and ELR Retractor**

A latchplate that holds the lap belt snug after it has been adjusted; contains a metal bar on the underside of the hardware that “locks” the belt in position.

When installing the car seat, route the vehicle seat belt through the proper belt path and buckle it in. Then, pull upwards on the shoulder belt so that the lap belt gets tight around the car seat.

Grab the sides of the seat at the belt path and slide the seat side-to-side and front-to-back. The seat should not move more than 1” (2.5 cm).

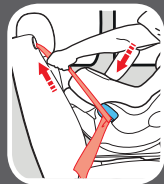
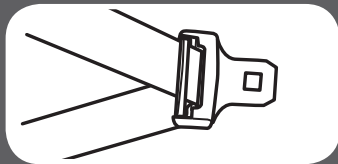

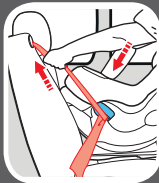
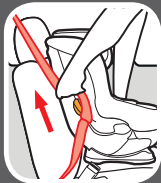
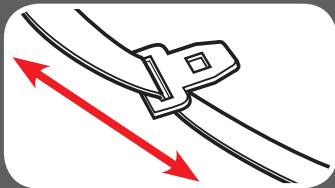

### ***Sliding Latch Plate and ALR Retractor***

A latchplate that slides freely on the belt webbing and cannot, by itself, hold the belt snug around a car seat.

**Slowly pull the shoulder belt all the way out.** Route the vehicle seat belt through the proper belt path and buckle it in. Then, as you pull the vehicle seat belt tight, feed all the slack back into the retractor.

Grab the sides of the seat at the belt path and slide the seat side-to-side and front-to-back. The seat should not move more than 1 inch (2.5 cm).

### **Sliding Latch Plate and ELR Retractor**

A latchplate that slides freely on the belt webbing and cannot, by itself, hold the belt snug around a car seat.

With this retractor, you will need to use the locking clip to lock the vehicle seat belt.

To get a locking clip order online at [gracobaby.com](http://gracobaby.com) or call 1-800 345-4109

Route the vehicle seat belt through the proper belt path and buckle it in. Pull the vehicle seat belt tight. While pushing down on seat, pinch the two straps together behind the buckle tongue. Unbuckle the belt without allowing it to slip.

Attach locking clip to lap and shoulder belts as shown.

Rebuckle belt. Check that lap belt does not move by pulling hard. If belt loosens or lengthens, repeat procedure.



**Locking Clip**

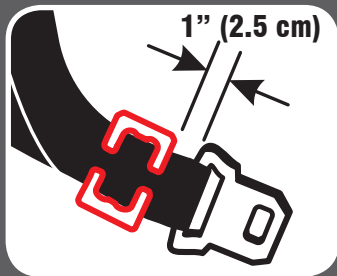

## Lap Belt Installation

**Always review your vehicle owner's manual for specific information about your vehicle seat belts.**



Grab the sides of the seat at the belt path and slide the seat side-to-side and front-to-back. The seat should not move more than 1 inch (2.5 cm).

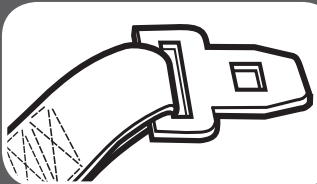

### **Locking Latch Plate and No Retractor**

When installing the car seat, route the lap seat belt through the proper path and buckle it in. Then, pull upwards on the tail of the belt so that the lap belt gets tight around the car seat.

### **Sewn On Latch Plate and ALR**

**Slowly pull the lap belt all the way out.** Route the vehicle seat lap belt through the proper belt path and buckle it in. Then, pull the lap belt tight while feeding all the slack back into the retractor.

## 9-A Cleaning Seat Pad

Clean with a damp sponge using mild soap and cool water. Refer to seat pad care tag for washing instructions.

Your model determines how to remove the seat pad. Follow the instructions that match your seat.

### **Seat Pad** (on most models)

Raise the headrest all the way up.

Lift up on the harness release lever while pulling out on the harness straps.

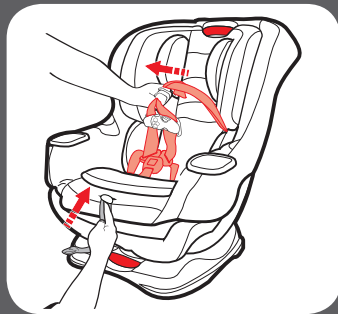
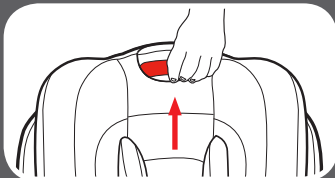

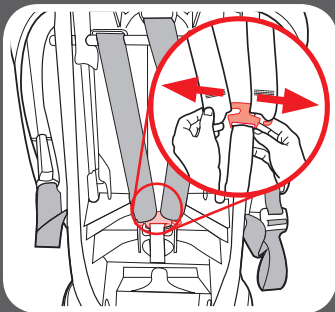
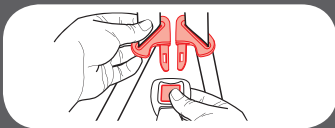
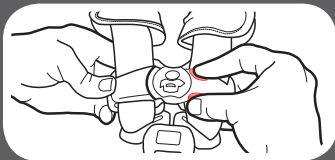

Unbuckle the chest clip and the buckle strap.

Face the rear of the seat and remove the belt straps from splitter plate as shown.

Grab hold of the shoulder straps and pull them out of their slots on the seat pad.

From the back of the seat, undo the elastic straps.

Undo both elastic straps from the sides of the seat.

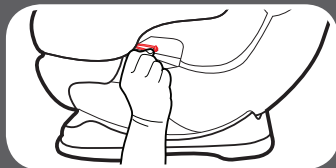
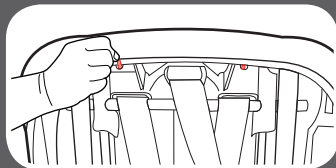
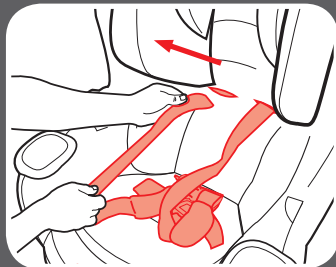

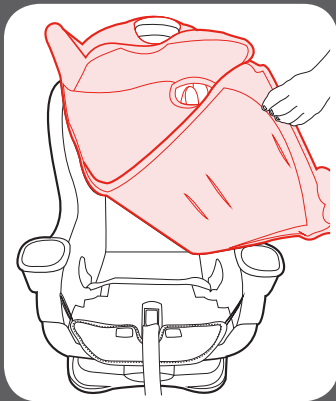

Remove pad from shell.

Machine wash pad in cold water on delicate cycle and drip-dry. **DO NOT USE BLEACH.**

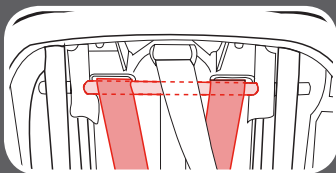

To put the seat pad back on, reverse preceding steps. Make sure that you rethread the harness straps **OVER THE METAL BAR**. The harness straps **MUST** not be twisted.



**Seat Pad** (on Rapid Remove™ models)

With the Rapid Remove™ seat pad, you do not need to uninstall the car seat to clean the seat pad.

Raise headrest all the way up.

From behind the seat undo the fastening strips.

From the front, undo the two seat snaps.

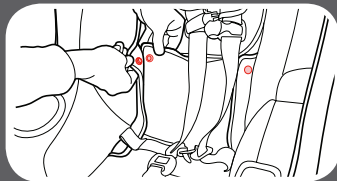
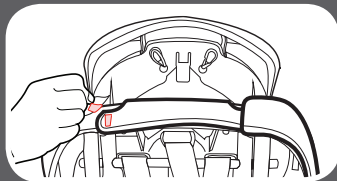
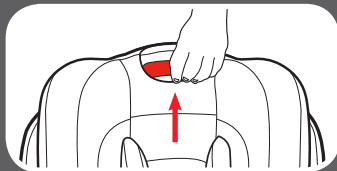

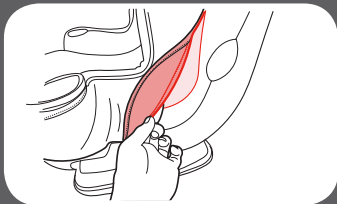

Pull side panel pocket off of side panel.

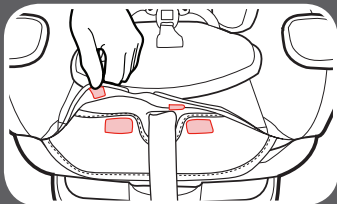

Undo fastening strips on the front of the seat

Remove pad from shell.

Machine wash pad in cold water on delicate cycle and drip-dry. **DO NOT USE BLEACH.**

To put the seat pad back on, reverse preceding steps.

### **Rear Pad**

You may need to uninstall the car seat to remove the pad.

Undo elastic loops and remove.

To reattach rear pad:

**1.** Lower the headrest.

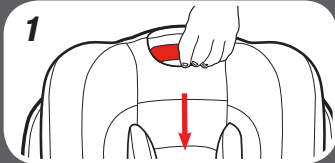
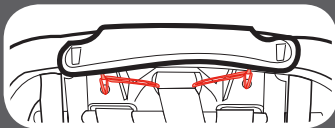
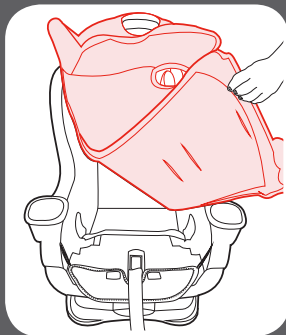

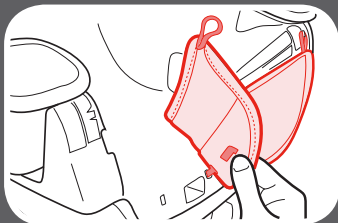
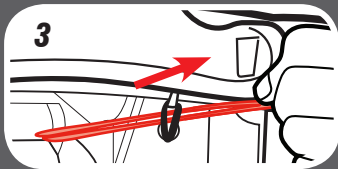
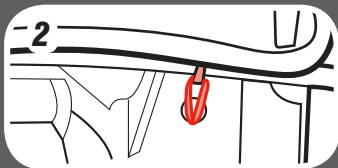

2. Attach the shorter loop first.
3. Pull the longer loop behind the shorter loop.
4. Wrap the Longer loop around the shorter loop one time and attach to the hook.

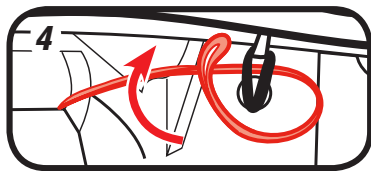

### **Front Pad**

You may need to uninstall the car seat to remove the pad.

Undo the elastic loops on top of the front pad, then undo the pins by pulling the pad away from the seat.

To put the front pad back on, reverse preceding steps.

## **Head Support Cover**

Undo elastic loop underneath head support cover. Pull tab out from behind head support.

Undo the elastic loops on the sides of the headrest.

Peel cover off head support.

Machine wash pad in cold water on delicate cycle and drip-dry. **DO NOT USE BLEACH.**

To put the head support cover back on, reverse preceding steps.

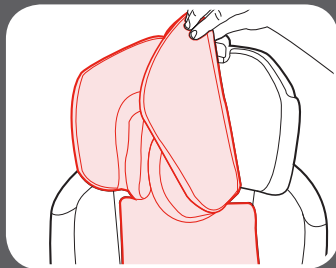
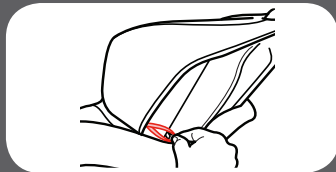
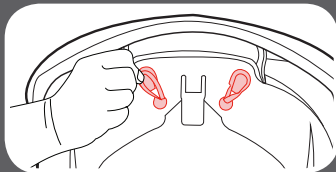

## 9-B Cleaning Crotch Buckle



Recline the car seat and locate the metal retainer. Rotate the metal retainer up through the shell and pad. From the front, pull the crotch buckle out.

To clean buckle, place in a cup of warm water and gently agitate the buckle. Press the red button several times while in the water.

**DO NOT SUBMERGE THE BUCKLE STRAP.** DO NOT USE SOAPS, HOUSEHOLD DETERGENTS or LUBRICANTS.

Shake out excess water and allow to air dry. Repeat steps as needed until it fastens with a click. Re-insert the buckle into the same slot it was removed. Pull on crotch buckle to make sure it is secured.

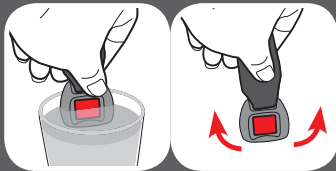

**WARNING!** Inspect and clean buckle from time to time to remove any objects or debris that could prevent latching.

## 9-C Cleaning Harness and LATCH Straps

Surface wash only with mild soap and damp cloth. **DO NOT IMMERSE THE HARNESS STRAPS or LATCH STRAP IN WATER** Doing so may weaken the straps. If harness straps or LATCH belt are frayed or heavily soiled, contact Customer Service at [www.gracobaby.com](http://www.gracobaby.com) or 1-800-345-4109.

## Replacement Parts

To purchase parts or accessories in the United States, please contact us at the following:

**[www.gracobaby.com](http://www.gracobaby.com)**

**or**

**1-800-345-4109**

---

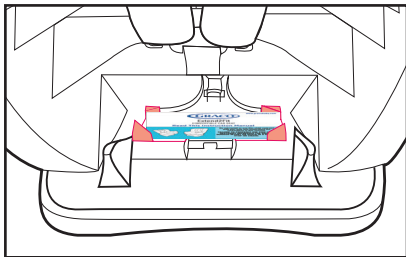

Store instruction manual behind the tab with the instruction book icon as shown.