

PD349562D 10/16



www.gracobaby.com

4EVER™ featuring



4-IN-1 CAR SEAT

Read This Instruction Manual

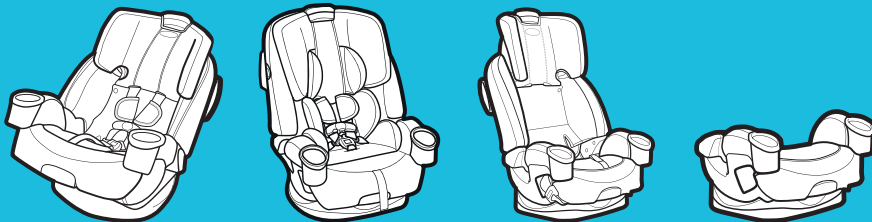

Do not install or use this child restraint until you read and understand the instructions in this manual.

FAILURE TO PROPERLY USE THIS CHILD RESTRAINT INCREASES THE RISK OF SERIOUS INJURY OR DEATH IN A SUDDEN STOP OR CRASH.

1 Important

Pages 6-27

1-A Quick Guide to Your Manual

1-B Welcome to the Graco Family

1-C Right Mode of Use

1-D Before You Begin

Register This Car Seat

If You Need Help

Certification

Car Seat's Useful Life

Vehicle Seat Protection

Warm Weather Use

1-E Safety Warnings

2 Features

Pages 28-33

3 Rear-Facing

Pages 34-46

3-A Rear-Facing Use

3-B Install Rear-Facing with LATCH Straps

3-C Install Rear-Facing with Vehicle Seat Belt

4 Forward-Facing

Pages 47-64

4-A Forward-Facing Use

4-B Install Forward-Facing with LATCH Straps

4-C Install Forward-Facing with the Vehicle Seat Belt

5 Booster

Pages 65-80

- 5-A Booster Use**
- 5-B Install Backed Booster**
- 5-C Install Backless Booster**

6 Securing Child

Pages 81-97

- 6-A Securing Child 5-Point Harness**
- 6-B Securing Child Backed Booster**
- 6-C Securing Child Backless Booster**

7 Moving the LATCH Strap

Pages 98-101

8 Accessories

Page 102

9 Vehicle Information

Pages 103-113

9-A How to Remove LATCH and Top Tether

9-B Choosing Vehicle Seat Location

9-C Unsafe Vehicle Seat Location

9-D Vehicle Seat Belts

10 Care & Cleaning

Pages 114-117

10-A Cleaning Seat Pad

10-B Cleaning Buckle Strap

10-C Cleaning Harness and LATCH Straps

1-A Quick Guide to Your Manual

This car seat is for children: **Rear-Facing: 4-40 lb (1.8-18 kg)**
Forward-Facing: 22-65 lb (10-30 kg)
Backed Booster: 40-100 lb (18.1-45 kg)
Backless Booster: 40-120 lb (18.1-54 kg)

- Infants who weigh less than 22 lb (10 kg) **MUST be rear-facing**. Review section 1-C for more information.

Note: Preterm or low birth weight infants may be at special risk in a vehicle or aircraft. According to the AAP, these infants may suffer breathing issues if improperly reclined in a car seat. When rear-facing, use the corrected age for preemies. Graco advises that you have your physician or hospital staff evaluate your infant and recommend the proper car seat or car bed before you and your infant leave the hospital.

Install Cup Holders

Cup holders must be installed.

To attach the cup holders, match the right cup holder (find the letter R on the bottom of the cup holder) to the right side of the seat and the left "L" to the left.

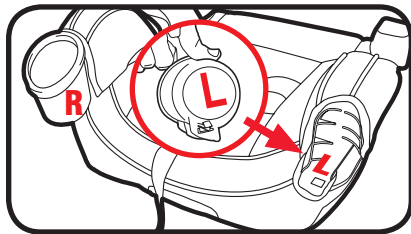

Move the fabric aside and align the tab behind the cup holder with the slot in the seat.



Align the tab on the bottom of the cup holder with the hole in the seat.

Use both hands to push down hard on the cup holder. **You will hear a “Click” when they are secured in place.**

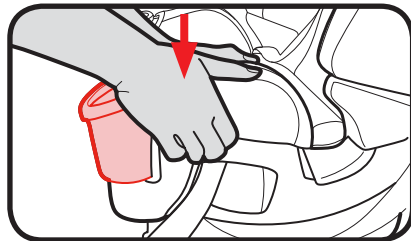
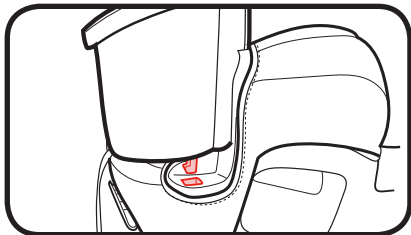
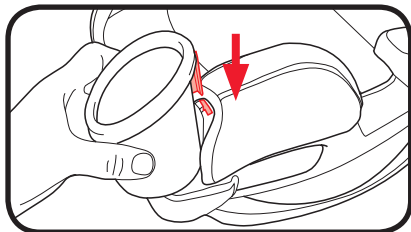

i 1 Important

Get to Know Your Car Seat

Review section 2-A to see all of the features of this car seat.

What Seating Location Should I Use?

The best seating location for this car seat is one that:

- Is recommended by your vehicle owner's manual, and
- Results in a secure installation of this car seat.

Some vehicles have specific requirements for where the car seat can be installed, so be sure to check your vehicle owner's manual for available seating positions, if any. For example, sometimes the center rear seat has a lap belt only vehicle seat belt, which cannot be used when this car seat is in Booster mode.

Review section 9-C, 9-D of this manual AND your vehicle owner's manual.

WARNING!



NEVER place this child restraint rear-facing in a vehicle seating location that has an active front air bag.

In the event there is no back seat, review your vehicle owner's manual to see how to use your child restraint.

According to crash statistics, the safest place for your child in any vehicle is the back seat. The center of the back seat can be the safest during a possible side impact.



Which Installation Method Should I Use?

This car seat can be installed in your vehicle using either the vehicle seat belt **OR** the LATCH system. Both are equally safe to use. **DO NOT USE BOTH AT THE SAME TIME.**

Vehicle Seat Belt: Review section 9 and your vehicle owner's manual to learn how to install your car seat with the vehicle seat belts.

LATCH: The LATCH system allows you to securely attach your safety seat in your car without using the vehicle seat belt and possibly to get a better fit. All 2003 and newer model year vehicles are required to have a LATCH system, although some manufacturers began including LATCH earlier. Some vehicle owner manuals use the term ISOFIX to identify the LATCH system.



1 Important

What is LATCH?

LATCH consists of lower anchors and top tether anchors, which are built-in to your vehicle, and connecting hooks that are built-in to your car seat. Lower anchors are used **INSTEAD** of the vehicle's seat belt to secure the child seat to the vehicle. Top tethers are used **IN ADDITION** to the lower anchors **OR** the vehicle's seat belt to secure a forward-facing car seat to the vehicle.

Review your vehicle's owner manual for exact location and use.

**Vehicle Top Tether
Anchor Points**

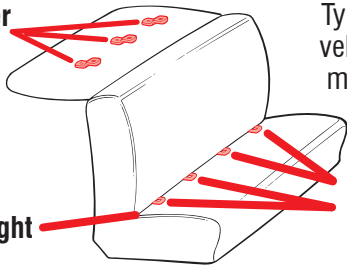

Typical seat in a passenger vehicle. Other vehicle types may have different LATCH locations.

Vehicle Seat Belt

**Vehicle Lower
Anchor Points**



When Installing Rear-Facing or Forward-Facing

LATCH System

LATCH consists of lower anchors, which are built-in to your vehicle, and connecting hooks that are built-in your car seat.

Review section 3-B, 4-B of this manual AND your vehicle owner's manual before installing.

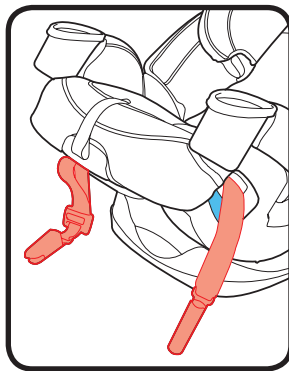
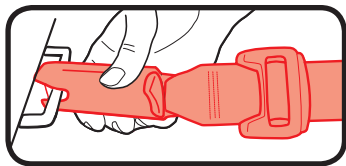

Vehicle Seat Belt

There are two types of vehicle seat belts that can be used. Lap/Shoulder Seat Belt or Lap Only Seat Belt.

Review section 3-C, 4-C and 9 of this manual AND your vehicle owner's manual before installing.

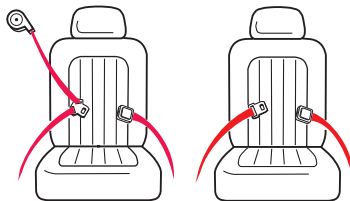

When Installing As a Booster

Vehicle Seat Belt

Only use the Lap/Shoulder seat belt configuration.

Review section 5-B, 5-C of this manual AND your vehicle owner's manual.

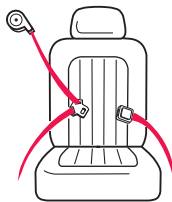

Does Your Car Seat Fit Your Child Correctly?

To make sure your child is secured properly, review section 3,4 and 5 to understand all of the actions you need to take to properly adjust the car seat to fit your child.

i
1 Important

For Rear-Facing and Forward-Facing, You Need to Adjust:

Harness Height, Rear-Facing (A)

Harness straps at or just below the child's shoulders. Review section 6.

Harness Height, Forward-Facing (B)

Harness straps at or just above the child's shoulders. Top of child's ears below top of headrest **(C)**. Review section 6.

Buckle Position (D)

The correct slot is the one that is closest to your child without being underneath them. Review section 6.

Harness Tightness (E)

If your fingers slide off the harness straps without pinching the straps, it is tight enough. Review section 6.

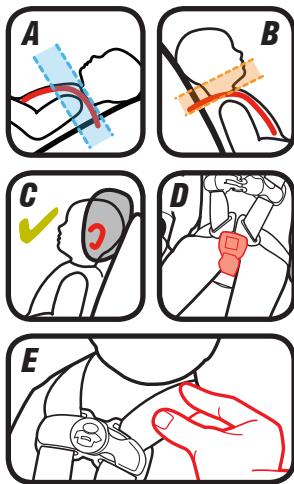

For Booster, You Need to Adjust:

Use Lap/Shoulder Belt Only



Position Lap Belt

Lap belt must go behind armrest and lie low across your child's hips and thighs.



Position Shoulder Belt

Shoulder belt lies across shoulder between neck and edge of shoulder.

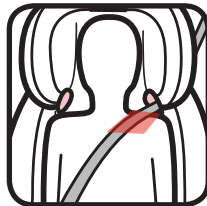

Did You Do Everything Correctly?

Rear-Facing

Car Seat Does Not Move More than 1" (2.5 cm) at the Belt Path (A)

Review section 3

Level Indicator's Bubble in the Blue Zone (B)

Review section 3

Harness Straps at or Just Below the Child's Shoulders (C)

Review section 6.

Chest Clip Even With Armpits (D)

Review section 6

Cannot Pinch Harness Straps at the Shoulder (E)

Review section 6

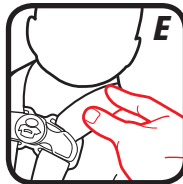
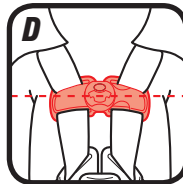
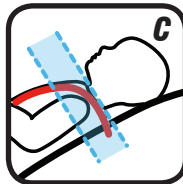
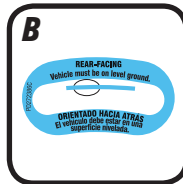
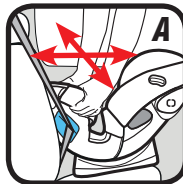

i
1 Important

Forward-Facing

Use the top tether strap when using forward-facing (A)

When used properly, the top tether helps reduce injury in a sudden stop or crash.

Review section 4

Car Seat Does Not Move More than 1" (2.5 cm) at the Belt Path (B)

Review section 4

Harness Straps at or Just Above Child's Shoulders (C)

Review section 6

Chest Clip Even With Armpits (D)

Review section 6

Cannot Pinch Harness Straps at the Shoulder (E)

Review section 6

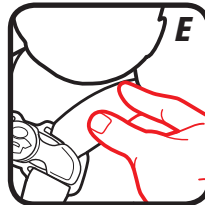
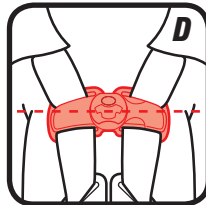
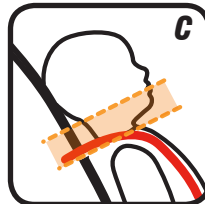
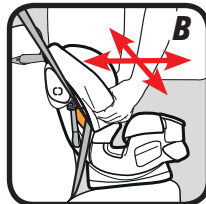
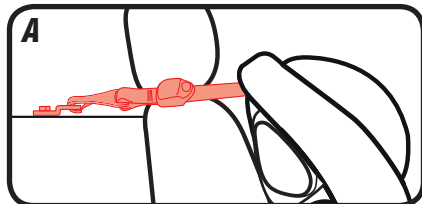

Booster

Never Use Lap Belt Only

Review section 6



Lap Belt Behind Armrest and Lies Low Across Hips and Thighs

Review section 6

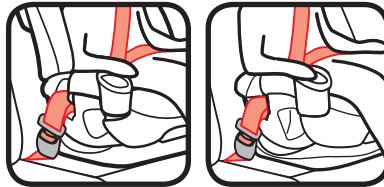

Shoulder Belt Lies On the Shoulder, Between the Neck and Edge of Shoulders

Review section 6

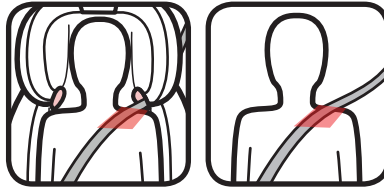

i 1 Important



1 Important

1-B Welcome to the Graco Family!

Your child's safety depends on you. No car seat can guarantee protection from injury in every situation, but proper use helps reduce the risk of serious injury or death.

Even if this car seat seems easy to figure out on your own, you must follow the detailed instructions in this instruction manual to ensure the steps below are performed correctly.

1-C Right Mode of Use



1 Important

4 lb (1.8 kg)	22 lb (10 kg)	40 lb (18 kg)	65 lb (30 kg)	120 lb (54 kg)
------------------	------------------	------------------	------------------	-------------------

Rear-Facing with 5-Point Harness

Must be 49" (125 cm) or less:

4-22 lb (1.8-10 kg) less than 1 year old **MUST** be rear-facing.

22-40 lb (10-18 kg) **SHOULD** be rear-facing.*

Forward-Facing with 5-Point Harness

Must be 49" (125 cm) or less:

22-40 lb (10-18 kg) can sit upright unassisted **CAN** be forward-facing.

40-65 lb (18-30 kg) **SHOULD** be forward-facing.*

Booster Mode with Vehicle Lap/Shoulder Seat Belt

Must be 43-57" (110.1-145 cm) tall and 4+ years old

40-65 lb (18.1-30 kg) **CAN** be in backed booster mode.

40-65 lb (18.1-30 kg) **CAN** be in backless booster

mode. Over 65 lb (30 kg) **MUST** be in booster mode.*

*Check your state laws and the AAP/NHTSA recommendations.

Review page 25 more for information.



1 Important

1-D Before You Begin

Register This Child Restraint

Please fill out the prepaid registration postcard attached to the harness and mail it in today **or register online at www.gracobaby.com/carseatregistration.**

Child restraints could be recalled for safety reasons. You must register this restraint to be reached in a recall. Send your name, address, and the restraint's model number and manufacturing date to:

Graco Children's Products, Inc.

Attn: Customer Service

P.O. Box 169, Elverson, PA 19520-9901

or call 1-800-345-4109

or register online at

www.gracobaby.com/carseatregistration

For recall information, call the U.S. Government's Vehicle Safety Hotline at 1-888-327-4236 (TTY: 1-800-424-9153), or go to <http://www.NHTSA.gov>.

For future reference or if you change addresses, record the model name, model number, date of manufacture and purchase date of this car seat on the below. You can find this information either on the registration card if you still have it or on the date label located on the back of the car seat.

Model Name _____

Model Number _____

Date of Manufacture _____

Date of Purchase _____

If You Need Help

In the U.S.A, please contact our Customer Service Department with any questions you may have concerning parts, use, or maintenance. When you contact us, please have your product's model number and date of manufacture ready so that we may help you efficiently. These numbers can be found on a sticker on the back side of your car seat.

For additional resources or to get your car seat checked by a child passenger safety technician, please visit the following web sites:

www.nhtsa.gov • www.seatcheck.org • www.safekids.org



1 Important

Certification

This child restraint meets or exceeds all applicable requirements of Federal motor vehicle safety standard 213 for use in motor vehicles.



This child restraint is certified for use in aircraft. Use only on forward-facing aircraft seats. Follow the instructions for vehicle installation. For rear-facing installation, see section 3-C and 9-D Lap Belt Installation. For forward-facing installation, see section 4-C and 9-D Lap Belt Installation, but do not use top tether.



This child restraint is NOT certified for use in aircraft when used as a booster seat because aircrafts do not have shoulder belts.

Contact the airline for their specific policies.

Car Seat's Useful Life

STOP using this car seat and throw it away 10 years after the date of manufacture. Look for this sticker on back of the car seat.

Graco Children's Products Inc. advises against loaning or passing along a car seat unless you know the complete history of the product. We also advise against purchasing a car seat second hand.



Vehicle Seat Protection

Protect vehicle seat. Use a car seat mat, towel, or thin blanket under and behind car seat.

Warm Weather Use

Car seat parts can get very hot in the sun or warm weather. **To avoid burns, always check before putting child in car seat.**

1-E Safety Warnings

No car seat can guarantee protection from injury in every situation, but proper use helps reduce the risk of serious injury or death. **READ THIS MANUAL CAREFULLY.**



1 Important

! WARNING!

Failure to follow these instructions and child restraint's labels can result in child striking the vehicle's interior during a sudden stop or crash.



! NEVER PLACE THIS CHILD RESTRAINT REAR-FACING IN A VEHICLE SEATING LOCATION THAT HAS AN ACTIVE FRONT AIR BAG.

If an air bag inflates, it can hit the child and car seat with great force and cause serious injury or death to your child.



1 Important

! Review your vehicle owner's manual for more information about air bags and car seat use.

! If your vehicle does not have a back seat, review your vehicle owner's manual.

! The American Academy of Pediatricians (AAP) and National Highway Safety Administration (NHTSA) recommend that children ride rear facing until the age of 2 or until they reach the maximum rear-facing height or weight rating for their seat, and when forward-facing, children should use the built-in harness system for as long as possible until they reach the maximum forward-facing weight or height for their car seat. After reaching the maximum forward-facing weight or height, they also recommend that children 4' 9" inches tall or under should ride in a belt-positioning booster seat.

! Choose the correct mode of use for the car seat depending on your child's size. Infants less than 22 lb (10 kg) MUST use this car seat rear-facing.

! Select a suitable location for the car seat in your vehicle.

! Secure car seat with a vehicle seat belt or LATCH that is properly routed as shown in this manual.



1 Important

! Vehicle seat belt system MUST hold car seat securely. Not all vehicle seat belts can be used with a car seat.

! If vehicle seat belt does not hold car seat securely, read “Vehicle Seat Belts” section 9-D and your vehicle owner’s manual.

! Always secure car seat with LATCH or a vehicle seat belt, even when unoccupied. In a crash, an unsecured car seat can injure passengers.

! If car seat is in a crash, it must be replaced. DO NOT use it again! A crash can cause unseen damage and using it again could result in serious injury or death.

! DO NOT use car seat if it is damaged or missing parts.

! DO NOT use accessories or parts other than those provided by Graco. Their use could alter the performance of the car seat.

! DO NOT remove LATCH system from car seat. If using vehicle seat belt to secure car seat, LATCH connectors must be stored.

! Never leave child unattended, even when sleeping. Child may become tangled in harness straps and suffocate or strangle.

! Rear-facing car seat must be properly leveled:

- Too reclined can result in injury or ejection.
- Too upright can result in breathing difficulties.



! Never attach two LATCH connectors to one vehicle lower anchor point unless specifically allowed by the vehicle manufacturer.

! Do not use both the vehicle belt and LATCH belts at the same time when using the car seat rear or forward facing.



1 Important

2-A Car Seat Features



2 Features

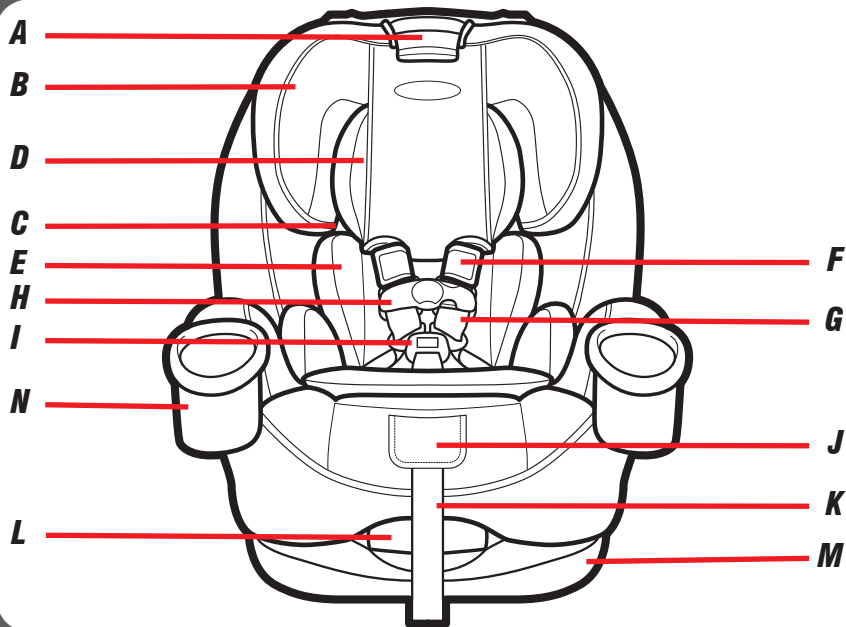

- A Headrest/Harness Adjustment Lever**
- B Headrest**
- C Booster Shoulder Belt Guide**
- D Headrest Infant Pillow**
- E Infant Body Pillow**
- F Harness Covers**
- G Harness Straps**
- H Chest Clip**
- I Buckle**
- J Harness Release Lever (under flap)**
- K Harness Adjustment Strap**
- L Recline Handle**
- M Seat Base**
- N Cup Holder**
- O Belt Lock-Off (under seat back pad)**

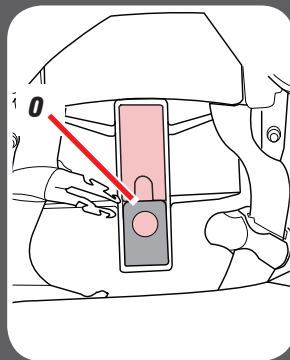



2 Features

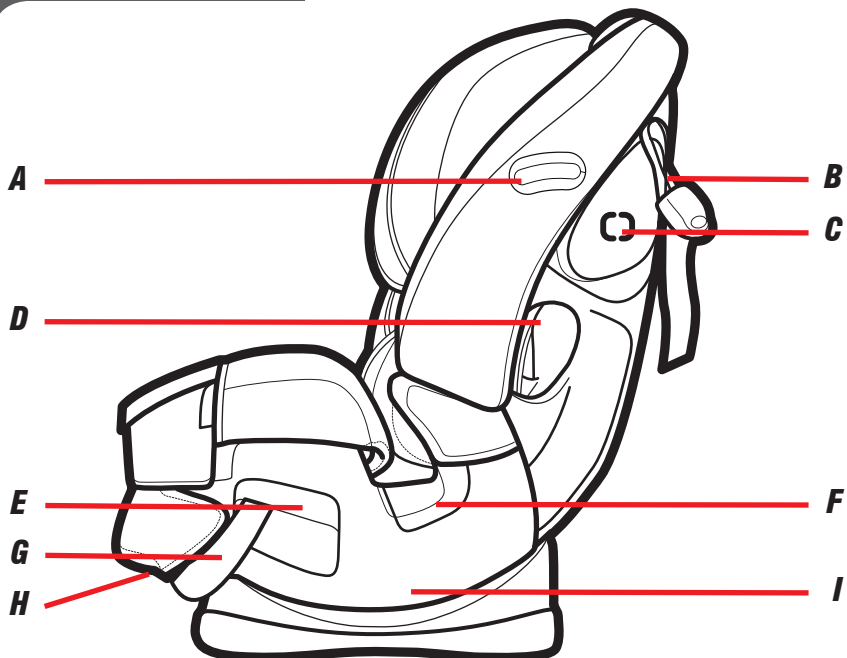

- A Level Indicator***
- B Top Tether Strap***
- C TrueShield Bolster***
- D Forward-Facing Belt Path***
- E Rear-Facing Belt Path***
- F Booster Lap Belt Path***
- G LATCH Strap***
- H Rear-Facing LATCH Strap
Storage (under seat)***

- I Recline Position Indicator***



2 Features



2 Features

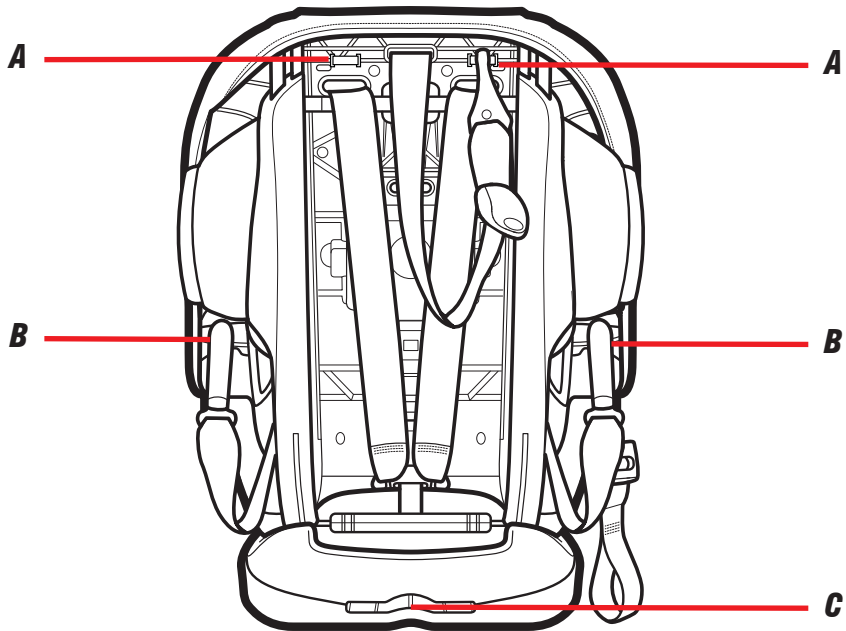

A Top Tether Strap Storage

***B Forward-Facing LATCH
Strap Storage***

C Instruction Manual Storage



2 Features

3-A Rear-Facing Use

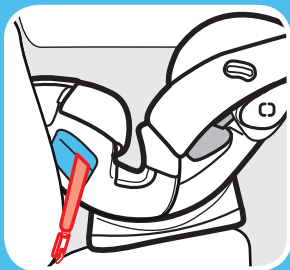

LATCH Strap

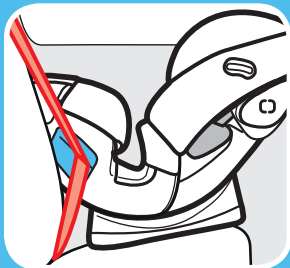

**Vehicle Seat Lap/
Shoulder Belt**

Rear-Facing:
4-40 lb (1.8-18 kg) and whose head is at least 1" (2.5 cm) below the headrest adjustment handle*

- Infants who weigh less than 22 lb (10 kg) **MUST be rear-facing.**
- Place car seat rear-facing in the vehicle back seat.
- Make sure LATCH strap or vehicle seat belt is routed through the rear-facing belt path marked with a blue label.
- Install this car seat tightly in your vehicle. Car seat **should not move** at the rear-facing belt path more than 1" (2.5 cm) from side to side, front to back.
- Check recline level making sure the bubble is within the blue area. Vehicle **MUST** be on level ground.



**3 Rear
Facing**

- Harness straps need to be **even with or just below** the top of child's shoulders and chest clip is at **armpit level**.
- Recheck the level indicator with child in seat.
- The AAP and NHTSA recommend that children ride rear-facing until the age of 2 or until they reach the maximum rear facing height or weight rating for their car seat. This car seat can remain rear-facing up to 40 lb (18 kg).

⚠ WARNING!



NEVER place this child restraint rear-facing in a vehicle seating location that has an active front air bag.

* Check your state laws and the AAP/NHTSA recommendations. See page 25.

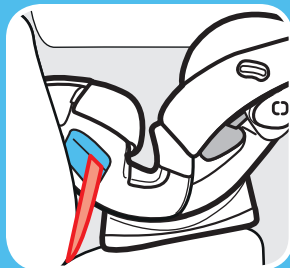

Vehicle Seat Lap Belt



3 Rear Facing

3-B Install Rear-Facing with LATCH Straps

Review your vehicle's owner manual for LATCH location and use.

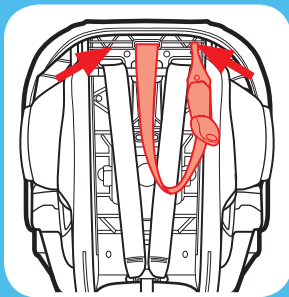

1. Store Top Tether Strap

Attach tether hook to the plastic bar on either side of the car seat.

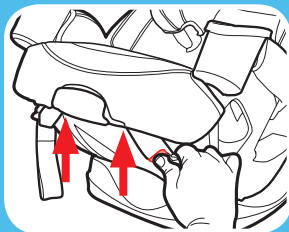

2. Remove LATCH Strap from Storage Location

Push in on the red buttons on the LATCH connectors and remove from storage position.



3 Rear Facing

3. Make Sure LATCH Strap is in the Rear-Facing Belt Path Marked With a Blue Label

If not, See section 7 to move LATCH strap.

4. Recline the Car Seat

Place the car seat in 1st, 2nd or 3rd recline position.

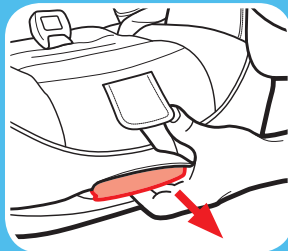
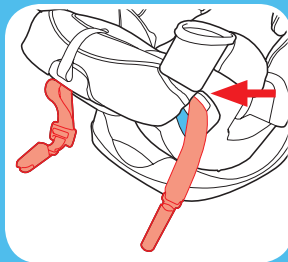
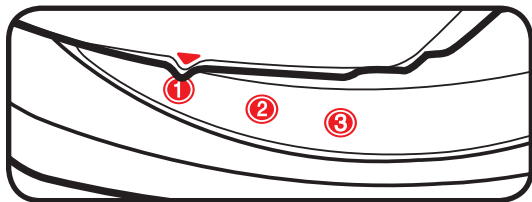

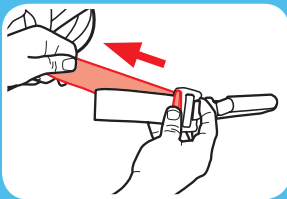

5. Place Car Seat Rear-Facing in Back Seat of the Vehicle

Place rear-facing in vehicle seat and center the car seat between the lower LATCH anchors. The base should sit as flat as possible on the vehicle seat.

6. Extend the LATCH Strap.

For easier installation, extend the LATCH strap to its maximum length by pressing the grey button and pulling on the strap.

7. Check the Level Indicator

Vehicle **MUST** be on level ground.

Check the level indicator on the car seat. The **bubble must be completely within** the blue zone.

Adjust the recline until the bubble is completely within the blue zone.

8. Attach LATCH Connectors to Vehicle's Lower LATCH Anchors.

LATCH strap should lie flat and not be twisted.

LATCH can only be used if the vehicle LATCH anchor spacing is 11" (28 cm) from the center of one LATCH anchor to the center of the other LATCH anchor.

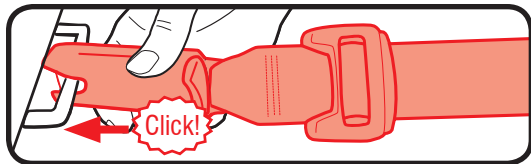

9. Tighten the LATCH Strap

Press down firmly in the center of the car seat while tightening the LATCH strap. You may need to tighten through the slit in the pad at the belt path as shown.

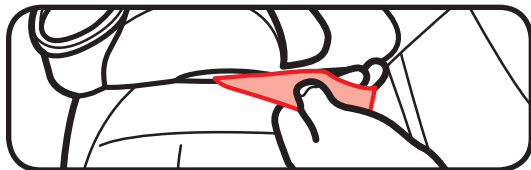

39

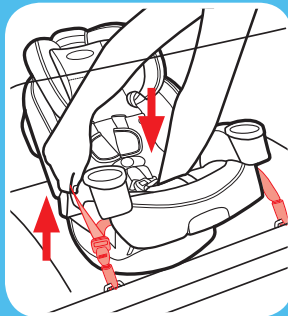
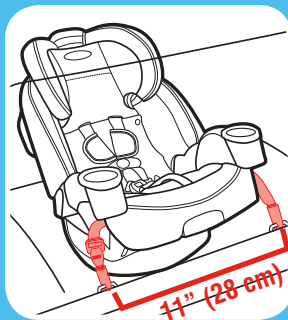

continue next page



3 Rear
Facing

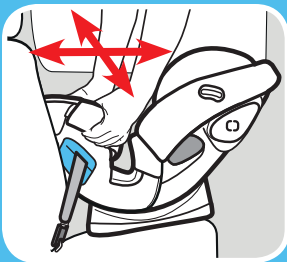

10. Test For Tightness

Grab the sides of the seat where the LATCH strap is and slide the car seat side-to-side and front-to-back.

If the seat moves less than 1" (2.5 cm), it is tight enough.



11. Check the Level Indicator

Vehicle **MUST** be on level ground.

Check the level indicator on the car seat. The **bubble must be completely within** the blue zone. Readjust if needed.

See section 6-A to secure your child.

Recheck the level indicator with child in seat.

Is Everything Correct?

Car Seat Does Not Move More than 1" (2.5 cm) at the Belt Path

Level Indicator's Bubble in the Blue Zone and Vehicle on Level Ground



Harness Straps at or Just Below the Child's Shoulders.

Review section 6

Chest Clip Even With Armpits

Review section 6

Cannot Pinch Harness Straps at the Shoulder

Review section 6

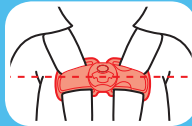
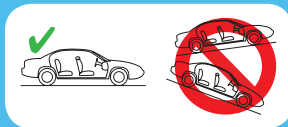

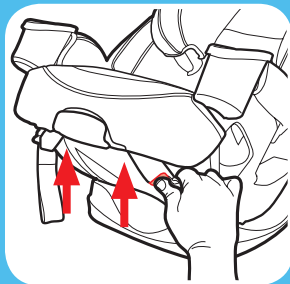

3 Rear Facing

3-C Install Rear-Facing with Vehicle Seat Belt

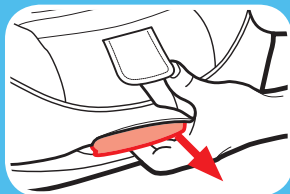
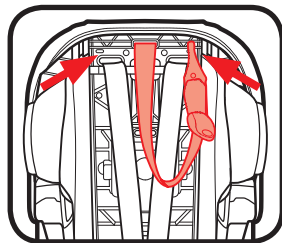

1. Store Top Tether and LATCH Straps

Attach tether hook and LATCH connectors to the plastic bars as shown.



2. Recline the Car Seat

Place the car seat in 1st, 2nd or 3rd recline position.

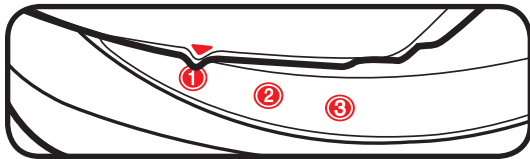

3 Rear
Facing

3. Place Car Seat Rear-Facing in Back Seat of the Vehicle

Place rear-facing in vehicle seat. The base should sit as flat as possible on the vehicle seat.

4. Check the Level Indicator

Vehicle **MUST** be on level ground.

Check the level indicator on the car seat. The **bubble must be completely within** the blue zone.

Adjust the recline until the bubble is completely within the blue zone.



3 Rear Facing

Review your vehicle's owner manual for vehicle seat belt use

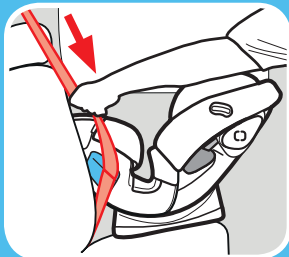
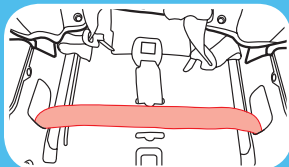
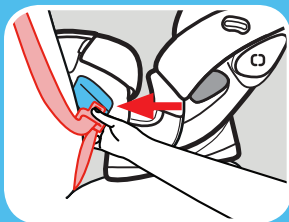

5. Route the Vehicle Seat Belt

Thread vehicle seat belt through the rear-facing belt path (marked with a blue label) and out the other side. Buckle it. The seat belt should lie as flat as possible and not be twisted.

Note: It may be easier to route the vehicle seat belt by lifting seat pad up to expose the belt path.

Make sure the vehicle seat belt is in front of the buckle strap when the buckle is in the inner-most position, and in behind when in the outer-most position.

6. Lock Vehicle Seat Belt

In most vehicles today, slowly pull the shoulder belt all the way out and then let it go back in. You will hear a clicking sound. Slowly pull out on the belt and it should be locked. If not, review your car's owner manual and section 9-D.



**3 Rear
Facing**

7. Tighten the Vehicle Seat Belt

Press down firmly in the center of the car seat. Pull on the shoulder belt to tighten while feeding the slack back in the retractor.

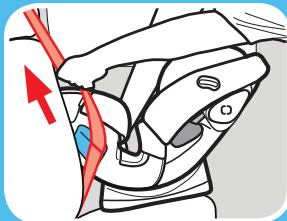

8. Test For Tightness

Grab the sides of the seat where the vehicle seat belt is and slide the car seat side-to-side and front-to-back.

If the seat moves less than 1" (2.5 cm), it is tight enough.

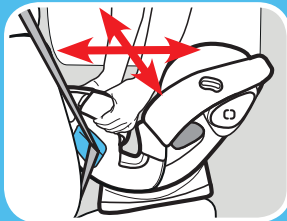

9. Check the Level Indicator

Vehicle **MUST** be on level ground.

Check the level indicator on the car seat. The **bubble must be completely within** the blue zone. Readjust if needed.

See section 6-A to secure your child.

Recheck the level indicator with child in seat.





3 Rear Facing

Is Everything Correct?

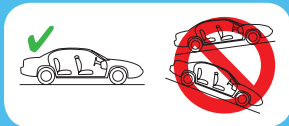

Car Seat Does Not Move More than 1" (2.5 cm) at the Belt Path



Level Indicator's Bubble in the Blue Zone and Vehicle on Level Ground



Harness Straps at or Just Below the Child's Shoulders.

Review section 6

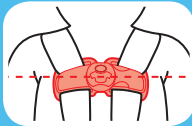

Chest Clip Even With Armpits

Review section 6



Cannot Pinch Harness Straps at the Shoulder

Review section 6

46



3 Rear Facing

4-A Forward-Facing Use

Forward-Facing:
22-65 lb (10-30 kg)
49" (125 cm) or less*

- For children **40 lb or less (18 kg)**, **MUST** use recline position 4 or 5.
For children over 40 lb (18.1 kg) you **MUST** use recline position 6.
- Place car seat forward-facing in the vehicle back seat.
- Make sure LATCH strap or vehicle seat belt is routed through the forward-facing belt path marked with an orange label.
- Install this car seat tightly in your vehicle. Car seat **should not move** at the forward-facing belt path more than 1" (2.5 cm) from side to side, front to back.
- Harness straps need to be **even with or just above** the top of child's shoulders and chest clip is at **armpit level**.

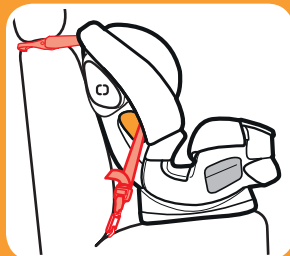

LATCH Strap with Top Tether Strap

Do not install by this method for a child weighing more than 45 lb (20 kg)



4 Forward Facing

4 Forward Facing

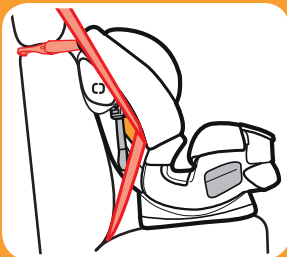

Vehicle Lap/Shoulder Belt with Top Tether Strap

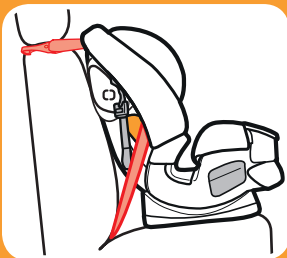

Vehicle Seat Lap Belt with Top Tether Strap

- The AAP and NHTSA recommend that children ride rear facing until the age of 2 or until they reach the maximum rear-facing height or weight rating for their seat, and when forward-facing, children should use the built-in harness system for as long as possible until they reach the maximum forward-facing weight or height for their car seat. This car seat can remain rear-facing up to 40 lb (18 kg) and forward-facing up to 65 lb (30 kg).

*Check your state laws and the AAP/NHTSA recommendations. See page 25.

4-B Install Forward-Facing with LATCH Straps

Review your vehicle's owner manual for LATCH location and use. Do not install by this method for a child weighing more than 45 lb (20 kg)

1. Remove LATCH Strap from Storage Location

Push in on the red buttons on the LATCH connectors and remove from storage position.

2. Make Sure LATCH Strap is in the Forward-Facing Belt Path Marked with Orange Label

To move the LATCH strap, review section 7.

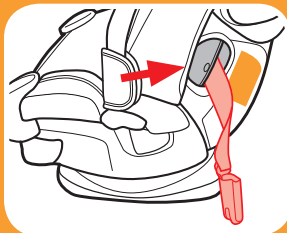
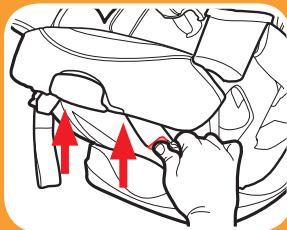

4 Forward Facing

4 Forward Facing

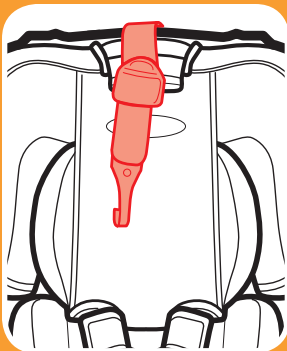

3. Unhook Top Tether Strap From Storage

Unhook tether and lay it in the seat.

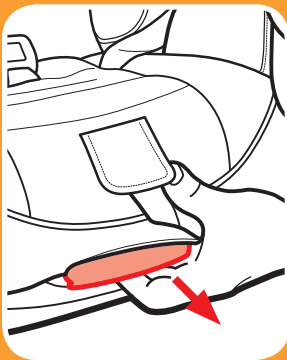
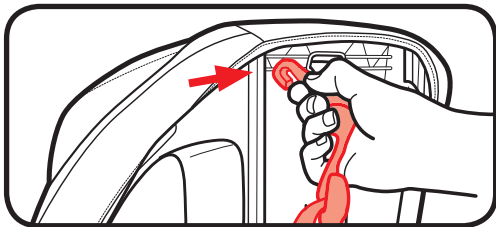

4. Adjust the Car Seat

For children 40 lb or less (18 kg), **MUST** use recline position 4 or 5.

For children over 40 lb (18.1 kg) you **MUST** use recline position 6.

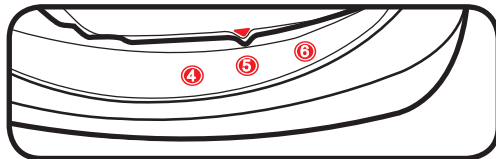

5. Place Car Seat Forward- Facing in Back Seat of the Vehicle

Place forward-facing in vehicle seat and center the car seat between the lower LATCH anchors. The base should sit as flat as possible on the vehicle seat.

6. Extend the LATCH Strap.

For easier installation, extend the LATCH strap to its maximum length by pressing the grey button and pulling on the strap.

7. Attach LATCH Connector to Vehicle's Lower LATCH Anchors.

LATCH strap should not be twisted.

LATCH can only be used if the vehicle LATCH anchor spacing is 11" (28 cm) from the center of one LATCH anchor to the center of the other LATCH anchor.

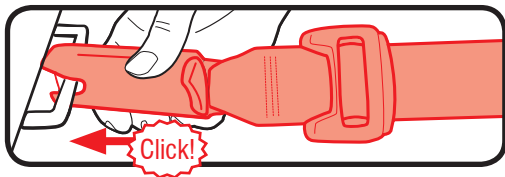

51

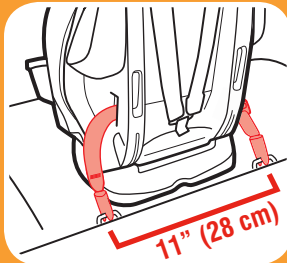
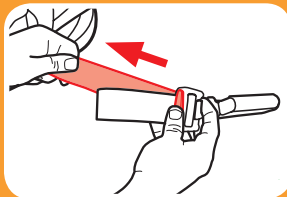

4 Forward Facing

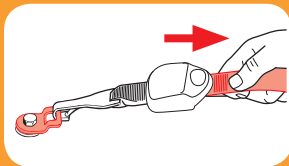
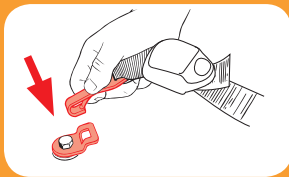
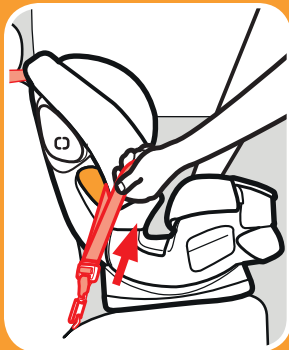

8. Tighten the LATCH Strap

Press down firmly in the center of the car seat while tightening the LATCH strap. You may need to tighten through the slit in the pad at the belt path as shown.

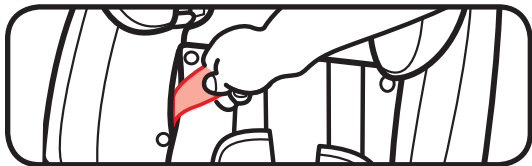

9. Attach Top Tether Strap

Extend the top tether by lifting up on the tether lock and attach.

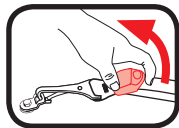

Consult vehicle's owner manual for specific location.

10. Tighten Top Tether Strap

Remove all the slack.

11. Test For Tightness

Grab the sides of the seat where the LATCH strap is and slide the car seat side-to-side and front-to-back.

If the seat moves less than 1" (2.5 cm), it is tight enough.

See section 6-A to secure your child.

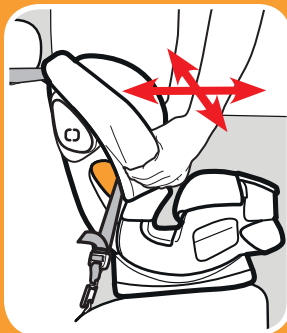

4 Forward
Facing

Is Everything Correct?



Car Seat Does Not Move More than 1" (2.5 cm) at the Belt Path



Harness Straps at or Just Above the Child's Shoulders.

Review section 6



Chest Clip Even With Armpits

Review section 6



Cannot Pinch Harness Straps at the Shoulder

Review section 6

4-C Install Forward-Facing with Vehicle Seat Belt



4 Forward Facing

1. Store LATCH Straps

Attach LATCH connectors to the plastic bars as shown.

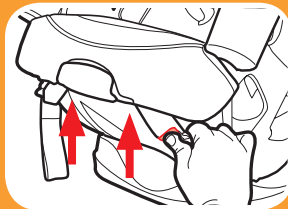

2. Unhook Top Tether Strap From Storage

Unhook tether and lay it in the seat.

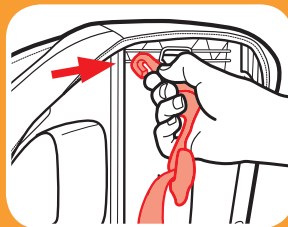
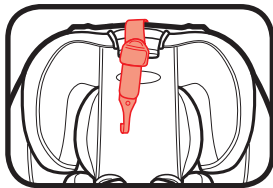

4 Forward Facing

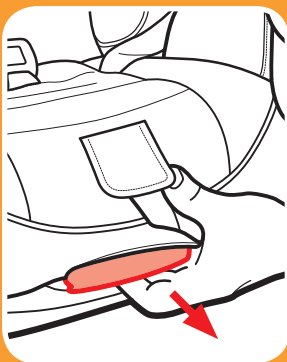

3. Place Car Seat Forward- Facing in Back Seat of the Vehicle

Place forward-facing in vehicle seat. The base should sit as flat as possible on the vehicle seat.

4. Adjust the Car Seat

For children 40 lb or less (18 kg), **MUST** use recline position 4 or 5.

For children over 40 lb (18.1 kg) you **MUST** use recline position 6.

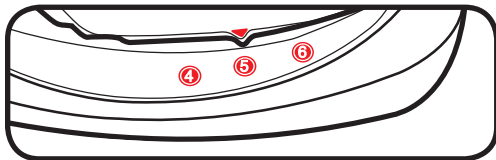

Using With the Lock-Off:

5. Expose the Lock-Off

- A.** Loosen the harness straps.
- B.** Raise the headrest to the highest position.
- C.** Unbuckle the chest clip.
- D.** Unbuckle the buckle.

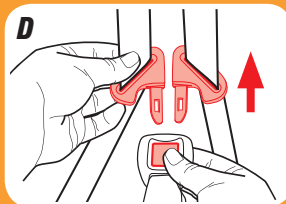
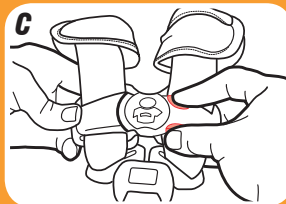
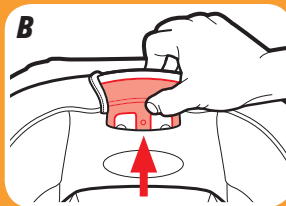
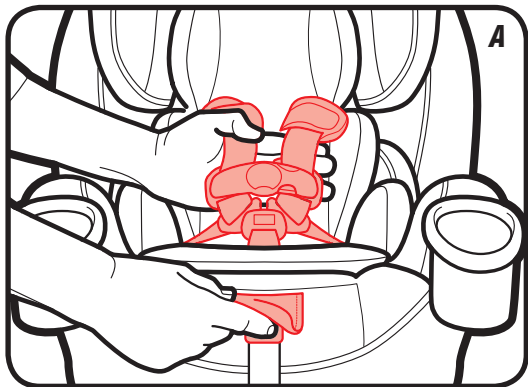

4 Forward
Facing

4 Forward Facing

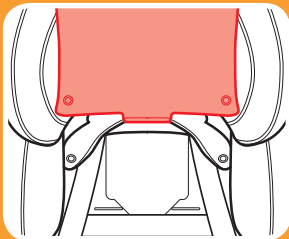

E. Lift the headrest pad flap up out of the way.

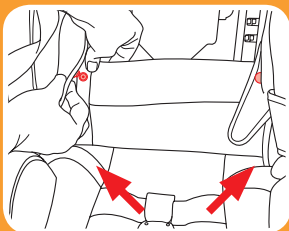

F. Undo the 2 lower snaps.

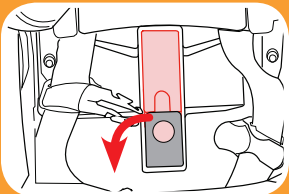

6. Open the Lock-Off

Hold the upper (red) latch in position, then flip down the lower (gray) tab. Release the upper latch.

Review your vehicle's owner manual for vehicle seat belt use

7. Route the Vehicle Seat Belt

Thread vehicle seat belt through the forward-facing belt path (marked with an orange label), through the lock-off, and out the other side. Buckle the seat belt. The seat belt should lie as flat as possible and not be twisted.

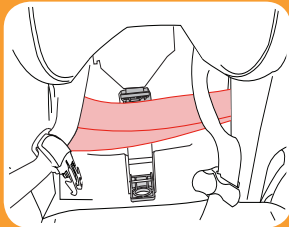
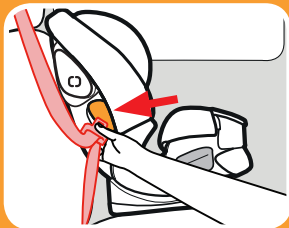

4 Forward Facing

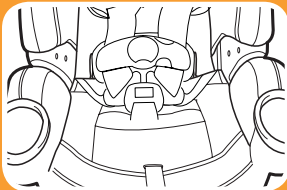
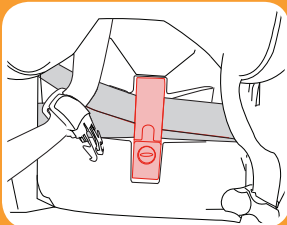
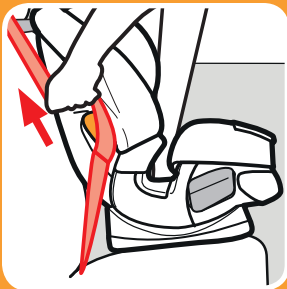

8. Tighten the Vehicle Seat Belt

Press down firmly in the center of the car seat. Pull on the shoulder belt to tighten. When the belt is tight, close and lock the lock-off on top of the vehicle seat belt.

*Make sure the lap and shoulder belt are both routed under the lock-off.

9. Replace the Seat Pad

Move the headrest back to its proper position for your child.

Review your vehicle's owner manual for vehicle seat belt use

Using Without the Lock-Off:

5. Route the Vehicle Seat Belt

Thread vehicle seat belt through the forward-facing belt path (marked with an orange label), through the lock-off, and out the other side. Buckle the seat belt. The seat belt should lie as flat as possible and not be twisted.

6. Lock the Vehicle Seat Belt

In most vehicles today, slowly pull the shoulder belt all the way out and then let it go back in. You will hear a clicking sound. Slowly pull out on the belt and it should be locked. If not, review your car's owner manual and section 9-D.

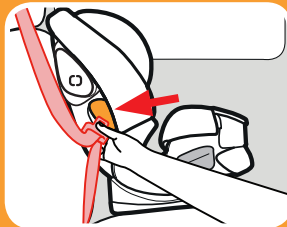

4 Forward Facing



7. Tighten the Vehicle Seat Belt

Press down firmly in the center of the car seat. Pull on the shoulder belt to tighten while feeding the slack back in the retractor.

After step 7, continue with step 10 on the next page.

10. Attach Top Tether Strap

Extend the top tether by lifting up on the tether lock and attach.

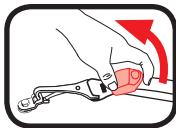

Consult vehicle's owner manual for specific location.

11. Tighten the Top Tether Strap

Push the car seat back while tightening the top tether strap to remove all the slack.

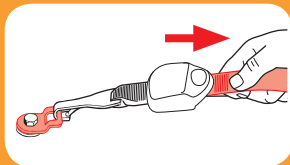
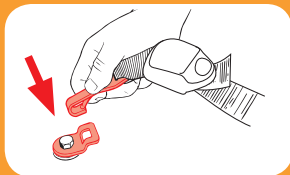

12. Test For Tightness

Grab the sides of the seat where the vehicle seat belt is and slide the car seat side-to-side and front-to-back.

If the seat moves less than 1" (2.5 cm), it is tight enough.

See section 6-A to secure your child.



4 Forward Facing

Is Everything Correct?



Car Seat Does Not Move More than 1" (2.5 cm) at the Belt Path

Harness Straps at or Just Above the Child's Shoulders.

Review section 6

Chest Clip Even With Armpits

Review section 6

Cannot Pinch Harness Straps at the Shoulder

Review section 6

5-A Booster Use

Booster Use With Back:
40-100 lb (18.1-45 kg) 43-57".
(110.1-145 cm) at least 4 years old*

Booster Use Without Back: 40-120 lb
(18.1-54 kg) 43-57". (110.1-145 cm)
at least 4 years old*

- Place car seat forward-facing in the vehicle back seat.
- Make sure vehicle seat's lap belt is adjusted snugly and lays low on the child's hip and is routed behind the armrest in the booster's belt path marked with green label.
- Vehicle belts **MUST** lie flat against child and **MUST NOT** be twisted.
- Vehicle seat's shoulder belt is adjusted snugly and should lie between child's neck and edge of shoulder.



**Vehicle Lap/Shoulder
Seat Belt**



**Vehicle Seat Lap/
Shoulder Belt**



5 Booster



Never Use a Vehicle Lap-Only Belt Across Front of Child

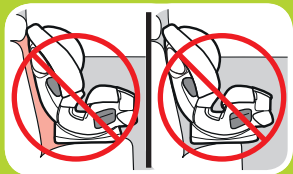

- **Never** use a vehicle lap-only belt across front of child.
 - **DO NOT** position vehicle shoulder belt under the child's arm or back.
 - **DO NOT** allow child to slouch or slide down in the booster seat.
 - **DO NOT** position vehicle belt over top of armrests.
 - Vehicle's seat headrest **SHOULD NOT** create a gap between vehicle seat and booster seat.
 - The front of booster seat **MUST NOT** hang over front of vehicle seat.
 - If child will not keep vehicle belt properly positioned, **DO NOT** use this booster seat. Use a different car seat.
 - The AAP and NHTSA recommend that children should use the built-in harness system for as long as possible until they reach the maximum forward-facing weight or height for their car seat, and after reaching the maximum forward-facing weight or height, that children 4 feet 9 inches tall or under should ride in a belt-positioning booster seat.
- * Check your state laws and the AAP/NHTSA recommendations. See page 25.

5-B Install Backed Booster

1. Store The Harness System

- A. Loosen the shoulder straps as much as possible.**
- B. Raise the headrest to the highest position.**
- C. Unbuckle the chest clip and the buckle strap D.**

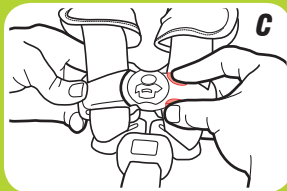
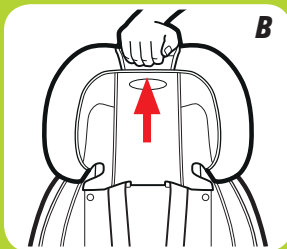
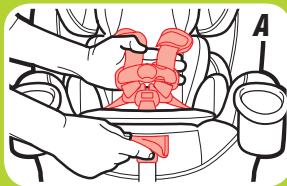
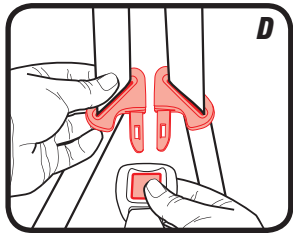

5 Booster



5 Booster

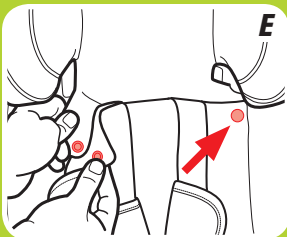

E. Unsnap Pad and Expose Seat Back

Undo the 2 snaps in the headrest pad.

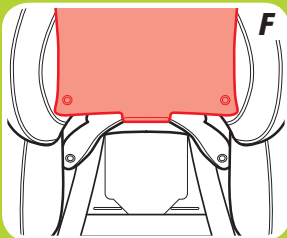

F. Lift the headrest pad flap up out of the way.

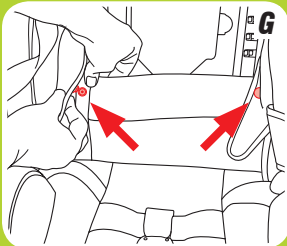

G. Unsnap Bottom Seat Pad

Undo the 2 lower snaps.

H. Pull Bottom Seat Pad Back To Expose the Plastic Shell

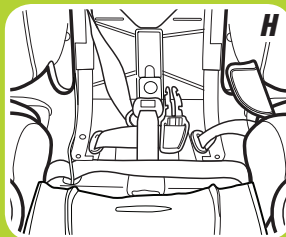

I. Open the Harness Storage Door

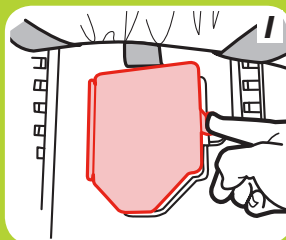

J. Place Harness, Chest Clip, Buckle Tongues, Harness Covers Inside Storage Compartment and Close the Door

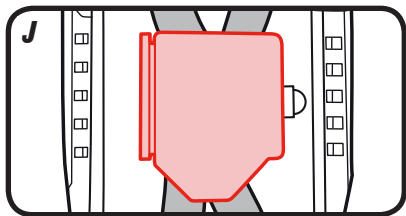

5 Booster

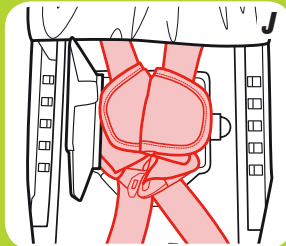



5 Booster

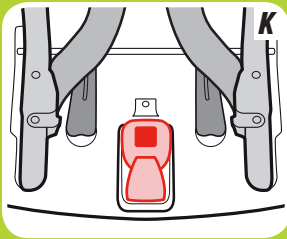

K. Store Buckle inside the groove in the car seat shell as Shown

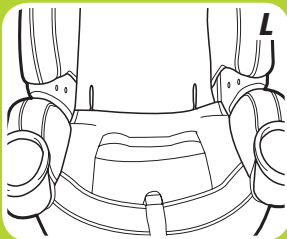

L. Replace Seat Pad

Move the headrest back to its proper position for your child.

2. Adjust the Car Seat

Place the car seat in the 6th recline position.

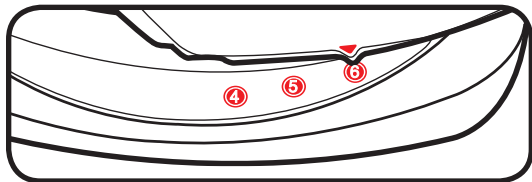

3. Place the Booster Seat Forward-Facing in the Back Seat of Vehicle

Place forward-facing on a vehicle seat that has a lap/shoulder seat belt. The base should sit as flat as possible on the vehicle seat.

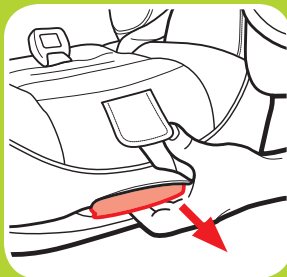

5 Booster

Graco allows the securing of the car seat with LATCH in the booster mode. The child still **MUST BE SECURED** with the vehicle lap/shoulder seat belt. LATCH can be used in the booster mode regardless of the weight of the child up to 100 lb (45 kg).

Verify the following before using LATCH in the booster mode:

- The LATCH connectors **DO NOT** interfere with any vehicle seat belts or buckles.

If the LATCH interferes with the vehicle seat belts or if the chosen seating position does not have LATCH, you **MUST** store the LATCH strap. Store the LATCH strap by pushing in on the red buttons on the connectors and attach to the plastic bar as shown. Store the top tether strap as shown.

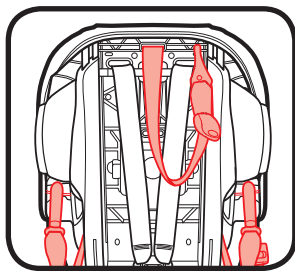

Skip to Step 10 if Not Using LATCH

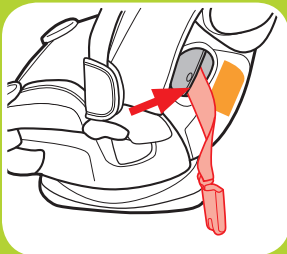

4. Make Sure LATCH Strap is in the Forward-Facing Belt Path Marked with Orange Label

Continue to next step if correct. See section 4 if it is not.

5. Unhook Top Tether Strap From Storage Location and Lay it in the Seat

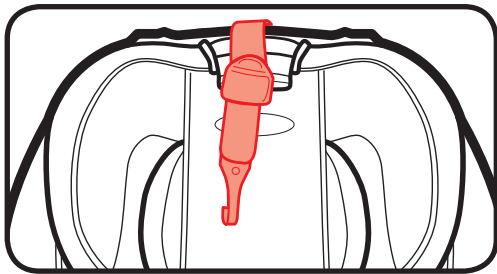

6. Attach LATCH Connector to Vehicle's Lower LATCH Anchors.

LATCH strap should not be twisted.

LATCH can only be used if the vehicle LATCH anchor spacing is 11" (28 cm) from the center of one LATCH anchor to the center of the other LATCH anchor.

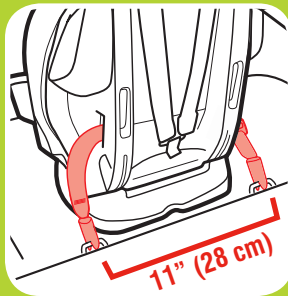
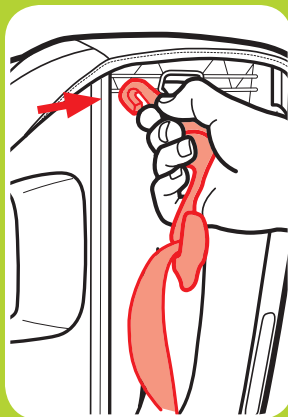
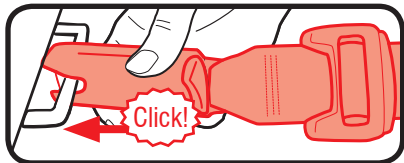

5 Booster



5 Booster

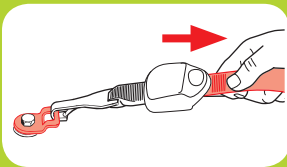
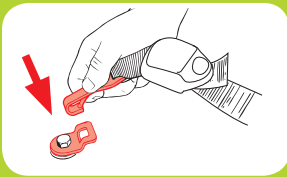
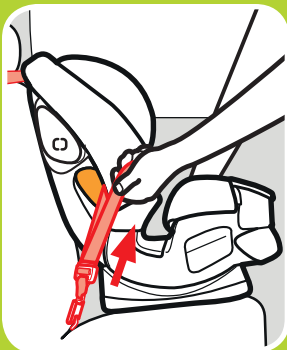

7. Remove all the slack from the LATCH strap.

8. Attach Top Tether Strap

Extend the top tether by lifting up on the tether lock and attach.

Consult vehicle's owner manual for specific location.

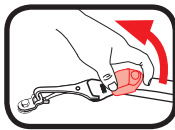

9. Tighten Top Tether Strap

Remove all the slack.

10. Thread the Vehicle Seat Shoulder Belt Through Seat Belt Guide on the Headrest

See section 6-B to secure your child.

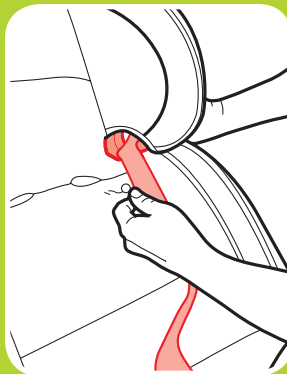

5 Booster

5-C Install Backless Booster

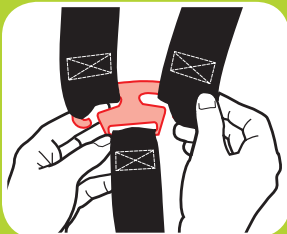
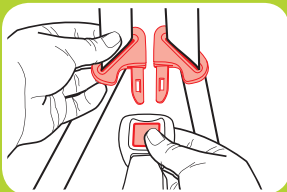
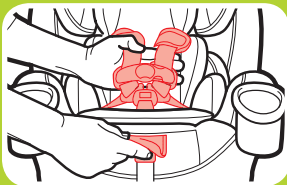

1. Remove the Seat Back by First Loosening the Harness Straps

Lift up on the harness release lever while pulling out on the harness straps at the chest clip.

Unbuckle the chest clip and the buckle strap.

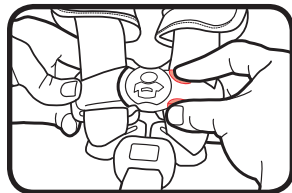

2. Remove Harness Straps from Splitter Plate

3. Make Sure LATCH Straps are in the Forward-Facing Belt Path and in the Stored Position

See section 7 to change positions.

4. Unsnap Bottom Seat Pad

Unsnap seat pad and expose the bottom of seat base.

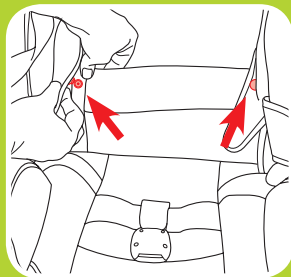
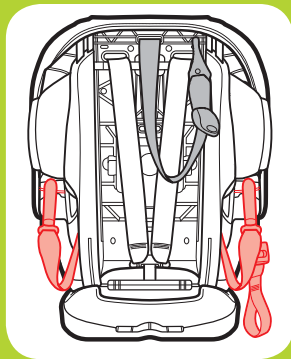

**5
Booster**



5 Booster

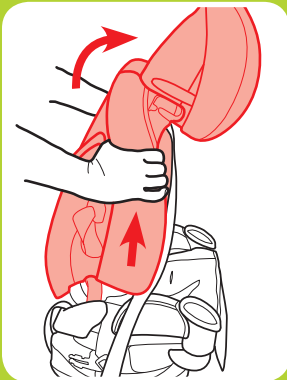
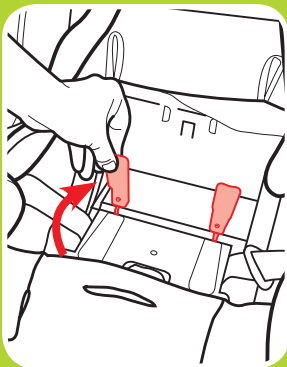

5. Lift the Red Backrest Lock Up

With the car seat in the 6th recline position, lift the red backrest locks up and slide together.

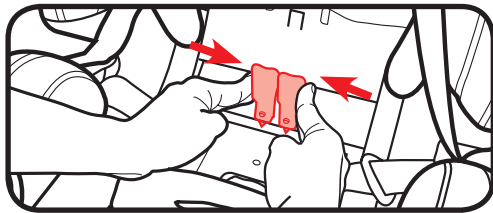

6. Remove Seat Back from Seat Base

Push the seat back up and lift out of base. To replace the seat back, reverse steps 4 through 6.

7. **Relock the Red Backrest Locks**

Make sure they are both flat and locked into place

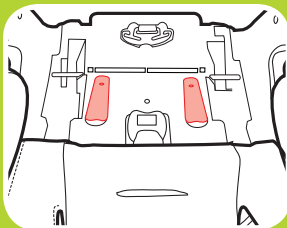

8. **Store Splitter Plate**

Pull the harness adjustment strap all the way out and then store the splitter plate.

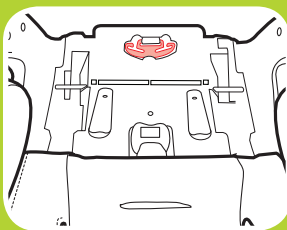

9. **Store Buckle Strap**

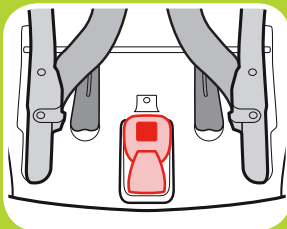

5 Booster



5 Booster

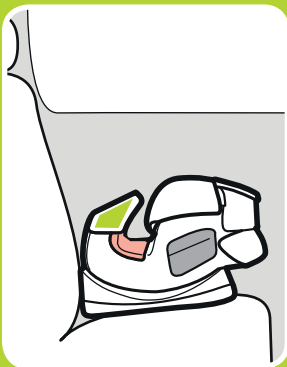
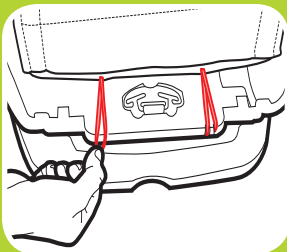

10. Attach Base Pad to the Back of Base

Attach the elastic straps onto base as shown.

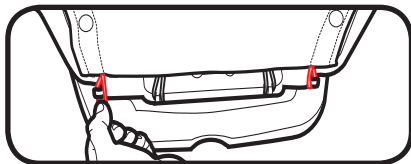

11. Place the Booster Seat Forward-Facing in the Back Seat of Vehicle

Place forward-facing on a vehicle seat that has a lap/shoulder seat belt. The base should sit as flat as possible on the vehicle seat.

See section 6-C to secure your child.

!WARNING!

WARNING! In cold weather, do not put snowsuits or bulky garments on your child when placing them in the car seat. Bulky clothing can prevent the harness straps from being tightened properly. To keep child warm, buckle your child in the car seat and place a blanket around the child or place the child's coat on backwards after buckling in.



6-A Securing Child 5-Point Harness

1. Loosen Harness Straps

(A) Lift up on the harness release lever while pulling out on the harness straps at the chest clip.

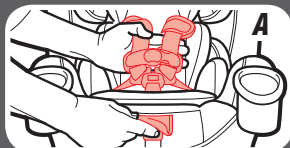

(B) Unbuckle the chest clip and the buckle. **(C)** Place harness straps off to the sides.

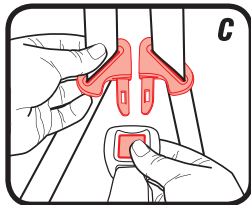

81

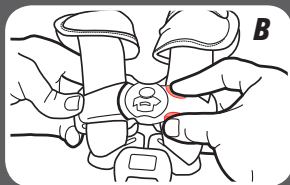

**6 Securing
Child**

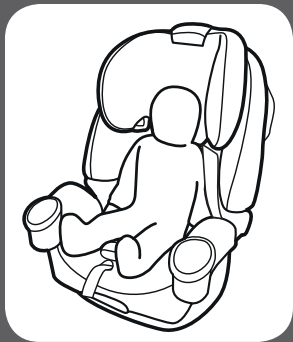

2. Place Your Child in the Seat

Make sure their back is flat against the car seat back.

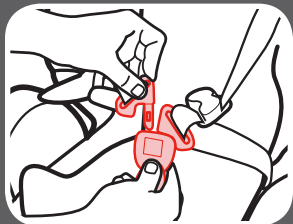

3. Place Harness Straps Over Child's Shoulders and Buckle

You will hear a “click” when buckle tongues are securely attached. Pull up on each buckle tongue to make sure it is securely attached.

4. Be Sure the Harness Straps Are at the Proper Height

Rear-Facing: Harness straps must be **at or just below** the child's shoulders and top of head **must be at least 1" (2.5 cm) below** the red headrest/harness adjustment handle.

Forward-Facing: Harness straps must be **at or just above** the child's shoulders and top of child's ears must be **below** top of headrest.

Remove the headrest and body pillow.

5. To Raise or Lower Headrest/Harness Adjustment Lever

Squeeze the adjustment lever and lift or lower headrest for the proper harness height.

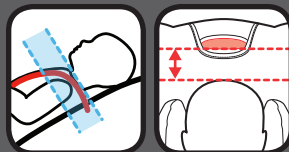
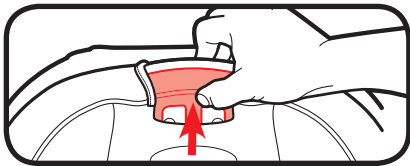

Rear-Facing

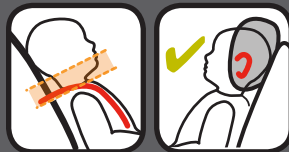

Forward-Facing

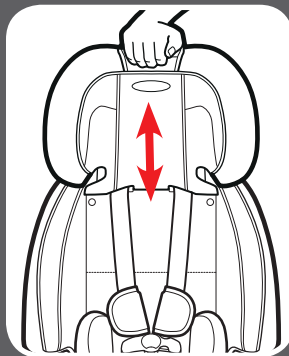

6 Securing
Child

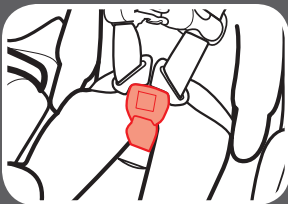

6. Check the Buckle Position

The correct slot is the one that is closest to your child without being underneath your child.

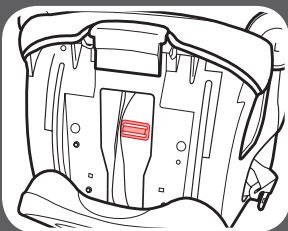

7. To Adjust Buckle Strap

Recline the car seat and locate the metal retainer under the car seat shell.

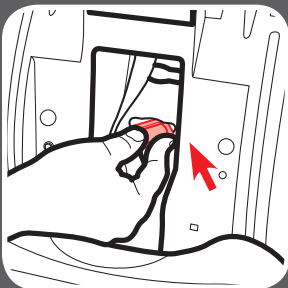

8. Rotate Metal Retainer and Insert It Up Through the Shell and Pad

From the top of the car seat, pull the buckle out.

9. Insert Metal Retainer in the New Buckle Strap Slot

Reach underneath the car seat and pull the metal retainer through.

10. Pull Up on Buckle Strap to Make Sure it is Secured

Rear-Facing: Make sure the LATCH strap is in front of the buckle strap when the buckle is in the inner-most position (A), and in behind when in the outer-most position (B) and that it is flat and is not twisted.

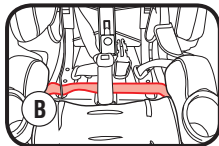
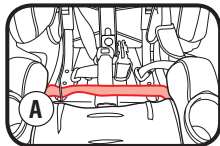

Forward-Facing: Make sure the LATCH strap is routed behind the harness strap, is flat, and is not twisted.

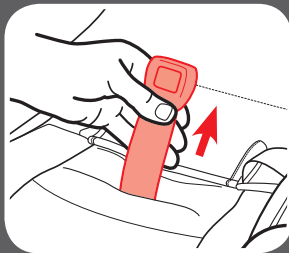
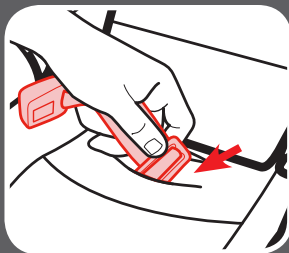

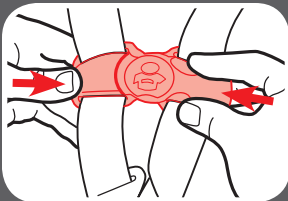

11. Buckle the Chest Clip

You will hear a “click” when the chest clip is securely buckled.

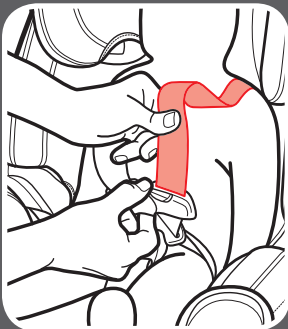

12. Pull All the Slack Out From Around the Waist

Pull up on the harness strap while pushing the chest clip down. Do this to both sides.

13. Tighten the Harness by Pulling the Harness Adjustment Strap

When you are not able to pinch any of the harness webbing at your child's shoulder, the harness is tight enough.

A snug harness should not allow any slack. It lies in a relatively straight line without sagging. It does not press on the child's flesh or push the child's body into an unnatural position.

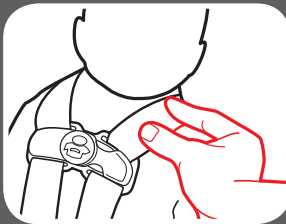
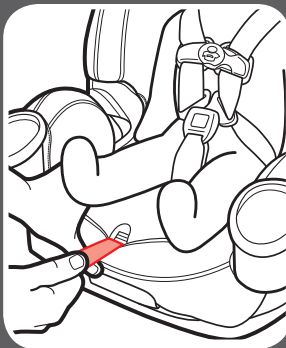

**6 Securing
Child**

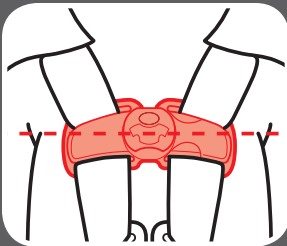

14. Raise the Chest Clip to Child's Armpit Level

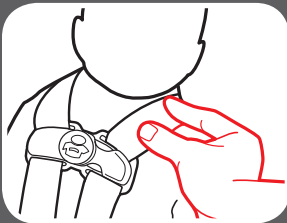

15. Check Tightness Again, Tighten More if Needed

6-B Securing Child Backed Booster

⚠ WARNING!

Use only the vehicle lap and shoulder belt system when restraining the child in the booster seat.

1. Place Child In Seat

Have your child sit in the booster seat, with his/her back flat against the back of the booster seat.

2. Thread Vehicle's Shoulder Belt Into Seat Belt Guide in the Headrest

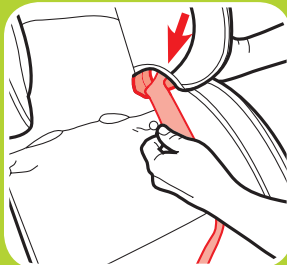
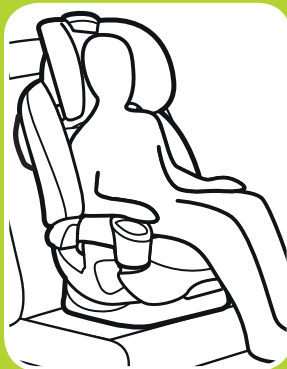

6 Securing
Child

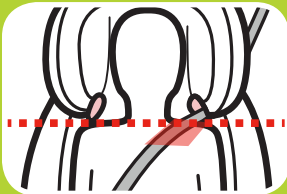
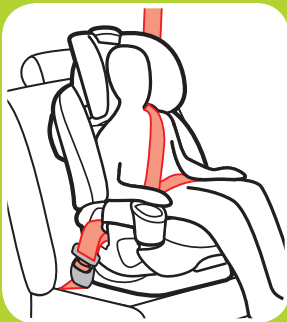

3. Buckle the Vehicle Lap/Shoulder Seat Belt

Be sure the lap portion of the vehicle seat belt goes behind the armrests.

Be sure the lap portion of the vehicle seat belt lies low across your child's hips.

Be sure the shoulder belt lies across your child's shoulders, between the neck and edge of shoulder. The belt guides should be even with or just above the shoulders.

Is Everything Correct?

Never Use Lap Belt Only



Lap Belt Behind Armrest and Lies Low Across Hips and Thighs



Shoulder Belt Lies On the Shoulder, Between the Neck and Edge of Shoulders



**6 Securing
Child**

6-C Securing Child Backless Booster

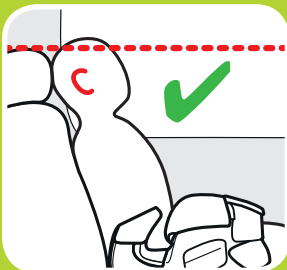

!WARNING!

Use only the vehicle lap and shoulder belt system when restraining the child in the booster seat.

1. Place Child In Seat

Have your child sit in the booster seat, with his/her back flat against the back of the vehicle seat.

2. Ears Must Be Below the Top of the Vehicle Seat Back or Headrest.

3. Buckle the Vehicle Lap/Shoulder Seat Belt

Be sure the lap portion of the vehicle seat belt goes behind the armrests.

Be sure the lap portion of the vehicle seat belt lies low across your child's hips.

Be sure the shoulder belt lies across your child's shoulders, between the neck and edge of shoulder.

You may need to use the belt positioning clip to help get a good fit.

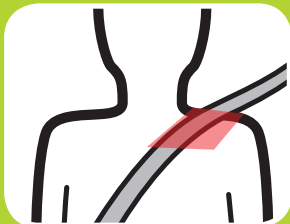
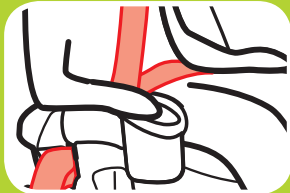

**6 Securing
Child**

Is Everything Correct?



Never Use Lap Belt Only



Lap Belt Behind Armrest and Lies Low Across Hips and Thighs



Shoulder Belt Lies On the Shoulder, Between the Neck and Edge of Shoulders

Using Belt Positioning Clip

1. Make Sure Vehicle's Seat Shoulder Belt Lays in the Red Zone As Shown

If the vehicle's seat shoulder belt lays outside this zone, you **MUST** use the belt positioning clip.

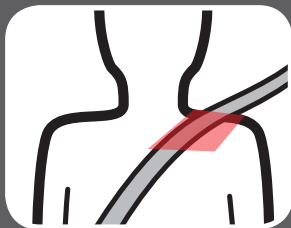

2. Attach Belt Positioning Clip

Insert the loop end of the strap through the same slot as the harness adjustment strap as shown.

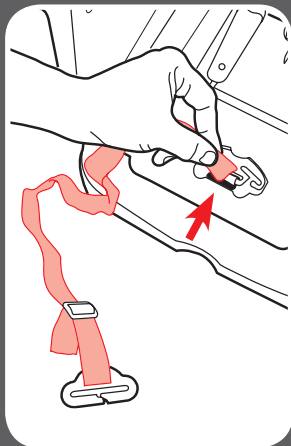

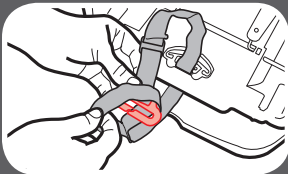

6 Securing
Child

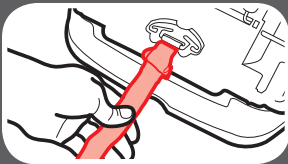

3. Push Clip and Strap Through Loop

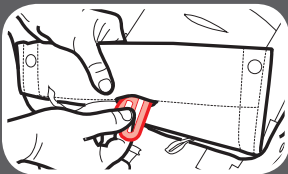

4. Pull to Tighten Strap



5. Push Clip Through Slot In Pad

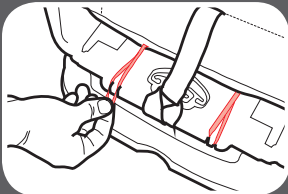

6. Attach Seat Pad to Base

7. Place Child in Seat, Buckle Child In Seat and Attach Belt Positioning Clip

With child's back flat against the back of the vehicle seat, buckle child in. Then slide the clip onto the vehicle's seat shoulder belt as shown.

8. Adjust the Belt Positioning Clip to Fit Your Child

Lengthen or shorten the belt length as shown.

Clip should fit right at the top of shoulder as shown.

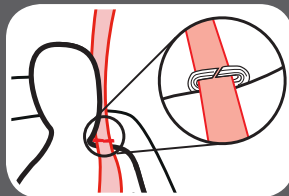
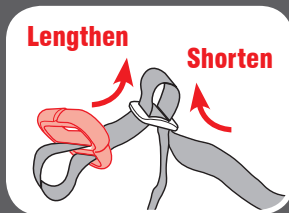
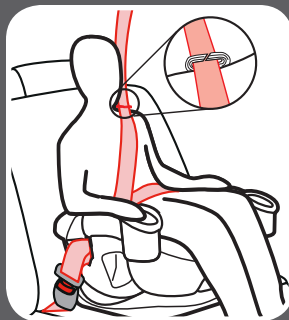

6 Securing
Child

7-A Moving the LATCH Strap

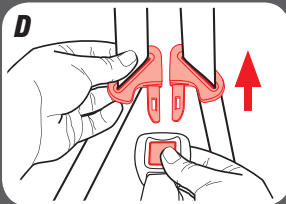
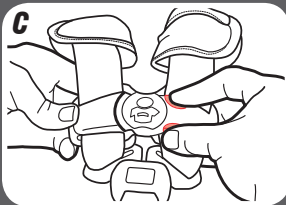
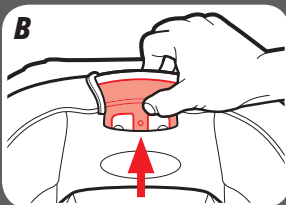

1. For Ease of Moving the LATCH Strap

- A.** Loosen the harness straps.
- B.** Raise the headrest to the highest position.
- C.** Unbuckle the chest clip.
- D.** Unbuckle the buckle.

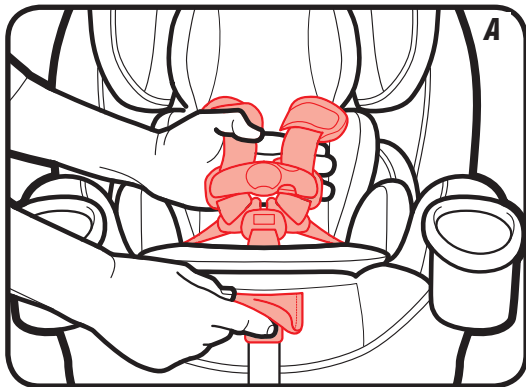

2. **Unsnap Bottom Seat Pad to Expose the LATCH Strap**

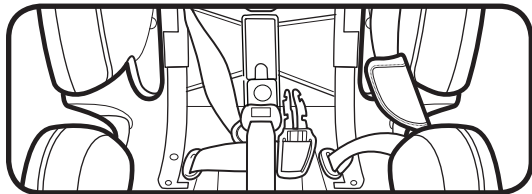

3. **Pull LATCH Connectors Out of the Belt Path Openings into the Center of the Car Seat**

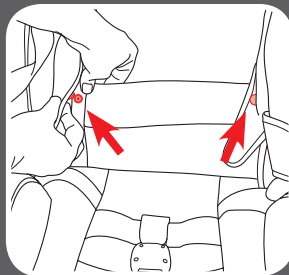

4. **Slide Entire LATCH Strap Along Bar to the Desired Belt Path Openings**

Rear-Facing: Slide LATCH strap along bar to the front of the seat.

Forward-Facing: Slide the LATCH strap up along bar to the top.

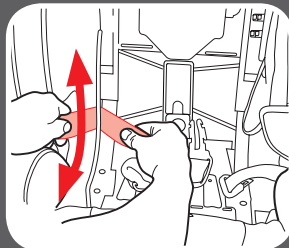
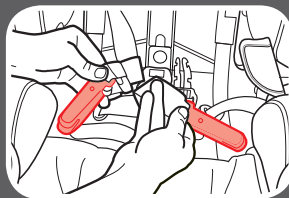

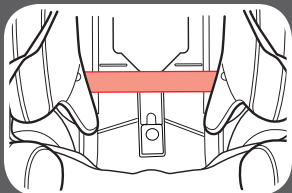
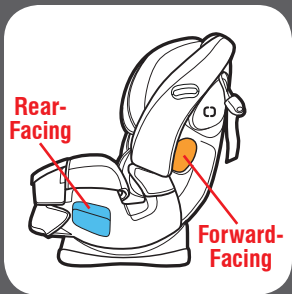

5. Push the LATCH Connectors Out Through the Desired Belt Path Openings on Each Side of Car Seat

Rear-Facing:

Make sure the LATCH strap is in front of the buckle strap when the buckle is in the inner-most position (A), and in behind when in the outer-most position (B) and that it is flat and is not twisted.

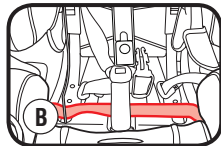
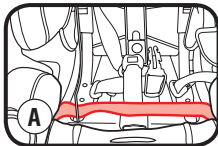
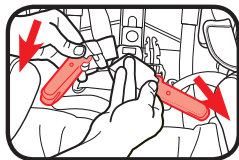

Forward-Facing: Make sure the LATCH strap is routed behind the harness strap, is flat, and is not twisted.

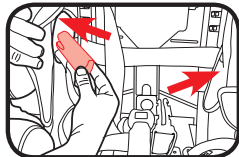

6. Replace Seat Pad

7. Move the Headrest to Its Proper Position for Your Child

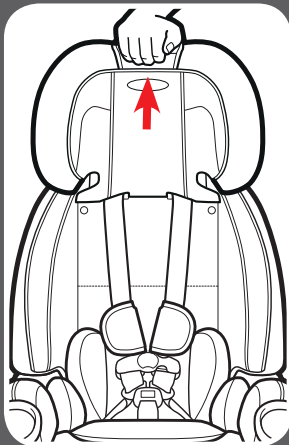
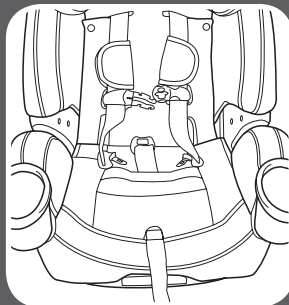

7 Moving
LATCH

8-A Accessories *(on select models)*

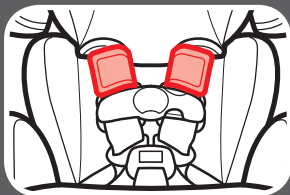

Harness Covers

Make sure that harness covers do not interfere with placement of the chest clip at armpit level.

To remove, undo the fastening strips and remove.

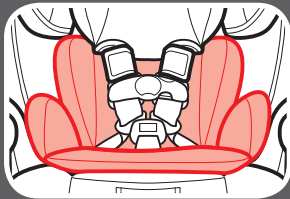

Body Support

Use only in the rear-facing mode.

Body support must be used if shoulders are below the lowest harness setting.

Never allow body support to bunch or fold behind child.

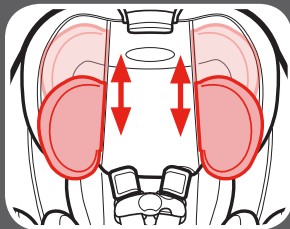

Headrest Pillow

Use only in the rear-facing mode. To adjust the pillow, pull up until desired height. Do not use without the body pillow.

To remove, slide the pillow out from the body support.

9-A How to Remove LATCH and Top Tether

LATCH

To remove the LATCH from the lower anchors, push in on the red buttons and pull them off.

Top Tether

To remove, lift up on the tether lock to release the tension.

Press in on the hook's spring. Push tether hook in, then lift up and pull away from tether anchor.

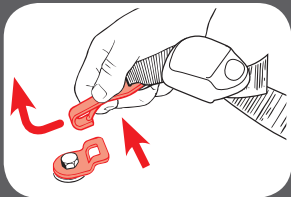
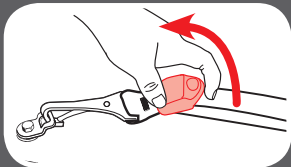
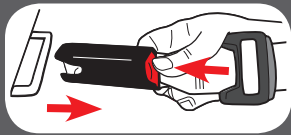

9-B Choosing Vehicle Seat Location

Review your vehicle's owner manual for Seating Locations

The best seating location for this car seat is one that:

- Is recommended by your vehicle owner's manual, and
- Results in a secure installation of this car seat

In the event there is no available back seat and / or you have no other option than to place a child other than an infant in a rear-facing car seat in a front passenger seating position, the National Highway Traffic Safety Administration (NHTSA) recommends that you take the following steps:

- Ensure the child is properly restrained according to their age and size
- Move the seat as far back as possible
- Make sure the child is not leaning out of position, such as leaning forward into the deployment path of the air bag
- Set the air bag ON-OFF switch, if available, to the OFF position
- Move the seat as far back as possible

9-C Unsafe Vehicle Seat Location

Never install this car seat in any of the following vehicle seating locations:



rear-facing or side-facing vehicle seats



rear-facing with an active front air bag



booster mode with vehicle lap belt only seat belt

9-D Vehicle Seat Belts

Review your vehicle's owner manual for vehicle seat belt use

This car seat can be installed using a vehicle seat belt. To do this, you will need to change the seat belt to a locked mode for use with car seats. With some vehicle seat belts, this is done with the latchplate; with other vehicle seat belts, this is done with the retractor.

Vehicle Seat Belt Terms

Retractor

A device that winds up the unused vehicle seat belt. It is often hidden inside the panels on the walls of the vehicle or in the vehicle seatback.

Latch Plate

The male end of the seat belt with the silver tongue.

Seat Bight

The crease where the vehicle seat back and seat bottom meet.

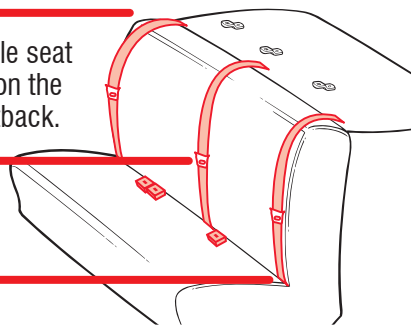

Identify Your Seat Belt Type

There are two different types of vehicle seat belts that can be used with this car seat:

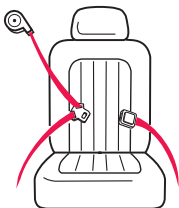

Lap/Shoulder Belt

3 connection points. Can be used in all car seats modes of use.

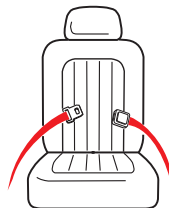

Lap Belt Only

2 connection points. **Can ONLY be used in harness mode.**

The following types of vehicle seat belts **CANNOT** be used safely with this car seat:



Lap Belt with Motorized
Shoulder Belt



Lap Belt or Shoulder
Belt Mounted on Door



Belts Forward of the
Seat Bight

Lap/Shoulder Belt Installation - Rear-Facing/Forward Facing Modes

Always review your vehicle owner's manual for specific information about your vehicle seat belts.

There are three types of retractors: **ELR (Emergency Locking Retractor)**, **ALR (Automatic Locking Retractor)**, and **Switchable (ELR switch to ALR)**. To determine your type of retractor, follow these steps:

1. **Slowly** pull the belt out about halfway and stop.
2. Let the belt retract back several inches.
3. Try to **slowly** pull the belt out more. If the belt cannot be pulled any further, it is **ALR**. If it can be pulled further, go to the next step.
4. **Slowly** pull the belt all the way out, and then allow it to retract several inches.
5. Try to pull the belt all the way out again. If it cannot be pulled out, it is **Switchable**. If it can still be pulled out freely, it is **ELR**.

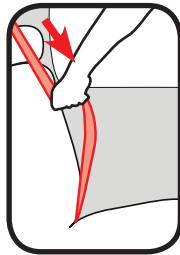

Note: Most vehicles manufactured after 1996 will have Switchable retractors in the back seat. If you have any questions about your retractor type, consult your vehicle owner's manual or call Graco for assistance.

How to Lock Your Lap and Shoulder Vehicle Seat Belt

Sliding Latch Plate and Switchable Retractor

A latchplate that slides freely on the belt webbing and cannot, by itself, hold the belt snug around a car seat.

When installing the car seat, route the vehicle seat belt through the proper belt path and buckle it in. **Slowly pull the shoulder belt all the way out to switch it to locking mode.** Then, as you pull the vehicle seat belt tight, feed all the slack back into the retractor.

Grab the sides of the seat at the belt path and slide the seat side-to-side and front-to-back. The seat should not move more than 1" (2.5 cm).

Note: With the vehicle seat belt in this locking mode, all the tension is upwards in the shoulder belt. This may start to tilt your car seat sideways when rear-facing. If this happens, use a locking clip instead of this switching the retractor. See Sliding Latch Plate and ELR Retractor.

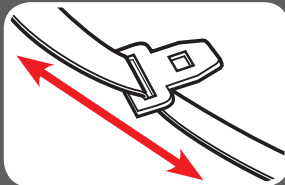

Note: When using the lock-off, you do not need to switch the retractor. The lock-off locks the seat belt.

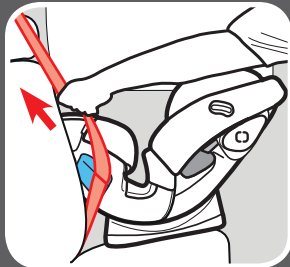
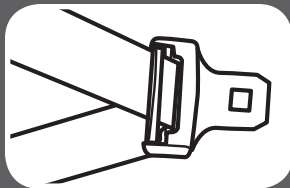

Locking Latchplate and ELR Retractor

A latchplate that holds the lap belt snug after it has been adjusted; contains a metal bar on the underside of the hardware that “locks” the belt in position.

When installing the car seat, route the vehicle seat belt through the proper belt path and buckle it in. Then, pull upwards on the shoulder belt so that the lap belt gets tight around the car seat.

Grab the sides of the seat at the belt path and slide the seat side-to-side and front-to-back. The seat should not move more than 1” (2.5 cm).

Note: When using the lock-off, you do not need to switch the retractor. The lock-off locks the seat belt.

Sliding Latch Plate and ALR Retractor

A latchplate that slides freely on the belt webbing and cannot, by itself, hold the belt snug around a car seat.

Slowly pull the shoulder belt all the way out. Route the vehicle seat belt through the proper belt path and buckle it in. Then, as you pull the vehicle seat belt tight, feed all the slack back into the retractor.

Grab the sides of the seat at the belt path and slide the seat side-to-side and front-to-back. The seat should not move more than 1" (2.5 cm).

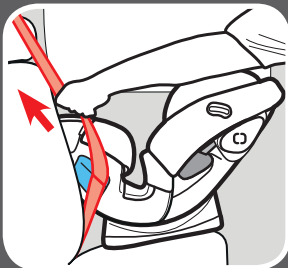
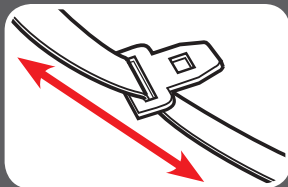

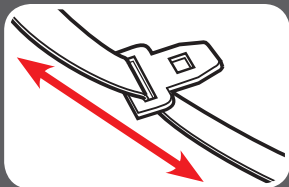

Locking Clip



Sliding Latch Plate and ELR Retractor

A latchplate that slides freely on the belt webbing and cannot, by itself, hold the belt snug around a car seat.

With this retractor, you will need to use the locking clip to lock the vehicle seat belt.

To get a locking clip order online at gracobaby.com or call 1-800-345-4109

Route the vehicle seat belt through the proper belt path and buckle it in. Pull the vehicle seat belt tight. While pushing down on seat, pinch the two straps together behind the buckle tongue. Unbuckle the belt without allowing it to slip.

Attach locking clip to lap and shoulder belts as shown.

Rebuckle belt. Check that lap belt does not move by pulling hard. If belt loosens or lengthens, repeat procedure.

Note: When using the lock-off, you do not need to use the locking clip. The lock-off locks the seat belt.

Lap Belt Installation - DO NOT use in Booster Mode

Always review your vehicle owner's manual for specific information about your vehicle seat belts.

Locking Latch Plate and No Retractor

When installing the car seat, route the lap seat belt through the proper path and buckle it in. Then, pull upwards on the tail of the belt so that the lap belt gets tight around the car seat.

Sewn On Latch Plate and ALR

Slowly pull the lap belt all the way out.

Route the vehicle seat lap belt through the proper belt path and buckle it in. Then, pull the lap belt tight while feeding all the slack back into the retractor.

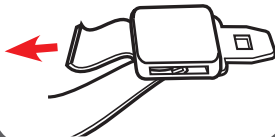

Grab the sides of the seat at the belt path and slide the seat side-to-side and front-to-back. The seat should not move more than 1" (2.5 cm).



10-A Cleaning Seat Pad

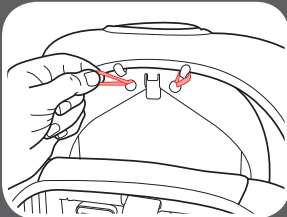
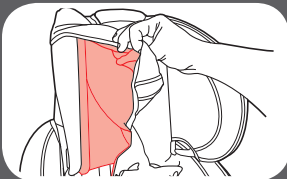
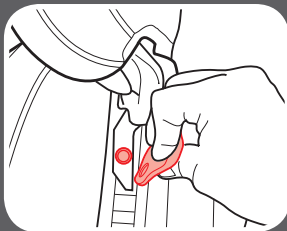

Refer to seat pad care tag for washing instructions.

Headrest Pad

Clean with a damp sponge using mild soap and cool water. If needed, pad may be removed for cleaning.

To remove, unsnap headrest pad from plastic shell.

Undo the 2 elastic straps from the back of headrest and remove the pad. Slide the elastic retaining loops out of the belts guides.

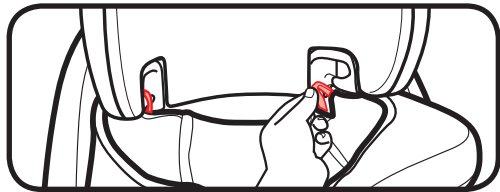

Machine wash pad in cold water on delicate cycle and drip-dry. **DO NOT USE BLEACH.**

Reverse the steps to reattach the pad on the headrest.

Seat Pad

Clean with a damp sponge using mild soap and cool water. If needed, cover may be removed for cleaning.

To remove, unsnap base pad from side pad. Undo the elastic straps in the rear-facing belt path. Pull plastic tab out of armrest. Undo the 2 elastic straps by the recline handle.

Machine wash pad in cold water on delicate cycle and drip-dry. **DO NOT USE BLEACH.**

Reverse the steps to reattach the pad to the shell.

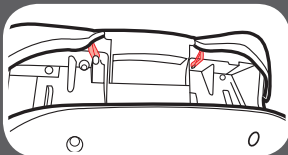
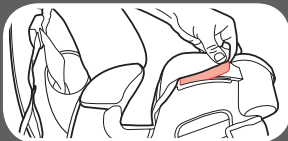
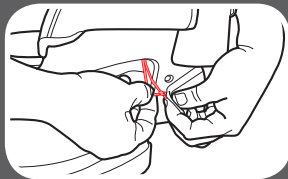
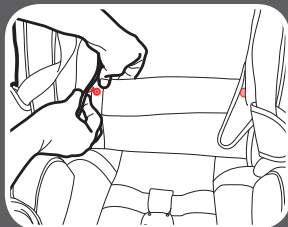

10-B Cleaning Buckle Strap

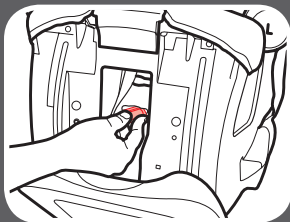
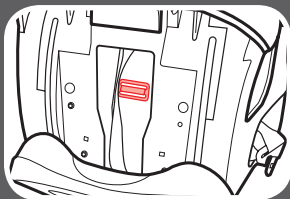

Recline the car seat and locate the metal retainer. Rotate the metal retainer up through the shell and pad. From the front, pull the buckle strap out.

To clean buckle, place in a cup of warm water and gently agitate the buckle. Press the red button several times while in the water.

DO NOT SUBMERGE THE BUCKLE STRAP. DO NOT USE SOAPS, HOUSEHOLD DETERGENTS or LUBRICANTS.

Shake out excess water and allow to air dry. Repeat steps as needed until it fastens with a click. Re-insert the buckle into the same slot it was removed. Pull up on buckle strap to make sure it is secured.

WARNING! Inspect and clean buckle from time to time to remove any objects or debris that could prevent latching.

10-C Cleaning Harness and LATCH Straps

Surface wash only with mild soap and damp cloth. **DO NOT IMMERSE THE HARNESS STRAPS or LATCH STRAP IN WATER** Doing so may weaken the straps.

If harness straps or LATCH belt are frayed or heavily soiled, contact Customer Service at www.gracobaby.com or 1-800-345-4109.

Notes

Notes

Replacement Parts

To purchase parts or accessories in the United States,
please contact us at the following:

www.gracobaby.com

or

1-800-345-4109



Store instruction manual in
the slot with the instruction
book icon as shown.

