

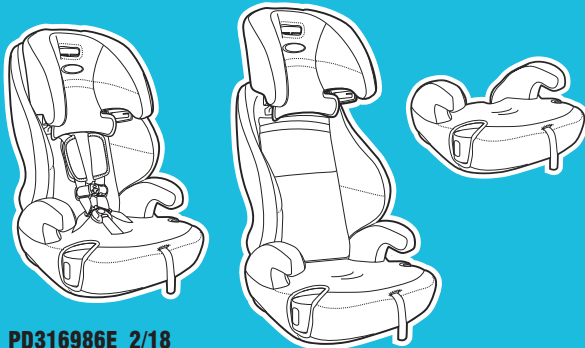

# TRANZITIONS/WAYZ

CHILD RESTRAINT/BOOSTER SEAT

**Read This Instruction Manual**



PD316986E 2/18

**Do not install or use  
this child restraint until you read  
and understand the instructions in  
this manual.**

**FAILURE TO PROPERLY USE THIS  
CHILD RESTRAINT INCREASES  
THE RISK OF SERIOUS INJURY  
OR DEATH IN A SUDDEN STOP OR  
CRASH.**

# **1 Important**

*Pages 6-22*

**1-A Quick Guide to Your Manual**

**1-B Welcome to the Graco Family**

**1-C Right Mode of Use**

**1-D Before You Begin**

Register This Car Seat

If You Need Help

Certification

Car Seat's Useful Life

Vehicle Seat Protection

Warm Weather Use

**1-E Safety Warnings**

## **2 Features**

*Pages 23-29*

**2-A Cup Holder**

**2-B Car Seat Features**

## **3 Forward-Facing**

*Pages 30-41*

**3-A Forward-Facing Use**

**3-B Install Forward-Facing with LATCH Straps**

**3-C Install Forward-Facing with the Vehicle Seat Belt**

## **4 Booster**

*Pages 42-52*

**4-A Booster Use**

**4-B Install Backed Booster**

**4-C Install Backless Booster**

## **5 Securing Child**

*Pages 53-69*

- 5-A Securing Child 5-Point Harness**
- 5-B Securing Child Backed Booster**
- 5-C Securing Child Backless Booster**

## **6 Accessories**

*Page 70*

## **7 Vehicle Information**

*Pages 71-81*

- 7-A How to Remove LATCH and Top Tether**
- 7-B Choosing Vehicle Seat Location**
- 7-C Unsafe Vehicle Seat Location**
- 7-D Vehicle Seat Belts**

## **8 Care & Cleaning**

*Pages 82-86*

- 8-A Cleaning Seat Pad**
- 8-B Cleaning Buckle Strap**
- 8-C Cleaning Harness and LATCH Strap**



1 Important

## 1-A Quick Guide to Your Manual

**This car seat is for children: *Forward-Facing: 22-65 lb (10-30 kg)*  
*Booster: 30-100 lb (14-45 kg)***

### ***Get to Know Your Car Seat***

Review section 2-B to see all of the features of this car seat.

### ***What Seating Location Should I Use?***

***The best seating location for this car seat is one that:***

- Is recommended by your vehicle owner's manual, and
- Results in a secure installation of this car seat.

Some vehicles have specific requirements for where the car seat can be installed, so be sure to check your vehicle owner's manual for available seating positions, if any. For example, sometimes the center rear seat has a lap belt only vehicle seat belt, which cannot be used when this car seat is in Booster mode.

Review section 7-B, 7-C of this manual AND your vehicle owner's manual.

**According to accident statistics, the safest place for your child in any vehicle is the back seat. The center of the back seat can be the safest during a possible side impact.**



**1 Important**

### ***Which Installation Method Should I Use?***

This car seat can be installed in your vehicle using either the vehicle seat belt **OR** the lower anchor attachment. **DO NOT USE BOTH AT THE SAME TIME IN THE 5-POINT HARNESS MODE.** Graco allows the securing of the car seat with LATCH system in the booster mode only, if the vehicle manufacture allows it.

**Vehicle Seat Belt:** Review section 7 and your vehicle owner's manual to learn how to install your car seat with the vehicle seat belts.

**LATCH:** The LATCH system allows you to securely attach your car seat in your car without using the vehicle seat belt. All 2003 and newer model year vehicles are required to have lower anchor bars, although some manufacturers began including them earlier. Some vehicle owner manuals use the term ISOFIX to identify them.

## What is LATCH?

LATCH consists of lower anchor bars and a tether anchor bar, which are built-in to your vehicle, and connecting hooks that are built-in to your car seat. Lower anchors are used **INSTEAD** of the vehicle's seat belt to secure the child seat to the vehicle in the 5-point harness mode. The tether is used **IN ADDITION** to the lower anchors **OR** the vehicle's seat belt to secure a forward-facing 5-point harness mode car seat to the vehicle.

***Review your vehicle's owner manual for exact location and use.***

**Vehicle Tether  
Anchorage Points**

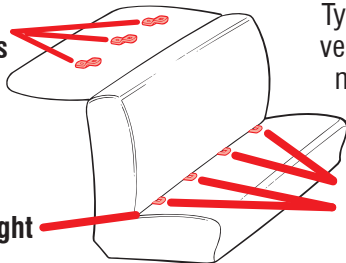

Typical seat in a passenger vehicle. Other vehicle types may have different lower anchor bar locations.

**Vehicle Seat Bight**

**Vehicle Lower  
Anchor Points**





## Using The Car Seat Correctly

To make sure your child is secured properly, review section 3 and 4 to fit your child.

### When Installing Forward-Facing

#### LATCH System

LATCH consists of lower anchors, which are built-in to your vehicle, and connecting hooks that are built-in to your car seat.

Review section 3-B of this manual AND your vehicle owner's manual.

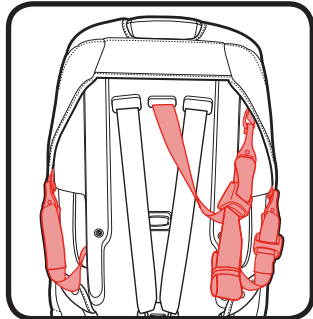
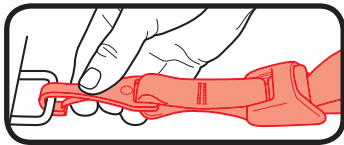

#### Vehicle Seat Belt

There are two types of vehicle seat belts that can be used. Lap/Shoulder Seat Belt or Lap Only Seat Belt.

Review section 3-C of this manual AND your vehicle owner's manual.

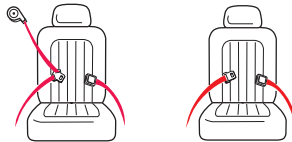

**i** 1 Important

## ***For Forward-Facing, You Need to Adjust:***

### **Harness Height, Forward-Facing (A)**

Harness straps at or just above the child's shoulders and top of child's ears below top of headrest **(B)**. Review section 5.

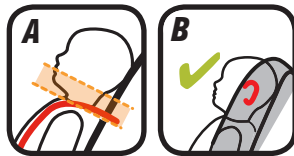

### **Buckle Position (C)**

The correct slot is the one that is closest to your child without being underneath them. Review section 5.

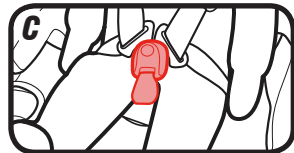

### **Harness Tightness (D)**

If your fingers slide off the harness straps without pinching the straps, it is tight enough. Review section 5.

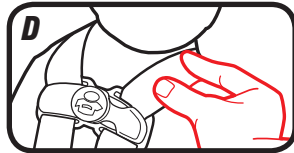

## Forward-Facing Installation

### Use the tether when using forward-facing (A)

When used properly, the tether helps reduce injury in a sudden stop or crash.

Review section 5

### Car Seat Does Not Move More than 1" (2.5 cm) at the Belt Path (B)

Review section 5

### Harness Straps at or Just Above Child's Shoulders (C)

Review section 5

### Chest Clip Even With Armpits (D)

Review section 5

Review section 5

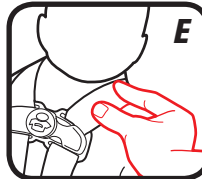
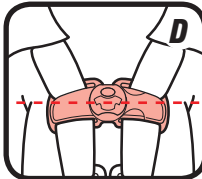
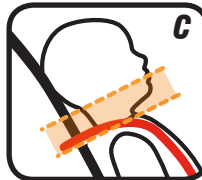
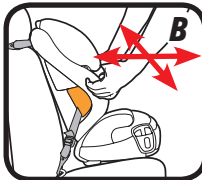
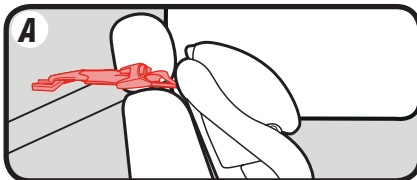

1 Important

## ***When Installing As a Booster***

### **Vehicle Seat Belt**

Only use the Lap/Shoulder seat belt configuration.

Review section 4-B, 4-C of this manual AND your vehicle owner's manual.

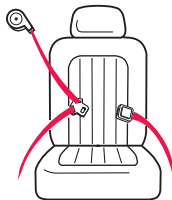

## ***For Booster, You Need to Adjust:***

### **Use Lap/Shoulder Belt Only**

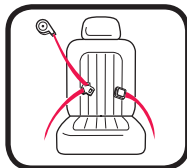

**Highback**



**Backless**

### **Position Lap Belt**

Lap belt must go in front of armrest and lie low across your child's hips and thighs.

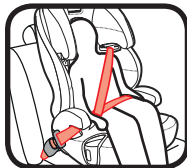

### **Position Shoulder Belt**

Shoulder belt lies across shoulder between neck and edge of shoulder.

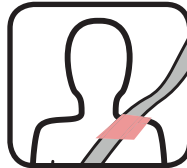

**1 Important**

## ***Booster Installation***

### **Never Use Lap Belt Only**

Review section 4



**Highback**



**Backless**

### **Lap Belt In Front of Armrest and Lies Low Across Hips and Thighs**

Review section 4

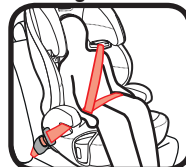

### **Shoulder Belt Lies On the Shoulder, Between the Neck and Edge of Shoulders**

Review section 4

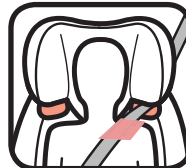

## 1-B Welcome to the Graco Family!

Your child's safety depends on you. No car seat can guarantee protection from injury in every situation, but proper use helps reduce the risk of serious injury or death.

Even if this car seat seems easy to figure out on your own, you must follow the detailed instructions in this instruction manual to ensure the steps below are performed correctly.



**1 Important**

**1 Important**

## 1-C Right Mode of Use

22 lb  
(10 kg)

30 lb  
(14 kg)

40 lb  
(18.1 kg)

65 lb  
(30 kg)

100 lb  
(45 kg)

**Forward-Facing with 5-Point Harness** 22-30 lb (10-14 kg) and can sit upright unassisted **MUST** be forward facing. 30-65 lb (14-30 kg) **SHOULD** be forward-facing with 5-Point Harness.

**High Back Booster Mode with Vehicle Lap/Shoulder Seat Belt** 30-65 lb (14-30 kg) **CAN** be in high back booster mode. Over 65 lb (30 kg) **MUST** be in booster mode.

**Backless Booster Mode with Vehicle Lap/Shoulder Seat Belt** 40-65 lb (18.1-30 kg) **CAN** be in booster mode. Over 65 lb (30 kg) **MUST** be in booster mode.

Check your state laws and the AAP/NHTSA recommendations. See page 22.



## 1-D Before You Begin

### *Register This Child Restraint*

Please fill out the prepaid registration postcard attached to the harness and mail it in today **or register online at [www.gracobaby.com/carseatregistration](http://www.gracobaby.com/carseatregistration).**

Child restraints could be recalled for safety reasons. You must register this restraint to be reached in a recall. Send your name, address, and the restraint's model number and manufacturing date to:

Graco Children's Products, Inc.  
Attn: Customer Service  
P.O. Box 169, Elverson, PA 19520-9901  
or call 1-800-345-4109

**or register online at [www.gracobaby.com/carseatregistration](http://www.gracobaby.com/carseatregistration)**

For recall information, call the U.S. Government's Vehicle Safety Hotline at  
1-888-327-4236  
(TTY: 1-800-424-9153), or go to <http://www.NHTSA.gov>.



1 Important



**1 Important**

For future reference or if you change addresses, record the model name, model number, date of manufacture and purchase date of this car seat on the below. You can find this information either on the registration card if you still have it or on the date label located on the back of the car seat.

**Model Name** \_\_\_\_\_

**Model Number** \_\_\_\_\_

**Date of Manufacture** \_\_\_\_\_

**Date of Purchase** \_\_\_\_\_

### ***If You Need Help***

In the U.S.A, please contact our Customer Service Department with any questions you may have concerning parts, use, or maintenance. When you contact us, please have your product's model number and date of manufacture ready so that we may help you efficiently. These numbers can be found on a sticker on the back side of your car seat.

For additional resources or to get your car seat checked by a child passenger safety technician, please visit the following web sites:

[www.nhtsa.gov](http://www.nhtsa.gov) • [www.seatcheck.org](http://www.seatcheck.org) • [www.safekids.org](http://www.safekids.org)



**1 Important**

## ***Certification***

This child restraint meets or exceeds all applicable requirements of Federal Motor Vehicle Safety Standard 213 for use in motor vehicles.



This child restraint is certified for use in aircraft only when used with the internal harness system. Use only on forward-facing aircraft seats. Follow the instructions for vehicle installation. See section 3-C and 7-D Lap Belt Installation except don't use the top tether.



This child restraint is NOT certified for use in aircraft when used as a booster seat because aircrafts do not have shoulder belts.

Contact the airline for their specific policies.

## ***Car Seat's Useful Life***

STOP using this car seat and throw it away 7 years after the date of manufacture. Look for date of manufacture label on back of the car seat.

Graco Children's Products Inc. advises against loaning or passing along a car seat unless you know the complete history of the product. We also advise against purchasing a car seat second hand.

## ***Vehicle Seat Protection***

Protect vehicle seat. Use a car seat mat, towel, or thin blanket under and behind car seat.

### **Warm Weather Use**

Car seat parts can get very hot in the sun or warm weather. **To avoid burns, always check before putting child in car seat.**

## **1-E Safety Warnings**

**No car seat can guarantee protection from injury in every situation, but proper use helps reduce the risk of serious injury or death. **READ THIS MANUAL CAREFULLY.****

### **WARNING!**

**Failure to follow these instructions and child restraint's labels can result in child striking the vehicle's interior during a sudden stop or crash.**

**! Review your vehicle owner's manual for more information about air bags and car seat use.**



**1 Important**

- ! If your vehicle does not have a back seat, review your vehicle owner's manual.**
- ! Select a suitable location for the car seat in your vehicle.**
- ! Secure car seat with a vehicle seat belt or LATCH that is properly routed as shown in this manual.**
- ! Vehicle seat belt system MUST hold car seat securely. Not all vehicle seat belts can be used with a car seat.**
- ! If vehicle seat belt does not hold car seat securely, read "Vehicle Seat Belts" section 7-D and your vehicle owner's manual.**
- ! Always secure car seat with LATCH or a vehicle seat belt, even when unoccupied. In a crash, an unsecured car seat can injure passengers.**
- ! If car seat is in a crash, it must be replaced. DO NOT use it again! A crash can cause unseen damage and using it again could result in serious injury or death.**
- ! DO NOT use car seat if it is damaged or missing parts.**
- ! DO NOT use accessories or parts other than those provided by Graco. Their use could alter the performance of the car seat.**

**1 Important**

**! The American Academy of Pediatrics (AAP) recommends that children should use the built-in harness system for as long as possible until they reach the maximum forward-facing weight or height for their car seat, and after reaching the maximum forward-facing weight or height, that children 4 feet 9 inches tall or under should ride in a belt-positioning booster seat. This car seat can remain forward-facing using the built-in harness system for children up to 65 lb (30 kg) or 49" (125 cm).**

**! DO NOT remove the lower anchor attachment from car seat. If using vehicle seat belt to secure car seat, lower anchor connectors must be stored.**

**! Never leave child unattended, even when sleeping. Child may become tangled in harness straps and suffocate or strangle.**

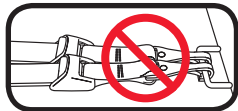

**! Never attach two LATCH hooks to one vehicle lower anchor bar unless specifically allowed by the vehicle manufacturer.**

**! Do not use both the vehicle seat belt and LATCH strap at the same time when using the car seat forward-facing with the 5-point harness.**

## 2-A Cup Holder

### ***Cup Holder***

To install cup holder, lift cup half out of the cup holder. Rotate cup. Align cup holder tabs with T-slots in shell and slide cupholder into place.

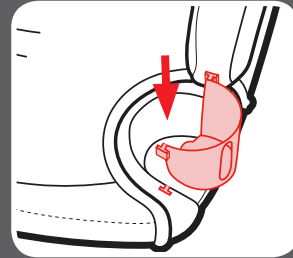
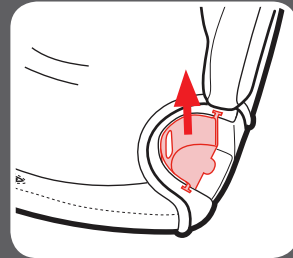

2 Features

## 2-B Car Seat Features



2 Features

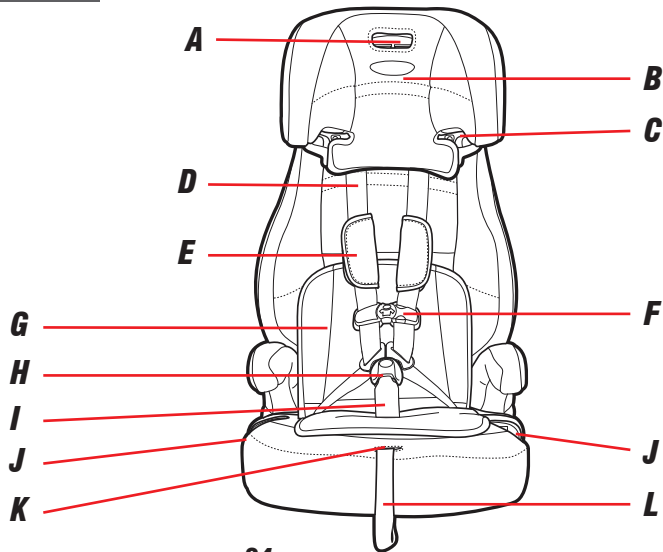



- A Height Adjust Lever**
- B Headrest**
- C Shoulder Belt Guide**
- D Harness Strap**
- E Harness Covers**
- F Chest Clip**
- G Body Support**
- H Buckle**
- I Buckle Strap**
- J Cup Holder**
- K Harness Adjuster Lever  
(Under Seat Pad)**
- L Harness Adjustment Strap**



## 2 Features

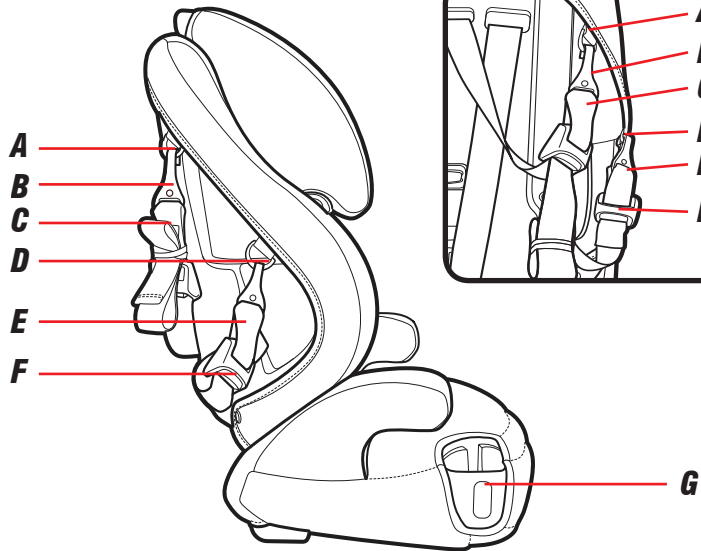

- A Tether Storage Ring**
- B Tether Hook**
- C Tether Strap**
- D LATCH Storage Ring**
- E LATCH Strap**
- F LATCH Adjuster**
- G Cup Holder**



## 2 Features

**B** ———

**C** ———

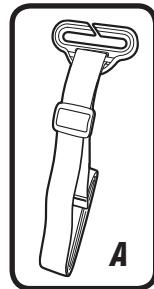
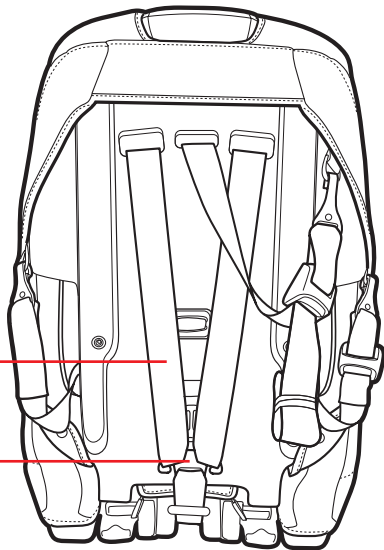

- A Belt Positioning Clip (Inset)**
- B Harness Straps**
- C Splitter Plate**

## 3-A Forward-Facing Use

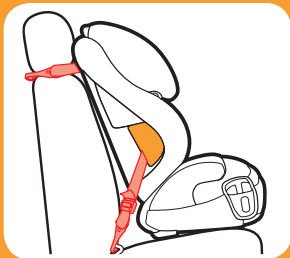

### **LATCH with Top Tether**

**Do not install by this  
method for a child  
weighing more than  
45 lb (20 kg)**

### **Forward-Facing:**

**22-65 lb (10-30 kg) and 49" (125 cm) or less\***

- Place car seat forward-facing in the vehicle back seat.
- Make sure LATCH strap or vehicle seat belt is routed through the forward-facing belt path marked with an orange label.
- Attach and tighten the tether. When used properly, the tether helps reduce injury in a sudden stop or crash.
- Install this car seat tightly in your vehicle. Car seat **should not move** at the forward-facing belt path more than 1" (2.5 cm) from side to side, front to back.
- Harness straps need to be **even with or just above** the top of child's shoulders and chest clip is at **armpit level**.

The AAP recommend that children should use the built-in harness system for as long as possible until they reach the maximum forward-facing weight and height for their car seat. This car seat can remain forward-facing using the built-in harness system for children up to 65 lb (30 kg) and 49" (125 cm). Do not install with the LATCH system for a child weighing more than 45 lb (20 kg) with the 5-point harness.

\* Check your state laws and the AAP/NHTSA recommendations.

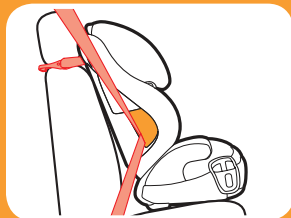

**Vehicle Lap/Shoulder Belt with Tether Strap**



**Vehicle Seat Lap Belt with Tether Strap**

  
3 Forward Facing

## 3-B Install Forward-Facing with LATCH Straps

*Review your vehicle's owner manual for LATCH location and use.*

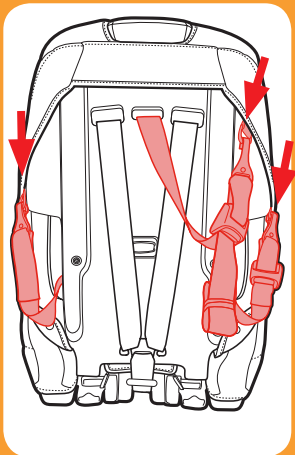

### 1. Remove LATCH and Tether Hook from Storage Locations

Unhook tether and lay it in the seat.

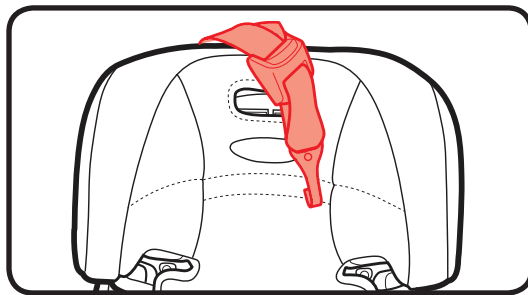



## **2. Place Car Seat Forward-Facing in Back Seat of the Vehicle**

Place forward-facing in vehicle seat. The bottom of the seat should sit as flat as possible on the vehicle seat.

## **3. Extend the LATCH Strap.**

For easier installation, extend the LATCH strap to its maximum length by pressing the grey button and pull out on the strap.

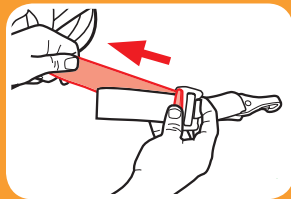

**3 Forward Facing**

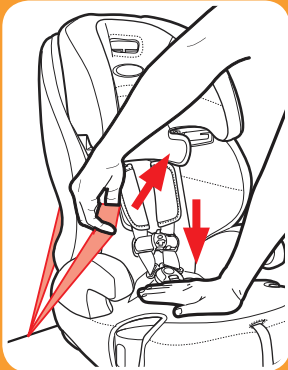
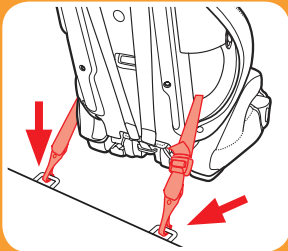

**4. Attach LATCH to Vehicle's Lower LATCH Bars.**

LATCH strap should not be twisted.

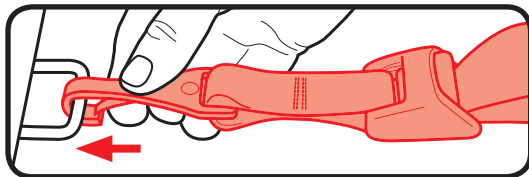

**5. Tighten the LATCH Strap**

Press down firmly in the center of the car seat while tightening the LATCH strap.

## 6. Attach Top Tether Hook

Extend the tether by pressing the grey button and pulling out on the strap and attach.

Consult vehicle's owner manual for specific location.

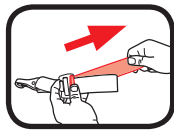

## 7. Tighten Tether Strap

Remove all the slack.

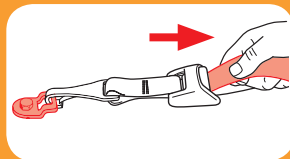
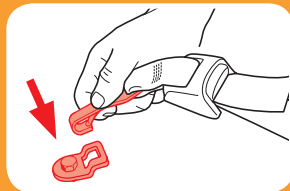

## 8. Test For Tightness

Grab the sides of the seat where the lower anchor strap is and slide the car seat side-to-side and front-to-back.

If the seat moves less than 1" (2.5 cm), it is tight enough.

**See section 5-A to secure your child.**



  
3 Forward Facing

**Is Everything Correct?**

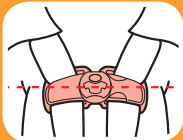
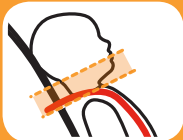

***Car Seat Does Not Move More than 1" (2.5 cm) at the Belt Path***

***Harness Straps at or Just Above the Child's Shoulders.***

Review section 5

***Chest Clip Even With Armpits***

Review section 5

***Cannot Pinch Harness Straps at the Shoulder***

Review section 5

## 3-C Install Forward-Facing with Vehicle Seat Belt

### 1. Store LATCH Strap

Attach LATCH hooks to the plastic rings as shown.

### 2. Unhook Top Tether Hook From Storage Location and Lay it in the Seat

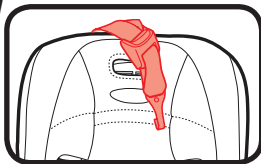

### 3. Place Car Seat Forward-Facing in Back Seat of the Vehicle

Place forward-facing in vehicle seat. The bottom of the seat should sit as flat as possible on the vehicle seat.



3 Forward Facing

***Review your vehicle's owner manual for vehicle seat belt use***

**3 Forward  
Facing**

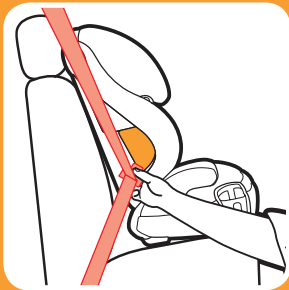

#### ***4. Route the Vehicle Seat Belt***

Thread vehicle seat belt through the forward-facing belt path (marked with a orange label) and out the other side. Buckle it. The seat belt should lie as flat as possible and not be twisted.

## 5. Lock the Vehicle Seat Belt

In most vehicles today, slowly pull the shoulder belt all the way out and then let it go back in. You will hear a clicking sound. Slowly pull out on the belt and it should be locked. If not, review your car's owner manual and section 7-D.

## 6. Tighten the Vehicle Seat Belt

Press down firmly in the center of the car seat. Pull on the shoulder belt to tighten while feeding the slack back in the retractor.



  
3 Forward Facing

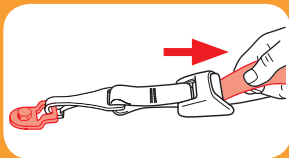
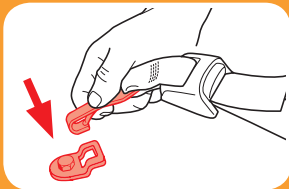

## 7. Attach Top Tether Strap

Extend the tether by pressing the grey button and pulling out on the strap and attach.

Consult vehicle's owner manual for specific location.

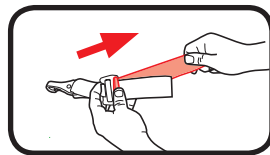

## 8. Tighten Tether

Remove all the slack.

## 9. Test For Tightness

Grab the sides of the seat where the vehicle seat belt is and slide the car seat side-to-side and front-to-back.

If the seat moves less than 1" (2.5 cm), it is tight enough.

**See section 5-A to secure your child.**



## ***Is Everything Correct?***

***Car Seat Does Not Move More than 1" (2.5 cm) at the Belt Path***

***Harness Straps at or Just Above the Child's Shoulders.***

Review section 5

***Chest Clip Even With Armpits***

Review section 5

***Cannot Pinch Harness Straps at the Shoulder***

Review section 5

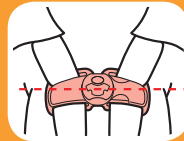
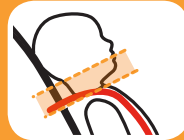

**3 Forward Facing**

## 4-A Booster Use

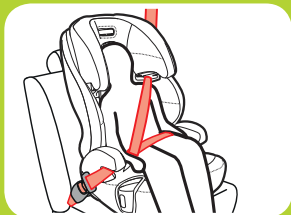

**Vehicle Lap/Shoulder  
Seat Belt**



**Vehicle Seat Lap/  
Shoulder Belt**

**Booster Use With Back:**  
**30-100 lb (14-45 kg) 38-57 in.**  
**(96-145 cm) at least 3 years old\***

**Booster Use Without Back: 40-100 lb (18.1-45  
kg) 43-57 in. (110.1-145 cm) at least 4 years  
old\***

- Place car seat forward-facing in the vehicle back seat.
- Make sure vehicle seat's lap belt is adjusted snugly and lays low on the child's hip and is routed in front of the armrest in the booster's belt path.
- Vehicle belts **MUST** lie flat against child and **MUST NOT** be twisted.
- Vehicle seat's shoulder belt is adjusted snugly and should lie between child's neck and edge of shoulder.

- **Never** use a vehicle lap-only belt across front of child.
- **DO NOT** position vehicle shoulder belt under the child's arm or back.
- **DO NOT** allow child to slouch or slide down in the booster seat.
- **DO NOT** position vehicle belt over top of armrests.
- Vehicle's seat headrest **SHOULD NOT** create a gap between vehicle seat and booster seat.
- The front of booster seat **MUST NOT** hang over front of vehicle seat.
- If child will not keep vehicle belt properly positioned, **DO NOT** use this booster seat. Use a different car seat.

The AAP recommends that children should use the built-in harness system for as long as possible until they reach the maximum forward-facing weight and height for their car seat. This car seat can remain forward-facing using the built-in harness system for children up to 65 lb (30 kg) and 49" (125 cm).

\* Check your state laws and the AAP/NHTSA recommendations.



***Never Use a Vehicle Lap-Only Belt Across Front of Child***

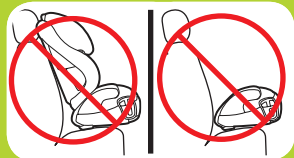
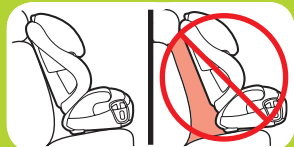

**4 Booster**

## 4-B Install Backed Booster

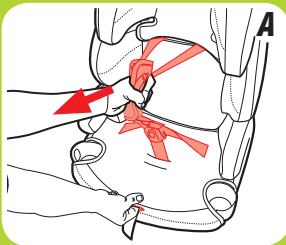

### 1. Remove The Harness System

#### A. Loosen Harness Straps

(A) Push down on the harness release lever while pulling out on the harness straps.

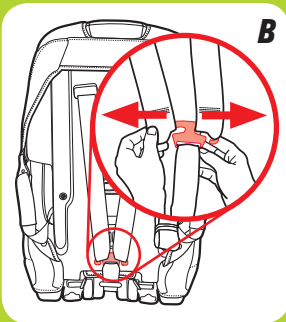

#### B. Remove Straps From Metal Splitter Plate

Face the rear of the seat and remove the belt straps from metal splitter plate as shown.



4 Booster

### ***C. Remove the Buckle Strap and Harness Straps***

From bottom of car seat, rotate metal retainers to side in order to push them through slot easier.

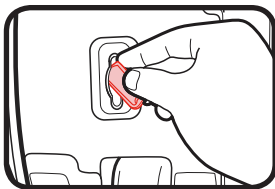

### ***D. Pull Restraint System Out of the Seat***

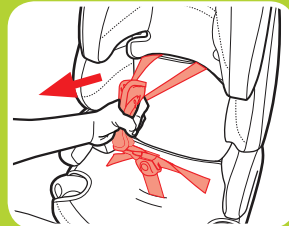
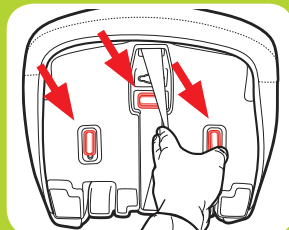

### ***E. Push on Back Support to Release and Remove***

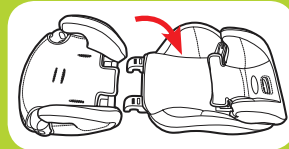

  
4 Booster

4 Booster

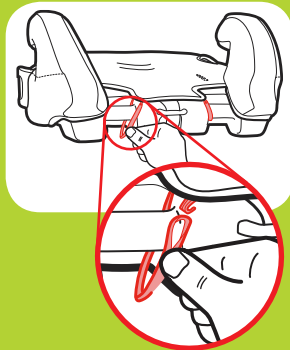
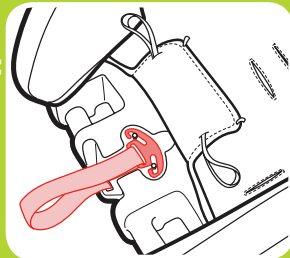

***F. Detach Lower Seat Elastic Straps***

On the rear of the seat, detach 2 lower seat pad elastic straps from hooks as shown.

***G. Store Metal Splitter Plate***

On the rear of the seat, lift the flap and fit the splitter plate into the holder. Pull the adjustment strap to tighten in place.

## **H. Attach Seat Elastic Straps**

Attach 2 elastic straps onto the hooks on the rear of the seat as shown.

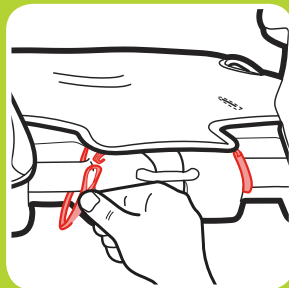

## **I. Place Seat Back Hooks Into Gutters and Raise Seat Back**

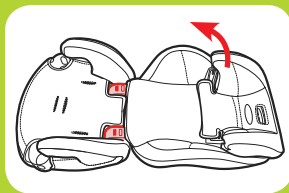

**4 Booster**

## 4 Booster

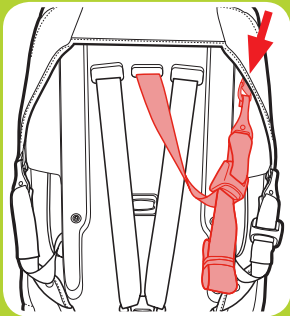

### **2. Unhook Tether From Storage location and Lay it in the Seat**

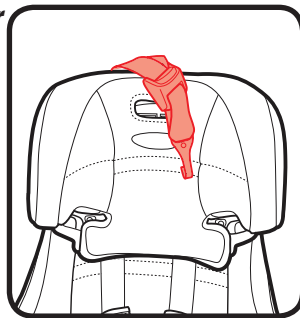

### **3. Place Car Seat Forward-Facing in Back Seat of the Vehicle**

Place forward-facing in vehicle seat. The bottom of the seat should sit as flat as possible on the vehicle seat.



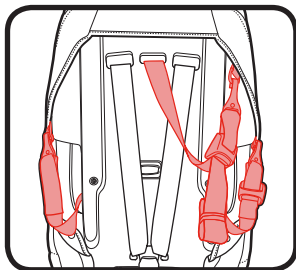

Graco allows the securing of the car seat with LATCH system in the booster mode, only if the vehicle manufacture allows it. The child still **MUST BE SECURED** with the vehicle lap/shoulder seat belt. LATCH can be used in the booster mode regardless of the weight of the child up to 100 lb (45 kg).

Verify the following before using LATCH in the booster mode:

- The LATCH hook **DOES NOT** interfere with any vehicle seat belts or buckles.

If the LATCH interferes with the vehicle seat belts or if the chosen seating position does not have LATCH bars, you **MUST** store the

LATCH strap. Always secure car seat with LATCH or a vehicle seat belt, even when unoccupied. In a crash, an unsecured car seat can injure passengers.

### ***Skip to Step 9 if Not Using LATCH***

#### **4. Extend the LATCH Strap.**

For easier installation, extend the LATCH strap to its maximum length by pressing the grey button and pull out on the strap.

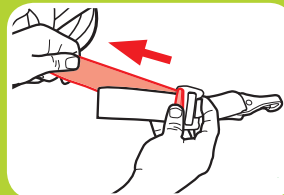

  
**4 Booster**

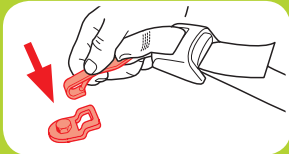
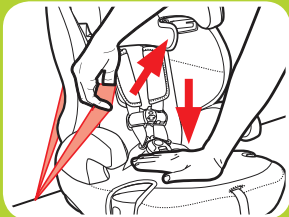
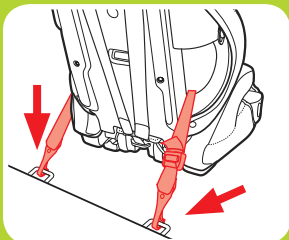

## 5. Attach **LATCH** Hooks to Vehicle's Lower Anchors.

Lower Anchor strap should not be twisted.

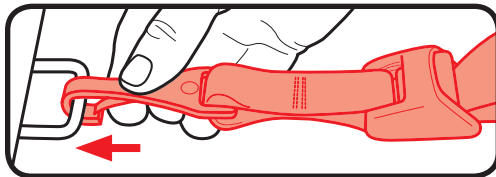

## 6. Tighten the **LATCH** Strap

Remove all the slack from the LATCH strap

## 7. Attach The Tether

Extend the tether by pressing the grey button and pulling out on the strap and attach.

Consult vehicle's owner manual for specific location.

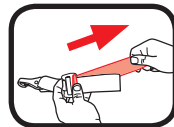

## **8. Tighten Tether**

Remove all the slack.

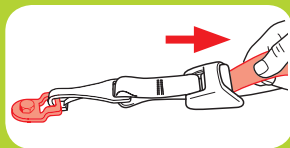

## **9. Thread the Vehicle Seat Shoulder Belt Through Seat Belt Guide on the Headrest**

See section 5-B to secure your child.



  
4 Booster

## 4-C Install Backless Booster

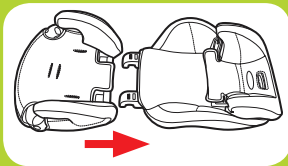

### **1. Remove the Back Support**

See section 4-B for instructions on how to remove back support.

Once back support is removed, store with harness straps in a safe place.

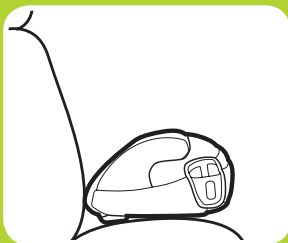

### **2. Place the Booster Seat Forward-Facing in the Back Seat of Vehicle**

Place forward-facing on a vehicle seat that has a lap/shoulder seat belt. The base should sit as flat as possible on the vehicle seat.

**See section 5-C to secure your child.**



## ! WARNING!

**WARNING!** In cold weather, do not put snowsuits or bulky garments on your child when placing them in the car seat. Bulky clothing can prevent the harness straps from being tightened properly. To keep child warm, buckle your child in the car seat and place a blanket around the child or place the child's coat on backwards after buckling in.



## 5-A Securing Child 5-Point Harness

### 1. Loosen Harness Straps

**(A)** Push down on the harness release lever while pulling out on the harness straps at the chest clip.

**(B)** Unbuckle the chest clip and the buckle strap. **(C)** Place harness straps off to the sides.

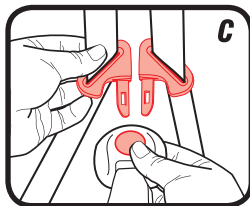

53

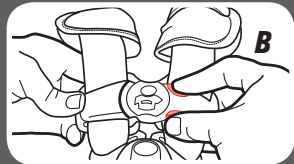
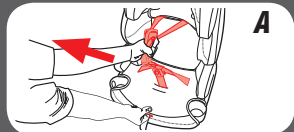

5 Securing  
Child

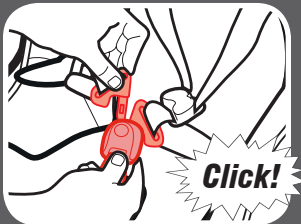
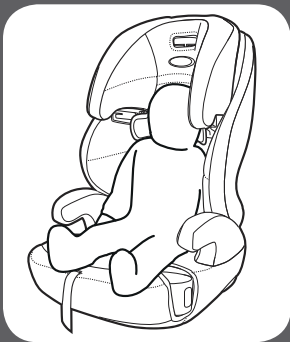

## **2. Place Your Child in the Seat**

Make sure their back is flat against the car seat back.

## **3. Place Harness Straps Over Child's Shoulders and Buckle**

You will hear a “click” when buckle tongues are securely attached. Pull up on each buckle tongue to make sure it is securely attached.

#### 4. **Be Sure the Harness Straps Are at the Proper Height**

**Forward-Facing:** Harness straps must be **at or just above** the child's shoulders and top of child's ears must be **below** top of headrest.

#### 5. **To Raise or Lower Headrest/Harness**

Lift adjustment lever and lift or lower headrest for the proper harness height.

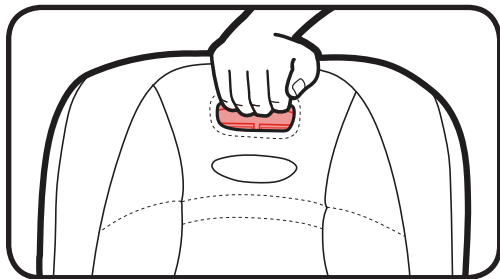

55

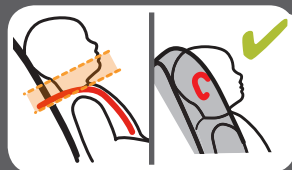

**Forward-Facing**

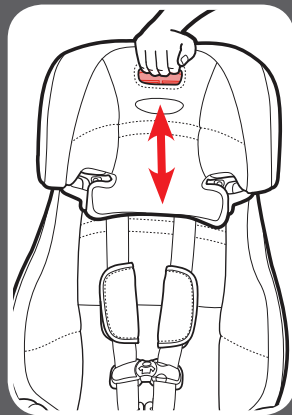

5 Securing  
Child



## 5 Securing Child

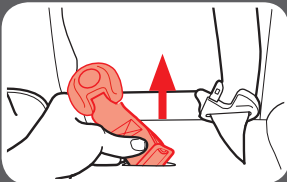
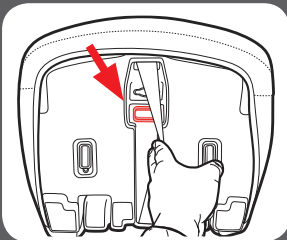
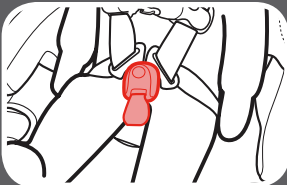

### **6. Check the Buckle Position**

The correct slot is the one that is closest to your child without being underneath your child.

### **7. Remove the Buckle Strap**

From bottom of car seat, rotate metal retainer to side in order to push it through slot easier.

### **8. Pull buckle strap from child restraint as shown.**



**9. Insert Metal Retainer in the New Buckle Strap Slot**

Reach underneath the car seat and pull the metal retainer through.

**10. Pull Up on Buckle Strap to Make Sure it is Secured**

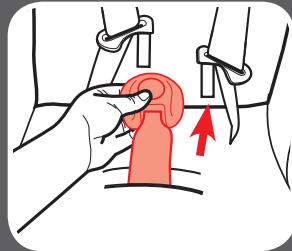
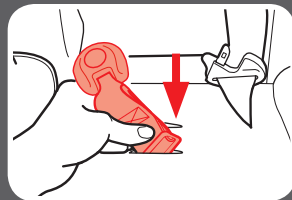

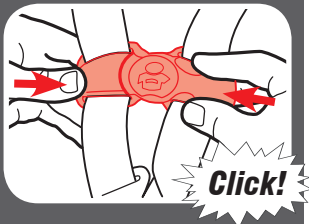

### **11. Buckle the Chest Clip**

You will hear a “click” when the chest clip is securely buckled.

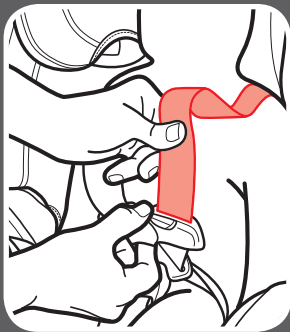

### **12. Pull All the Slack Out From Around the Waist**

Pull up on the harness strap while pushing the chest clip down. Do this to both sides.

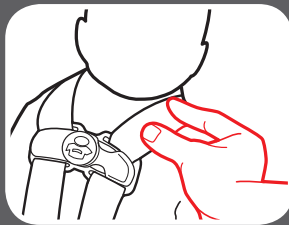
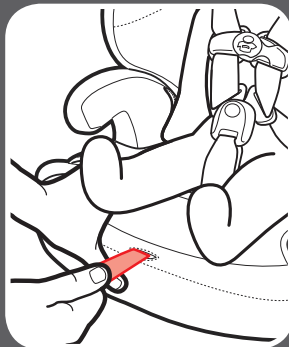

### **13. Tighten the Harness by Pulling the Harness Adjustment Strap**

A snug harness should not allow any slack. It lies in a relatively straight line without sagging. It does not press on the child's flesh or push the child's body into an unnatural position.

When you are not able to pinch any of the harness webbing at your child's shoulder, the harness is tight enough.

**5 Securing  
Child**

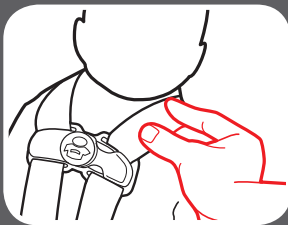
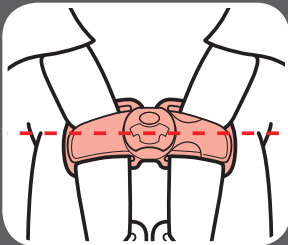

**14. Raise the Chest Clip to Child's Armpit Level**

**15. Check Tightness Again, Tighten More if Needed**



## 5-B Securing Child Backed Booster

### **!WARNING!**

**Use only the vehicle lap and shoulder belt system when restraining the child in the booster seat.**

#### **1. Place Child In Seat**

Have your child sit in the booster seat, with his/her back flat against the back of the booster seat.

#### **2. Thread Vehicle's Shoulder Belt Into Seat Belt Guide in the Headrest**

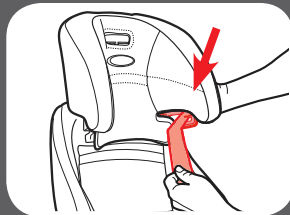
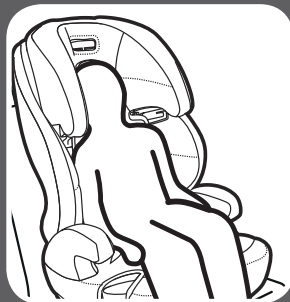

## 5 Securing Child

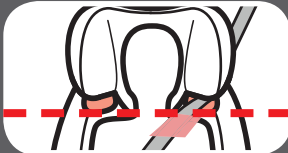
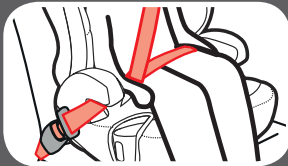

### **3. Buckle the Vehicle Lap/Shoulder Seat Belt**

Be sure the lap portion of the vehicle seat belt goes in front of the armrests.

Be sure the lap portion of the vehicle seat belt lies low across your child's hips.

Be sure the shoulder belt lies across your child's shoulders, between the neck and edge of shoulder. The belt guides should be even with or just above the shoulders.

## *Is Everything Correct?*

### ***Never Use Lap Belt Only***

***Lap Belt in Front of Armrest and Lies Low Across Hips and Thighs***

***Shoulder Belt Lies On the Shoulder, Between the Neck and Edge of Shoulders***

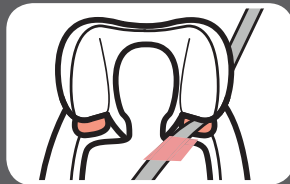



5 Securing  
Child

## 5-C Securing Child Backless Booster

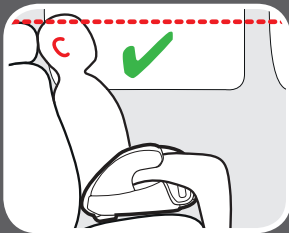

### **! WARNING!**

**Use only the vehicle lap and shoulder belt system when restraining the child in the booster seat.**

#### **1. Place Child In Seat**

Have your child sit in the booster seat, with his/her back flat against the back of the vehicle seat.

#### **2. Ears Must Be Below the Top of the Vehicle Seat Back or Headrest.**



### **3. Buckle the Vehicle Lap/Shoulder Seat Belt**

Be sure the lap portion of the vehicle seat belt goes in front of the armrests.

Be sure the lap portion of the vehicle seat belt lies low across your child's hips.

Be sure the shoulder belt lies across your child's shoulders, between the neck and edge of shoulder.

**You may need to use the belt positioning clip to help get a good fit. See "Using Belt Positioning Clip"**

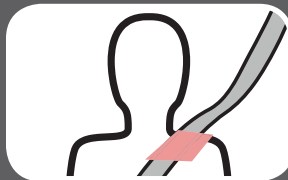
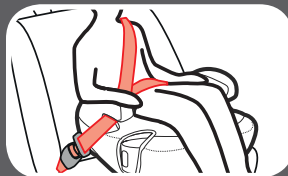



**5 Securing  
Child**

***Is Everything Correct?***



***Never Use Lap Belt Only***



***Lap Belt in Front of Armrest and Lies Low Across Hips and Thighs***

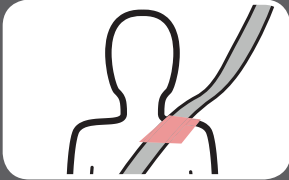

***Shoulder Belt Lies On the Shoulder, Between the Neck and Edge of Shoulders***



## Using Belt Positioning Clip

### 1. Make Sure Vehicle's Seat Shoulder Belt Lays in the Red Zone As Shown

If the vehicle's seat shoulder belt lays outside this zone, you **MUST** use the belt positioning clip.

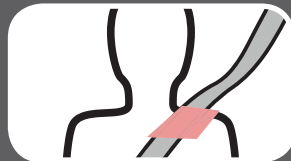

### 2. Attach Belt Positioning Clip

The shoulder belt positioning clip **MUST** be attached to the slot on the bottom of the base. Insert the loop end of strap through the slot on bottom of seat exactly where shown.

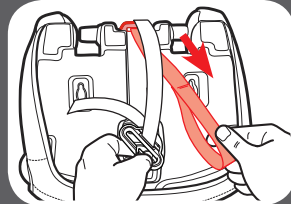

### 3. Push Clip and Strap Through Loop

Pass the clip and the strap through the loop end as shown and pull strap up.

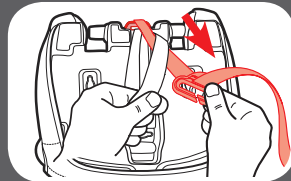

## 5 Securing Child

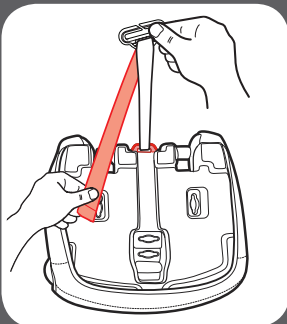

### **4. Free End of Strap Should Face Front of Seat**

### **5. Place Child in Seat, Buckle Child In Seat and Attach Belt Positioning Clip**

With child's back flat against the back of the vehicle seat, buckle child in. Then slide the clip onto the vehicle's seat shoulder belt as shown.

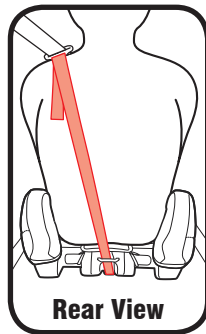



## 6. Adjust the Belt Positioning Clip to Fit Your Child

Lengthen or shorten the belt length as shown.

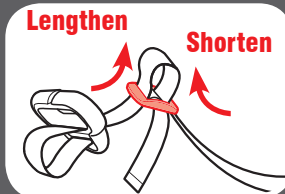

Clip should fit right at the top of shoulder as shown.

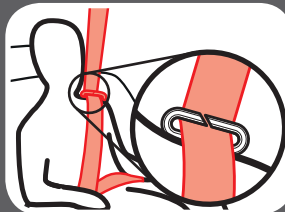

Be sure the lap portion of the vehicle seat belt lies low across your child's hips.

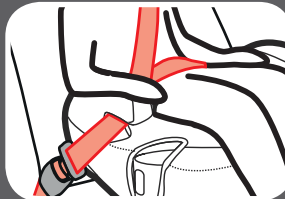

## 6-A Accessories *(on select models)*

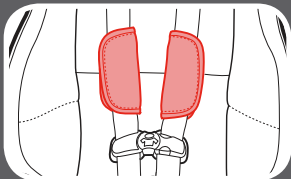

### ***Harness Covers***

Make sure that harness covers do not interfere with placement of the chest clip at armpit level.

To remove, undo the fastening strips and remove.

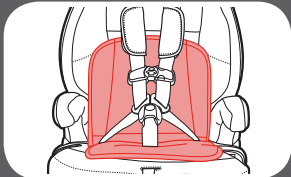

### ***Body Support***

The optional body support may be used in all harnessed modes. To remove, thread buckle through pad.

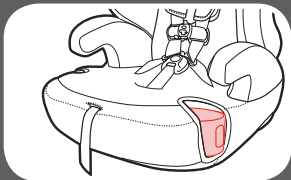

### ***Cup Holder***

Refer to section 2-A to install cup holder.

## 7-A How to Remove LATCH and Top Tether

### **LATCH**

To remove, press the grey button and pull out on the strap to release the tension. Press in on the hook's spring. Push hook in, lift hook up, twist and pull out away from anchor point.

### **Top Tether**

To remove, press the grey button and pull out on the strap to release the tension.

Press in on the hook's spring. Push tether hook in, then lift up and pull away from tether anchor.

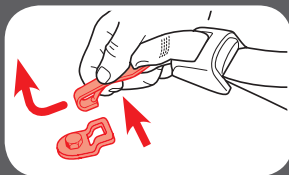
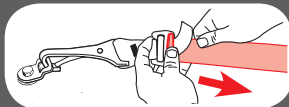
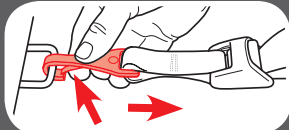
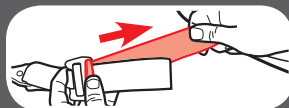

## 7-B Choosing Vehicle Seat Location

*Review your vehicle's owner manual for Seating Locations*

***The best seating location for this car seat is one that:***

- Is recommended by your vehicle owner's manual, and
- Results in a secure installation of this car seat

In the event there is no available back seat and / or you have no other option, the National Highway Traffic Safety Administration (NHTSA) recommends that you take the following steps:

- Ensure the child is properly restrained according to their age and size
- Move the seat as far back as possible
- Make sure the child is not leaning out of position, such as leaning forward into the deployment path of the air bag
- Set the air bag ON-OFF switch, if available, to the OFF position





## 7-C Unsafe Vehicle Seat Location

Never install this car seat in any of the following vehicle seating locations:



rear-facing or side-facing vehicle seats



rear-facing with an active front air bag



booster mode with vehicle lap belt only seat belt



## 7-D Vehicle Seat Belts

*Review your vehicle's owner manual for vehicle seat belt use*

This car seat can be installed using a vehicle seat belt. To do this, you will need to change the seat belt to a locked mode for use with car seats. With some vehicle seat belts, this is done with the latchplate; with other vehicle seat belts, this is done with the retractor.

### *Vehicle Seat Belt Terms*

#### **Retractor**

A device that winds up the unused vehicle seat belt. It is often hidden inside the panels on the walls of the vehicle or in the vehicle seatback.

#### **Latch Plate**

The male end of the seat belt with the silver tongue.

#### **Seat Bight**

The crease where the vehicle seat back and seat bottom meet.

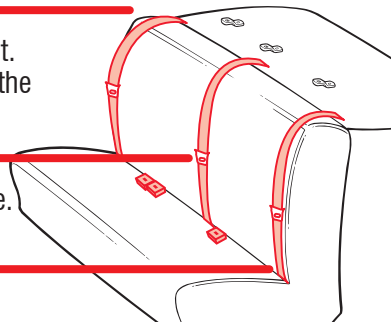

## Identify Your Seat Belt Type

There are two different types of vehicle seat belts that can be used with this car seat:

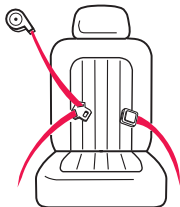

**Lap/Shoulder Belt**  
3 connections points.  
Can be used in all car  
seats modes of use.

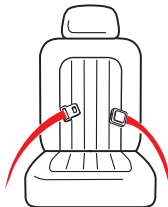

**Lap Belt Only**  
2 connection points. **Can  
ONLY be used in harness  
mode.**

The following types of vehicle seat belts **CANNOT** be used safely with this car seat:



Lap Belt with Motorized  
Shoulder Belt



Lap Belt or Shoulder  
Belt Mounted on Door

Belts Forward of the  
Seat Bight

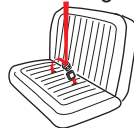

Some vehicles you may not get a  
secure fit. Read both your vehicle  
and car seat manuals.



## Lap/Shoulder Belt Installation - Forward Facing Modes

**Always review your vehicle owner's manual for specific information about your vehicle seat belts.**

There are three types of retractors: **ELR (Emergency Locking Retractor)**, **ALR (Automatic Locking Retractor)**, and **Switchable (ELR switch to ALR)**. To determine your type of retractor, follow these steps:

1. **Slowly** pull the belt out about halfway and stop.
2. Let the belt retract back several inches.
3. Try to **slowly** pull the belt out more. If the belt cannot be pulled any further, it is **ALR**. If it can be pulled further, go to the next step.
4. **Slowly** pull the belt all the way out, and then allow it to retract several inches.
5. Try to pull the belt all the way out again. If it cannot be pulled out, it is **Switchable**. If it can still be pulled out freely, it is **ELR**.

**Note:** Most vehicles manufactured after 1996 will have Switchable retractors in the back seat. If you have any questions about your retractor type, consult your vehicle owner's manual or call Graco for assistance.

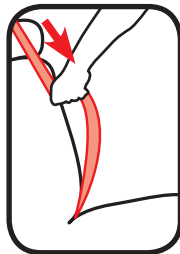

## How to Lock Your Lap and Shoulder Vehicle Seat Belt

### Sliding Latch Plate and Switchable Retractor

A latchplate that slides freely on the belt webbing and cannot, by itself, hold the belt snug around a car seat.

When installing the car seat, route the vehicle seat belt through the proper belt path and buckle it in. **Slowly pull the shoulder belt all the way out to switch it to locking mode.** Then, as you pull the vehicle seat belt tight, feed all the slack back into the retractor.

Grab the sides of the seat at the belt path and slide the seat side-to-side and front-to-back. The seat should not move more than 1" (2.5 cm).

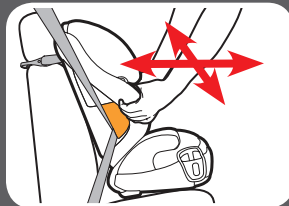
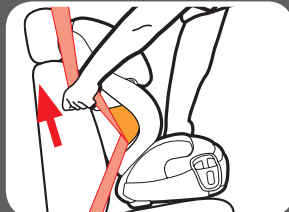

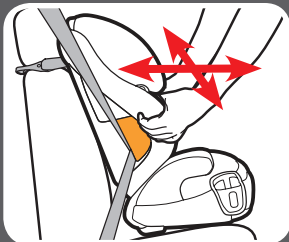
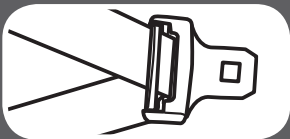

### ***Locking Latchplate and ELR Retractor***

A latchplate that holds the lap belt snug after it has been adjusted; contains a metal bar on the underside of the hardware that “locks” the belt in position.

When installing the car seat, route the vehicle seat belt through the proper belt path and buckle it in. Then, pull upwards on the shoulder belt so that the lap belt gets tight around the car seat.

Grab the sides of the seat at the belt path and slide the seat side-to-side and front-to-back. The seat should not move more than 1” (2.5 cm).

## ***Sliding Latch Plate and ALR Retractor***

A latchplate that slides freely on the belt webbing and cannot, by itself, hold the belt snug around a car seat.

**Slowly pull the shoulder belt all the way out.** Route the vehicle seat belt through the proper belt path and buckle it in. Then, as you pull the vehicle seat belt tight, feed all the slack back into the retractor.

Grab the sides of the seat at the belt path and slide the seat side-to-side and front-to-back. The seat should not move more than 1" (2.5 cm).

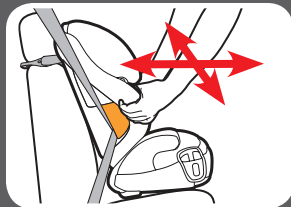
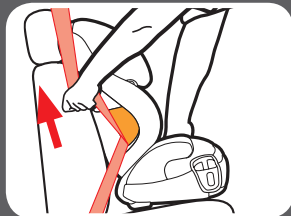

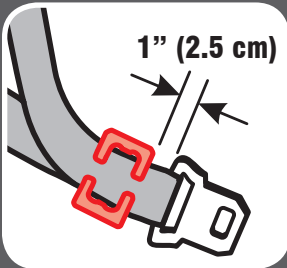
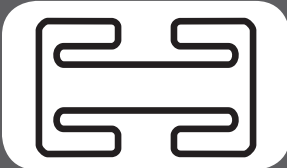
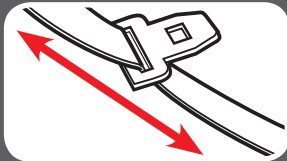

### ***Sliding Latch Plate and ELR Retractor***

A latchplate that slides freely on the belt webbing and cannot, by itself, hold the belt snug around a car seat.

With this retractor, you will need to use the locking clip to lock the vehicle seat belt.

Call us at 1-800-345-4109 to order a locking clip.

Route the vehicle seat belt through the proper belt path and buckle it in. Pull the vehicle seat belt tight. While pushing down on seat, pinch the two straps together behind the buckle tongue. Unbuckle the belt without allowing it to slip.

Attach locking clip to lap and shoulder belts as shown.

Rebuckle belt. Check that lap belt does not move by pulling hard. If belt loosens or lengthens, repeat procedure.



## Lap Belt Installation - DO NOT use in Booster Mode

Always review your vehicle owner's manual for specific information about your vehicle seat belts.

### Locking Latch Plate and No Retractor

When installing the car seat, route the lap seat belt through the proper path and buckle it in. Then, pull upwards on the tail of the belt so that the lap belt gets tight around the car seat.

### Sewn On Latch Plate and ALR

**Slowly pull the lap belt all the way out.** Route the vehicle seat lap belt through the proper belt path and buckle it in. Then, pull the lap belt tight while feeding all the slack back into the retractor.



Grab the sides of the seat at the belt path and slide the seat side-to-side and front-to-back. The seat should not move more than 1" (2.5 cm).

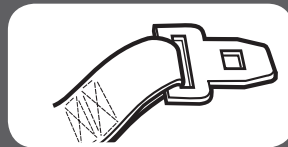

## 8-A Cleaning Seat Pad

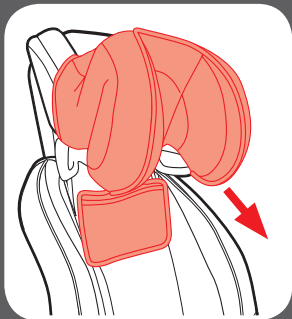

Refer to seat pad care tag for washing instructions.

### ***Headrest Cover***

Clean with a damp sponge using mild soap and cool water. If needed, headrest cover may be removed for cleaning.

Remove harness and buckle strap. See section 4-B.

Remove headrest cover as shown.

Machine wash cover in cold water on delicate cycle and drip-dry. **DO NOT USE BLEACH.**

## Seat Cover

Clean with a damp sponge using mild soap and cool water. If needed, seat cover may be removed for cleaning.

To remove, unbutton snaps on seat back as shown.

Remove harness and buckle strap. See section 4-B.

Remove seat cover as shown.

Machine wash cover in cold water on delicate cycle and drip-dry. **DO NOT USE BLEACH.**

Reverse the steps to reattach the seat cover.

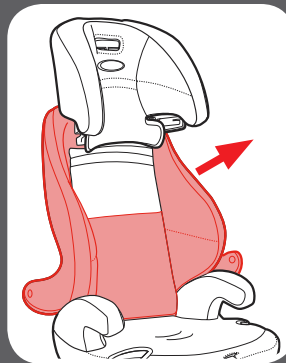
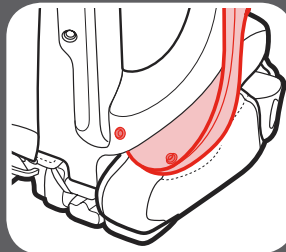

## 8 Care & Cleaning

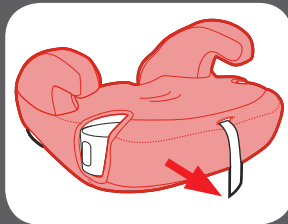
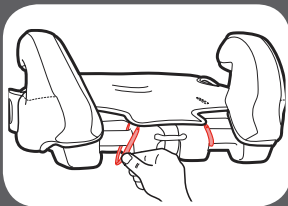
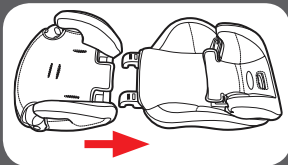

See section 4-B for instructions on how to remove back support.

On the rear of the seat, detach 2 lower seat pad elastic straps from hooks as shown.

Remove seat cover as shown.

## 8-B Cleaning Buckle Strap

From bottom of car seat, rotate metal retainer to side in order to push it through slot easier. Pull buckle strap from child restraint as shown.

To clean buckle, place in a cup of warm water and gently agitate the buckle. Press the red button several times while in the water.

**DO NOT SUBMERGE THE BUCKLE STRAP.** DO NOT USE SOAPS, HOUSEHOLD DETERGENTS or LUBRICANTS.

Shake out excess water and allow to air dry. Repeat steps as needed until it fastens with a click. Re-insert the buckle into the same slot it was removed. Pull on buckle strap to make sure it is secured.

**WARNING!** Inspect and clean buckle from time to time to remove any objects or debris that could prevent latching.

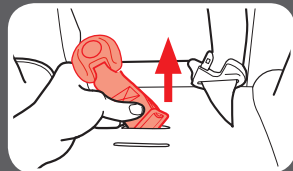
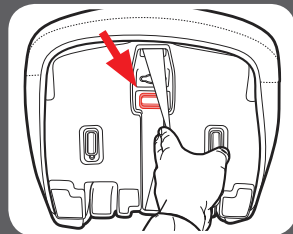



## 8-C Cleaning Harness and LATCH Straps

Surface wash only with mild soap and damp cloth. **DO NOT IMMERSE THE HARNESS STRAPS or LOWER ANCHOR STRAP IN WATER** Doing so may weaken the straps.

If harness straps or lower anchor strap are frayed or heavily soiled, contact Customer Service at [www.gracobaby.com](http://www.gracobaby.com) or 1-800-345-4109.

# Notes

## Replacement Parts

To purchase parts or accessories in the United States,  
please contact us at the following:

**[www.gracobaby.com](http://www.gracobaby.com)**

or

**1-800-345-4109**

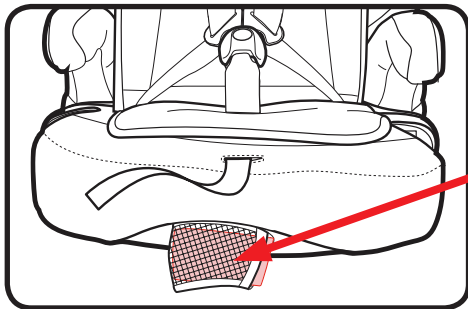

Store instruction manual in  
the pouch with the instruction  
book icon as shown.