

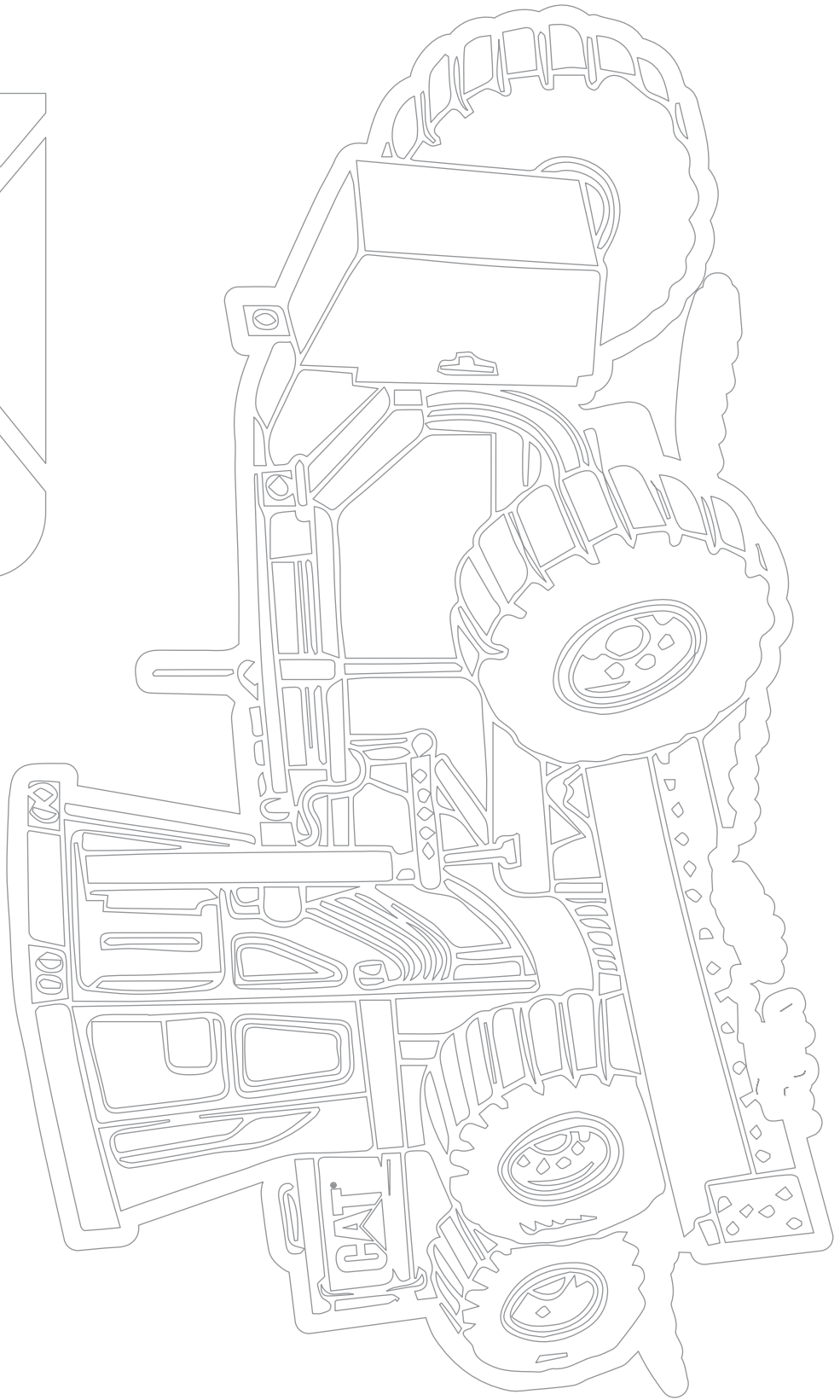

# CAT



© 2019 Caterpillar. All Rights Reserved.  
 CAT, CATERPILLAR, LET'S DO THE WORK, their  
 respective logos, "Caterpillar Yellow", the "Power  
 Edge" and Cat "Modern Hex" trade dress as well  
 as corporate and product identity used herein,  
 are trademarks of Caterpillar and may not be used  
 without permission.  
[www.cat.com](http://www.cat.com) / [www.caterpillar.com](http://www.caterpillar.com)  
 Brush Art Corporation, a licensee of Caterpillar Inc.

Coloring sheets are for internal use only.  
 If you wish to reproduce for other purposes, please contact Darla Hall at Witty Publications  
 at [dhall@wittypublications.com](mailto:dhall@wittypublications.com) to place your order.



Created by Darla Hall, owner of Witty Publications  
 for the Brush Art Corporation.  
[www.wittypubs.com](http://www.wittypubs.com) | © Witty Publications 2019

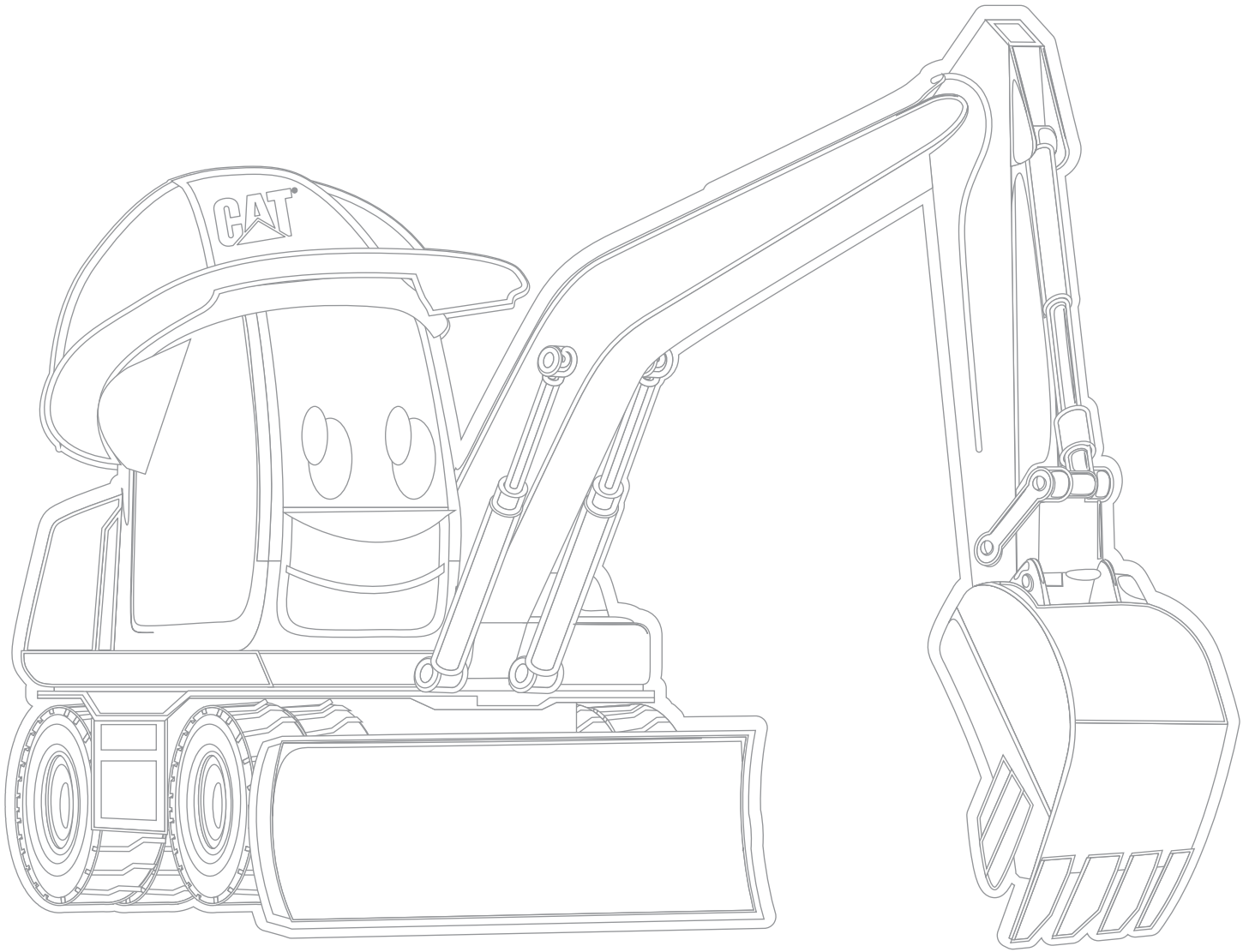

© 2019 Caterpillar. All Rights Reserved.  
CAT, CATERPILLAR, LET'S DO THE WORK, their  
respective logos, "Caterpillar Yellow", the "Power  
Edge" and Cat "Modern Hex" trade dress as well  
as corporate and product identity used herein,  
are trademarks of Caterpillar and may not be used  
without permission.  
[www.cat.com](http://www.cat.com) / [www.caterpillar.com](http://www.caterpillar.com)  
Brush Art Corporation, a licensee of Caterpillar Inc.

Coloring sheets are for internal use only.  
If you wish to reproduce for other purposes, please contact Darla Hall at Witty Publications  
at [dhall@wittypublications.com](mailto:dhall@wittypublications.com) to place your order.



Created by Darla Hall, owner of Witty Publications  
for the Brush Art Corporation.  
[www.wittypubs.com](http://www.wittypubs.com) | © Witty Publications 2019

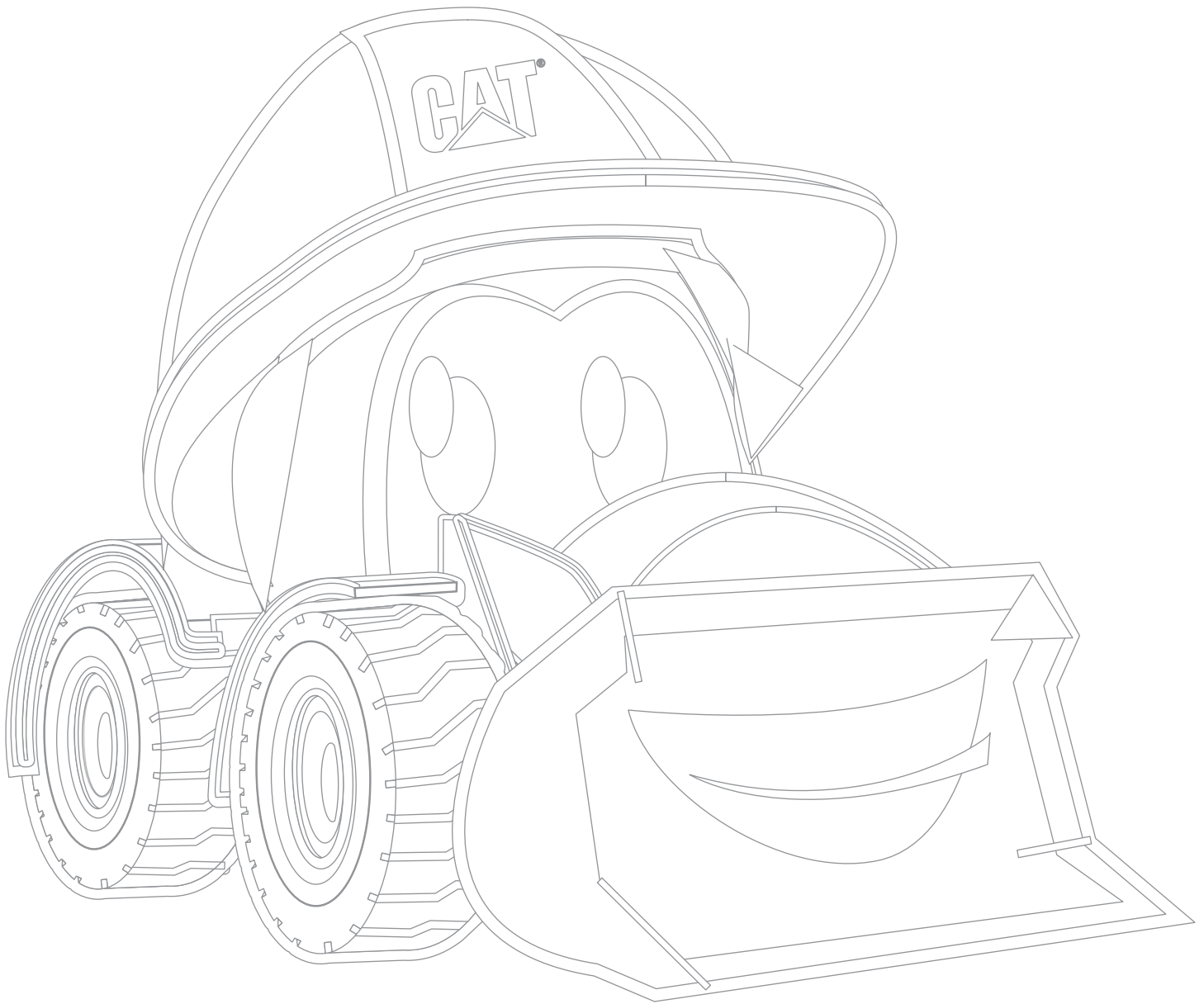

© 2019 Caterpillar. All Rights Reserved.  
CAT, CATERPILLAR, LET'S DO THE WORK, their  
respective logos, "Caterpillar Yellow", the "Power  
Edge" and Cat "Modern Hex" trade dress as well  
as corporate and product identity used herein,  
are trademarks of Caterpillar and may not be used  
without permission,  
[www.cat.com](http://www.cat.com) / [www.caterpillar.com](http://www.caterpillar.com)  
Brush Art Corporation, a licensee of Caterpillar Inc.

Coloring sheets are for internal use only.  
If you wish to reproduce for other purposes, please contact Darla Hall at Witty Publications  
at [dhall@wittypublications.com](mailto:dhall@wittypublications.com) to place your order.



Created by Darla Hall, owner of Witty Publications  
for the Brush Art Corporation.  
[www.wittypubs.com](http://www.wittypubs.com) | © Witty Publications 2019

©  
**CAT**

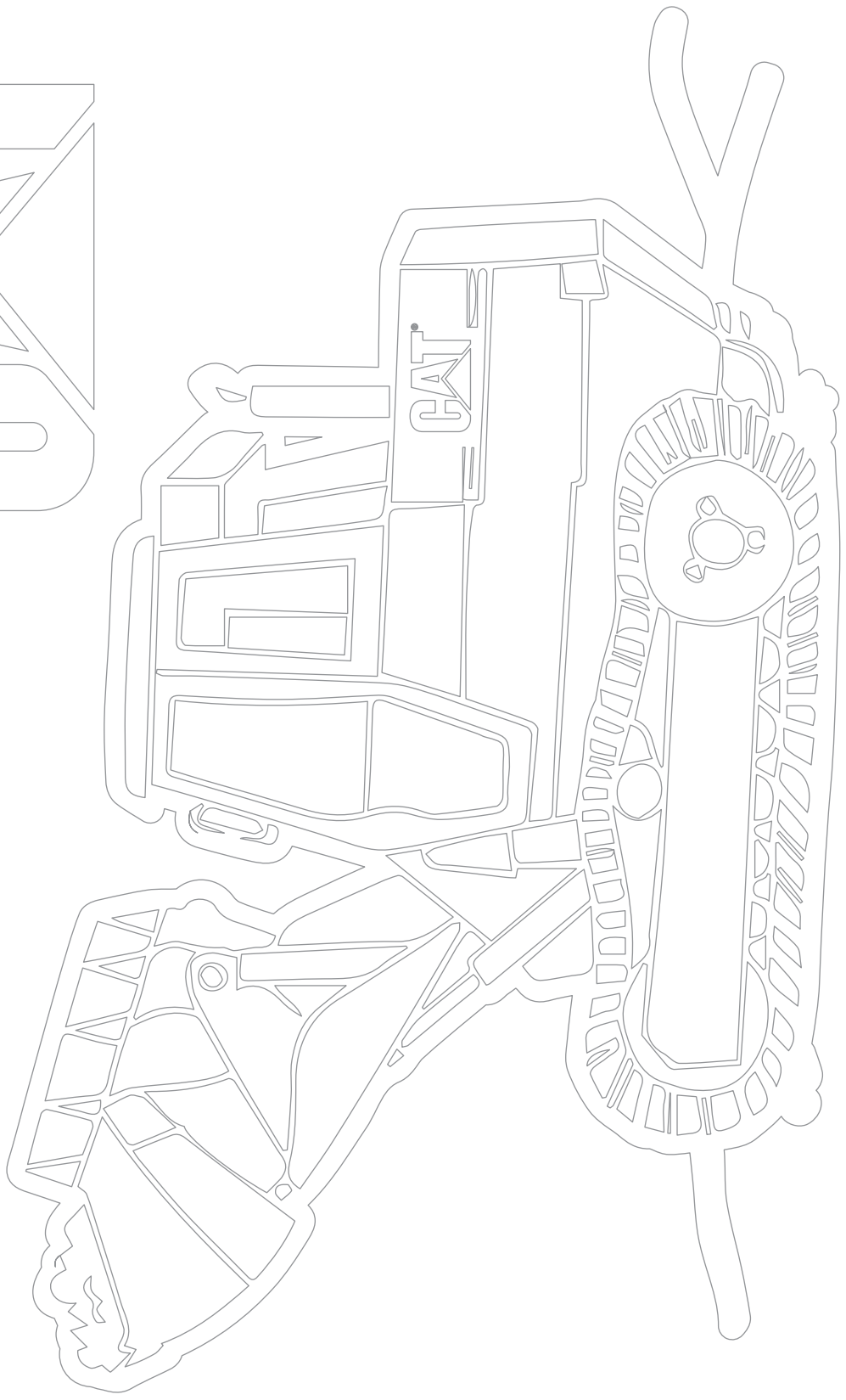

© 2019 Caterpillar. All Rights Reserved.  
CAT, CATERPILLAR, LET'S DO THE WORK, their  
respective logos, "Caterpillar Yellow", the "Power  
Edge" and Cat "Modern Hex" trade dress as well  
as corporate and product identity used herein,  
are trademarks of Caterpillar and may not be used  
without permission.  
[www.cat.com](http://www.cat.com) / [www.caterpillar.com](http://www.caterpillar.com)  
Brush Art Corporation, a licensee of Caterpillar Inc.

Coloring sheets are for internal use only.  
If you wish to reproduce for other purposes, please contact Darla Hall at Witty Publications  
at [dhall@wittypublications.com](mailto:dhall@wittypublications.com) to place your order.



Created by Darla Hall, owner of Witty Publications  
for the Brush Art Corporation.  
[www.wittypubs.com](http://www.wittypubs.com) | © Witty Publications 2019

©  
**CAT**

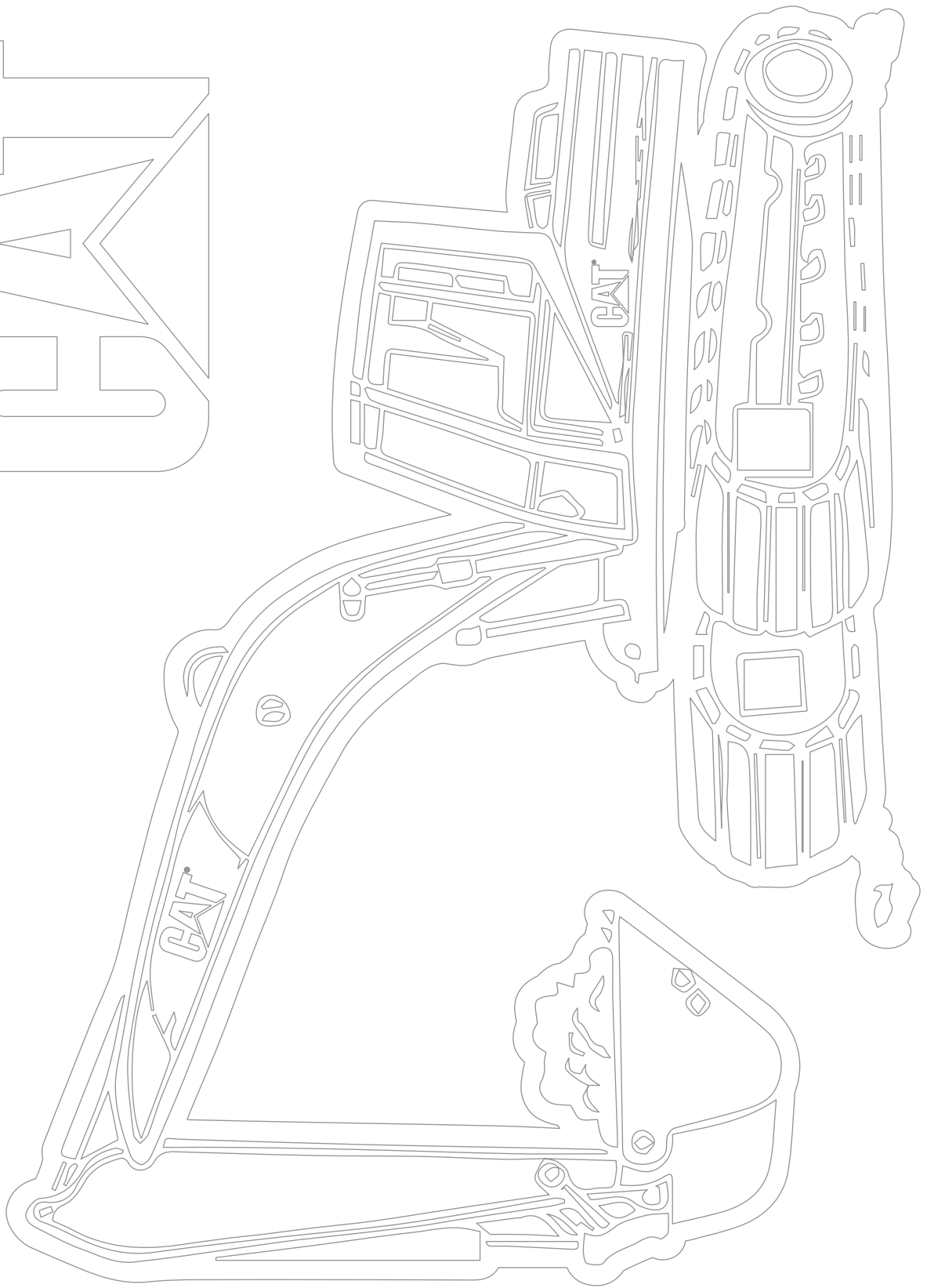

© 2019 Caterpillar. All Rights Reserved.  
CAT, CATERPILLAR, LET'S DO THE WORK, their  
respective logos, "Caterpillar Yellow", the "Power  
Edge" and Cat "Modern Hex" trade dress as well  
as corporate and product identity used herein,  
are trademarks of Caterpillar and may not be used  
without permission.  
[www.cat.com](http://www.cat.com) / [www.caterpillar.com](http://www.caterpillar.com)  
Brush Art Corporation, a licensee of Caterpillar Inc.

Coloring sheets are for internal use only.  
If you wish to reproduce for other purposes, please contact Darla Hall at Witty Publications  
at [dhall@wittypublications.com](mailto:dhall@wittypublications.com) to place your order.



Created by Darla Hall, owner of Witty Publications  
for the Brush Art Corporation.  
[www.wittypubs.com](http://www.wittypubs.com) | © Witty Publications 2019

©  
**CAT**

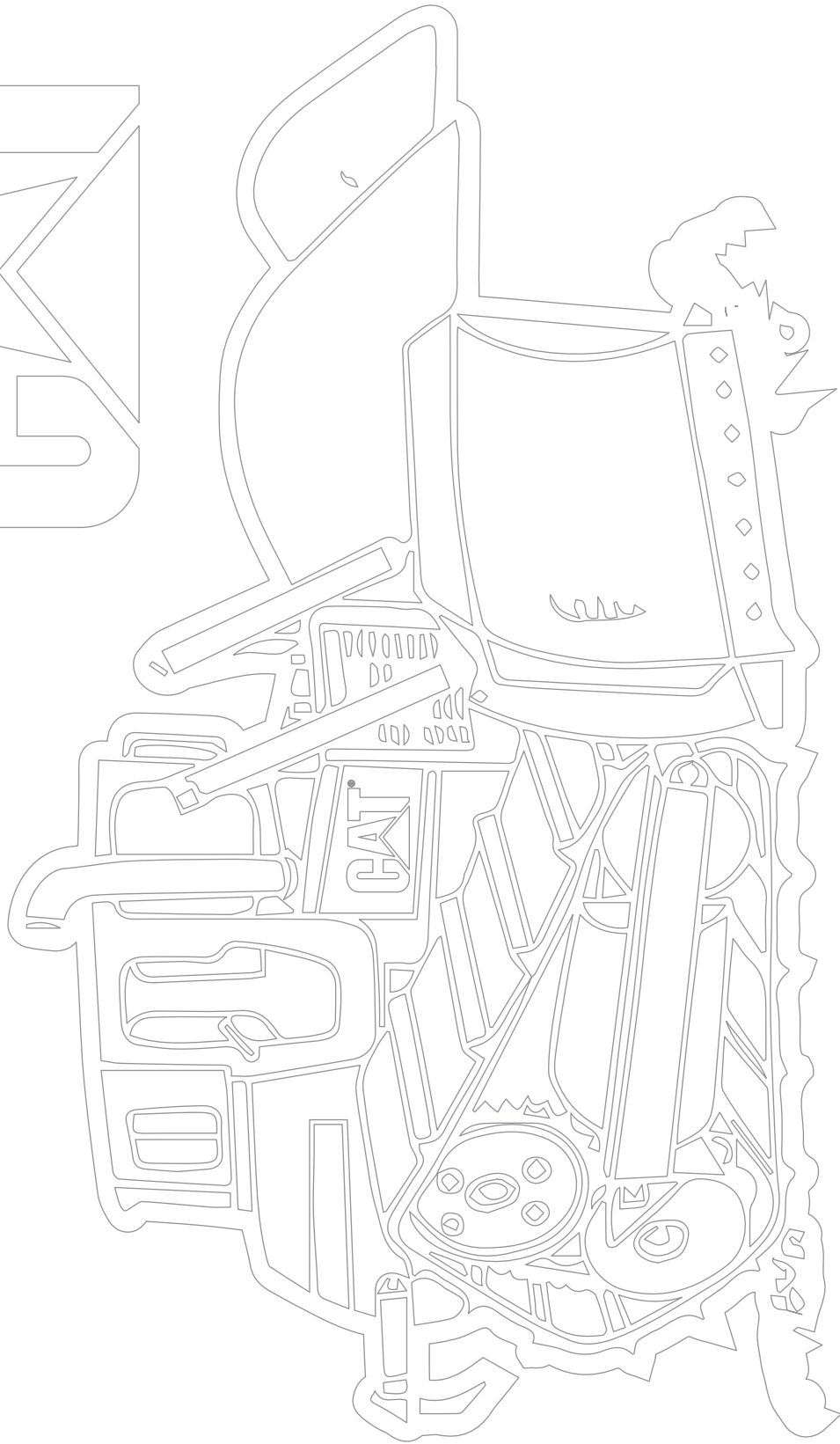

© 2019 Caterpillar. All Rights Reserved.  
CAT, CATERPILLAR, LET'S DO THE WORK, their  
respective logos, "Caterpillar Yellow", the "Power  
Edge" and Cat "Modern Hex" trade dress as well  
as corporate and product identity used herein,  
are trademarks of Caterpillar and may not be used  
without permission,  
www.cat.com / www.caterpillar.com  
Brush Art Corporation, a licensee of Caterpillar Inc.

Coloring sheets are for internal use only.  
If you wish to reproduce for other purposes, please contact Darla Hall at Witty Publications  
at [dhall@wittypublications.com](mailto:dhall@wittypublications.com) to place your order.



Created by Darla Hall, owner of Witty Publications  
for the Brush Art Corporation.  
[www.wittypubs.com](http://www.wittypubs.com) | © Witty Publications 2019

# WHAT DO YOU WANT TO BE WHEN YOU GROW UP?

LOOK IN THE MIRRORS AND DRAW YOURSELF!

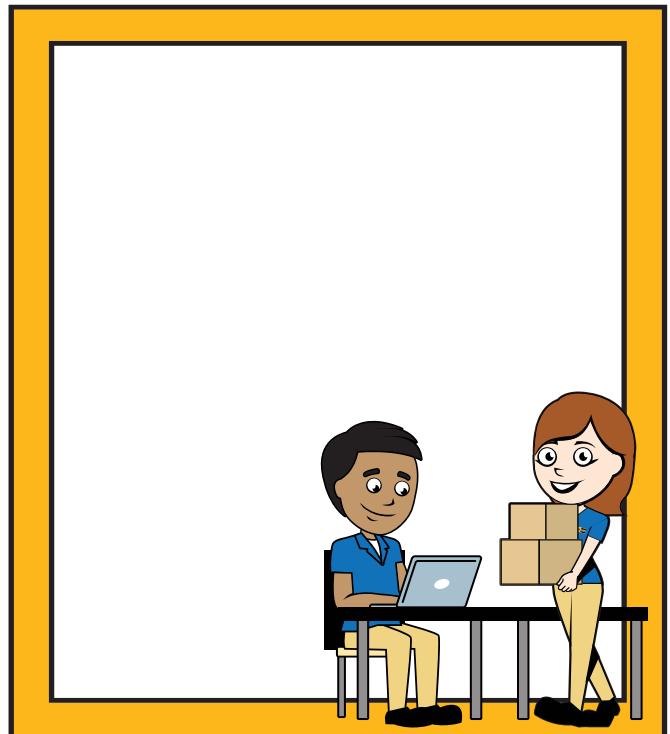
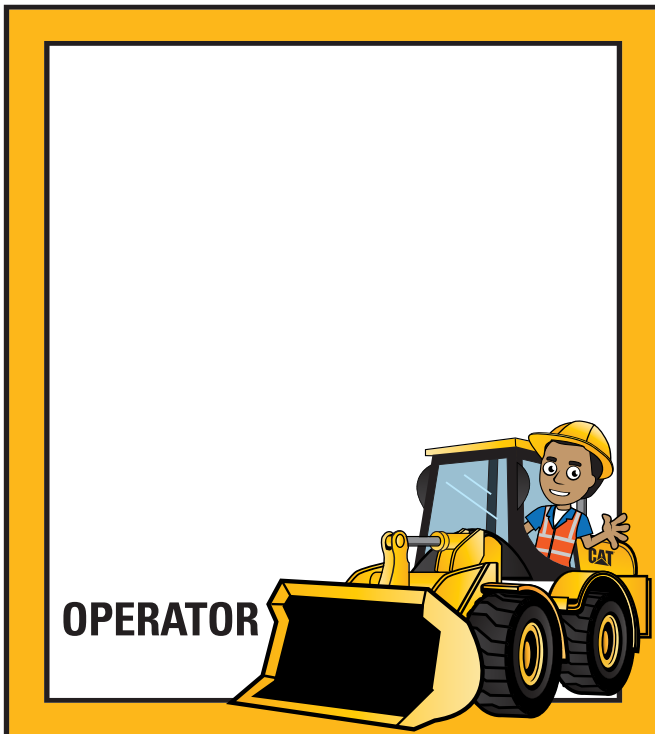
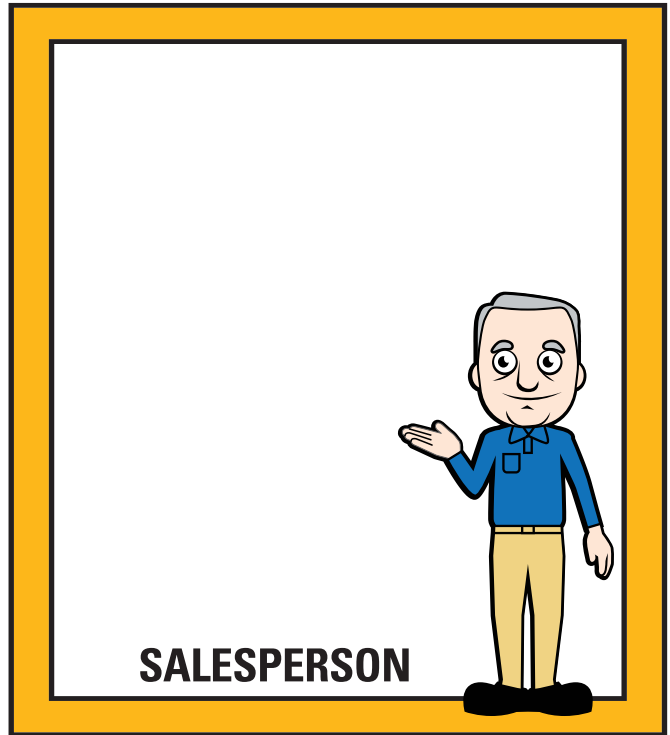
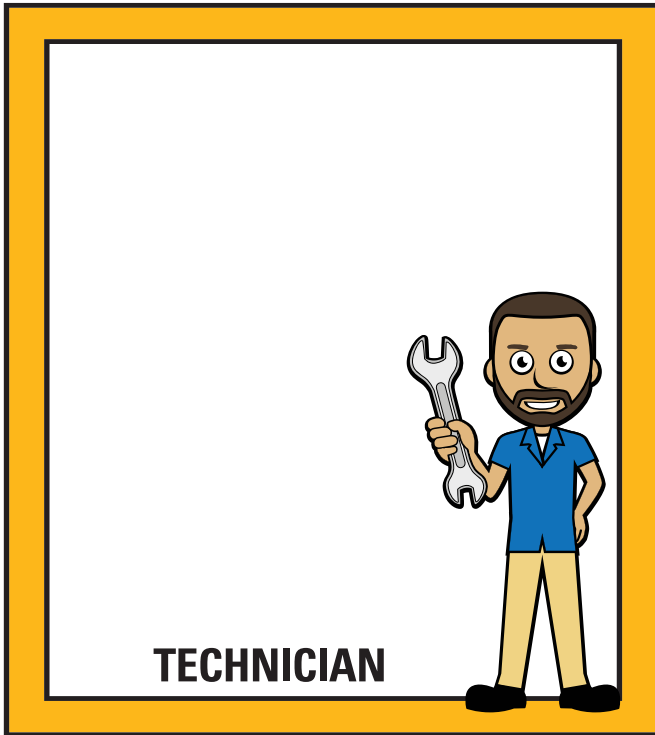

© 2019 Caterpillar. All Rights Reserved.  
CAT, CATERPILLAR, LET'S DO THE WORK, their  
respective logos, "Caterpillar Yellow", the "Power  
Edge" and Cat "Modern Hex" trade dress as well  
as corporate and product identity used herein,  
are trademarks of Caterpillar and may not be used  
without permission.  
www.cat.com / www.caterpillar.com  
Brush Art Corporation, a licensee of Caterpillar Inc.

Coloring sheets are for internal use only.  
If you wish to reproduce for other purposes, please contact Darla Hall at Witty Publications  
at [dhall@wittypublications.com](mailto:dhall@wittypublications.com) to place your order.



Created by Darla Hall, owner of Witty Publications  
for the Brush Art Corporation.  
[www.wittypubs.com](http://www.wittypubs.com) | © Witty Publications 2019

# CAT®

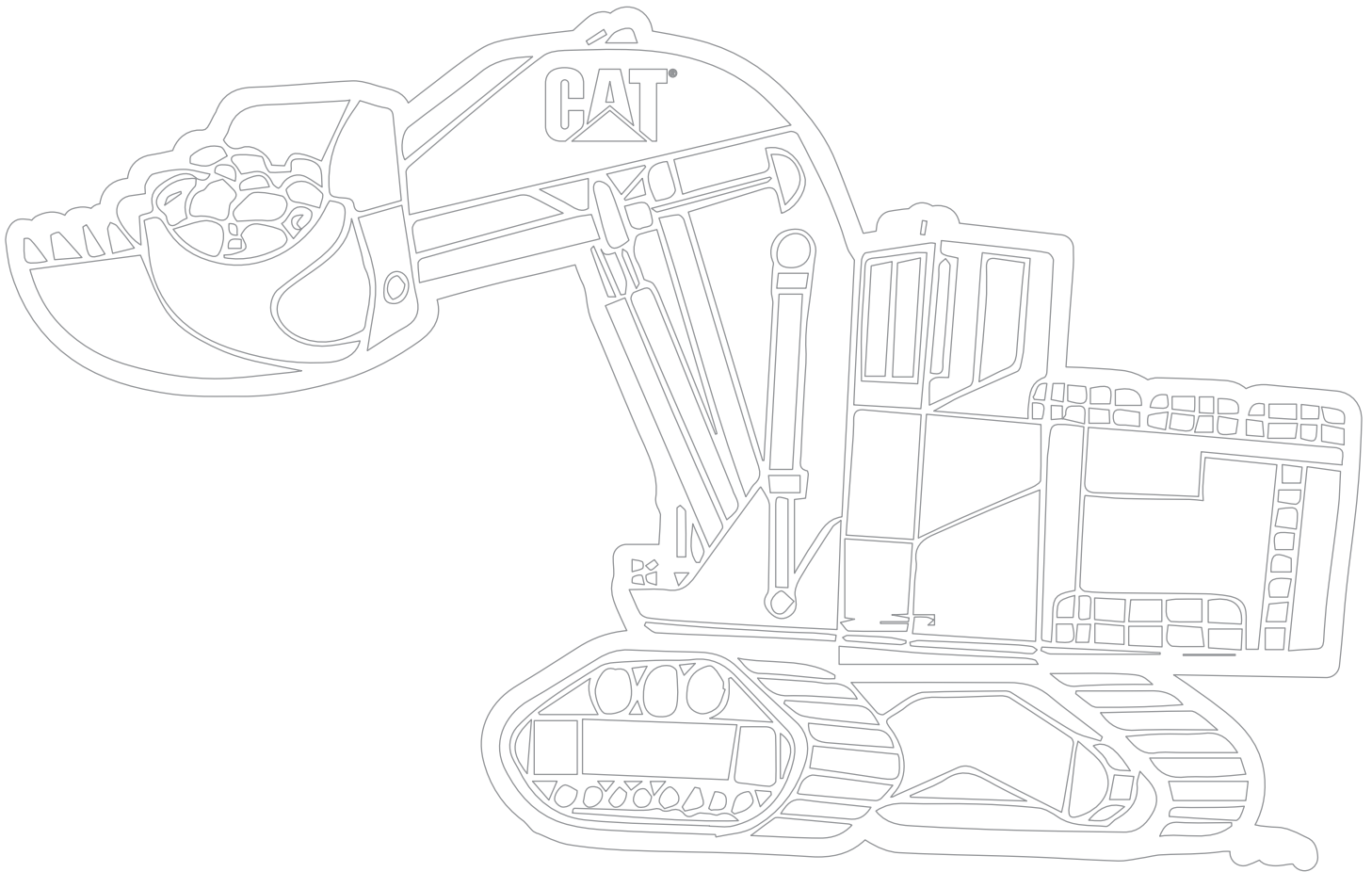

© 2019 Caterpillar. All Rights Reserved.  
CAT, CATERPILLAR, LET'S DO THE WORK, their  
respective logos, "Caterpillar Yellow", the "Power  
Edge" and Cat "Modern Hex" trade dress as well  
as corporate and product identity used herein,  
are trademarks of Caterpillar and may not be used  
without permission.  
[www.cat.com](http://www.cat.com) / [www.caterpillar.com](http://www.caterpillar.com)  
Brush Art Corporation, a licensee of Caterpillar Inc.

Coloring sheets are for internal use only.  
If you wish to reproduce for other purposes, please contact Darla Hall at Witty Publications  
at [dhall@wittypublications.com](mailto:dhall@wittypublications.com) to place your order.



Created by Darla Hall, owner of Witty Publications  
for the Brush Art Corporation.  
[www.wittypubs.com](http://www.wittypubs.com) | © Witty Publications 2019



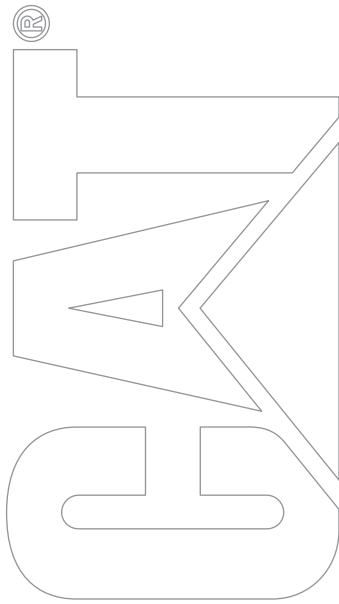
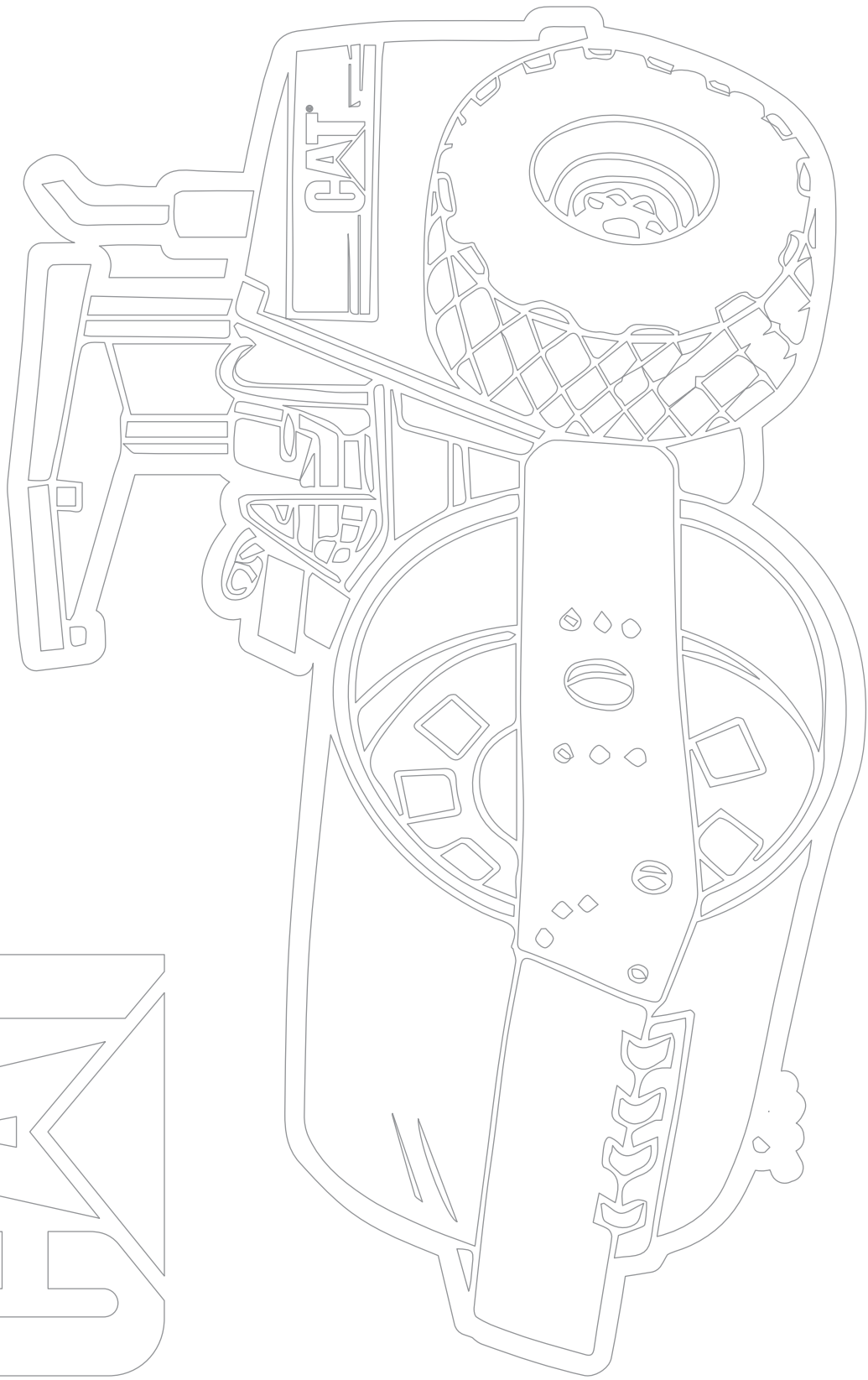

© 2019 Caterpillar. All Rights Reserved.  
CAT, CATERPILLAR, LET'S DO THE WORK, their  
respective logos, "Caterpillar Yellow", the "Power  
Edge" and Cat "Modern Hex" trade dress as well  
as corporate and product identity used herein,  
are trademarks of Caterpillar and may not be used  
without permission.  
[www.cat.com](http://www.cat.com) / [www.caterpillar.com](http://www.caterpillar.com)  
Brush Art Corporation, a licensee of Caterpillar Inc.

Coloring sheets are for internal use only.  
If you wish to reproduce for other purposes, please contact Darla Hall at Witty Publications  
at [dhall@wittypublications.com](mailto:dhall@wittypublications.com) to place your order.



Created by Darla Hall, owner of Witty Publications  
for the Brush Art Corporation.  
[www.wittypubs.com](http://www.wittypubs.com) | © Witty Publications 2019

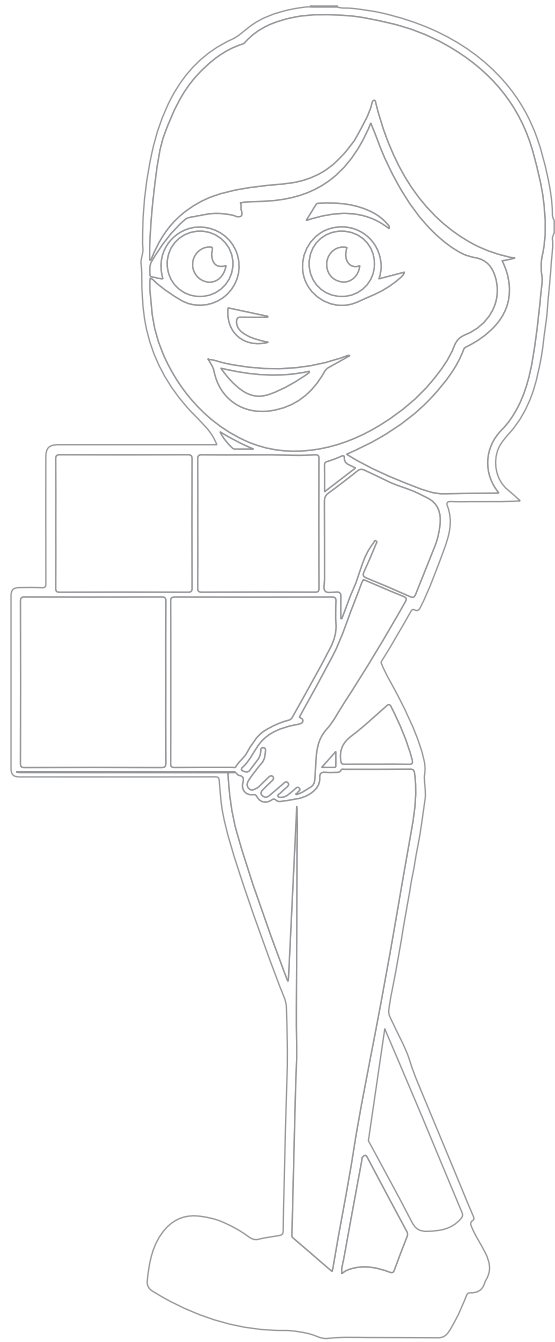
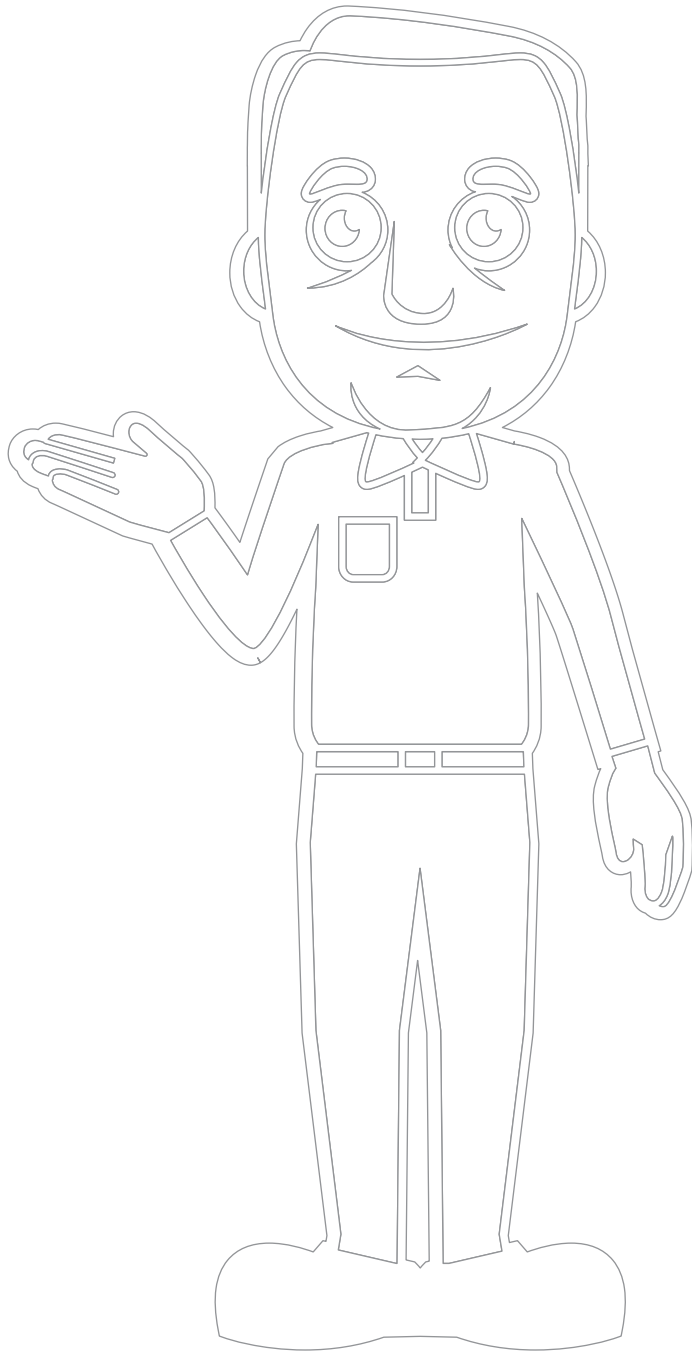

CAT<sup>®</sup>



© 2019 Caterpillar. All Rights Reserved.  
CAT, CATERPILLAR, LET'S DO THE WORK, their  
respective logos, "Caterpillar Yellow", the "Power  
Edge" and Cat "Modern Hex" trade dress as well  
as corporate and product identity used herein,  
are trademarks of Caterpillar and may not be used  
without permission.  
www.cat.com / www.caterpillar.com  
Brush Art Corporation, a licensee of Caterpillar Inc.

Coloring sheets are for internal use only.  
If you wish to reproduce for other purposes, please contact Darla Hall at Witty Publications  
at [dhall@wittypublications.com](mailto:dhall@wittypublications.com) to place your order.



Created by Darla Hall, owner of Witty Publications  
for the Brush Art Corporation.  
[www.wittypubs.com](http://www.wittypubs.com) | © Witty Publications 2019

**CAT**<sup>®</sup>

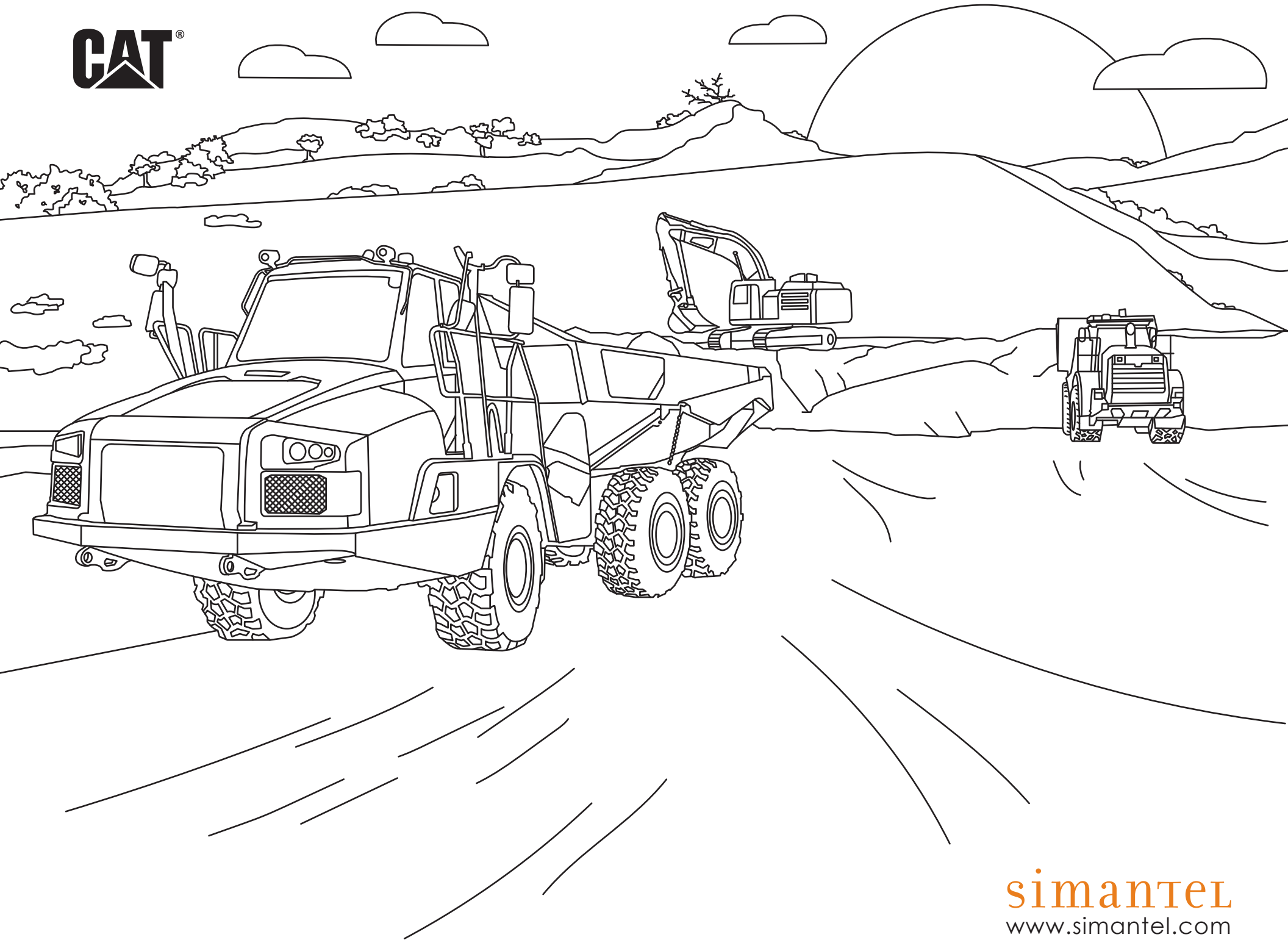

**simantel**  
www.simantel.com

Draw **yourself** into the scene and what **you** see outside the cab windows and in the monitor screens.

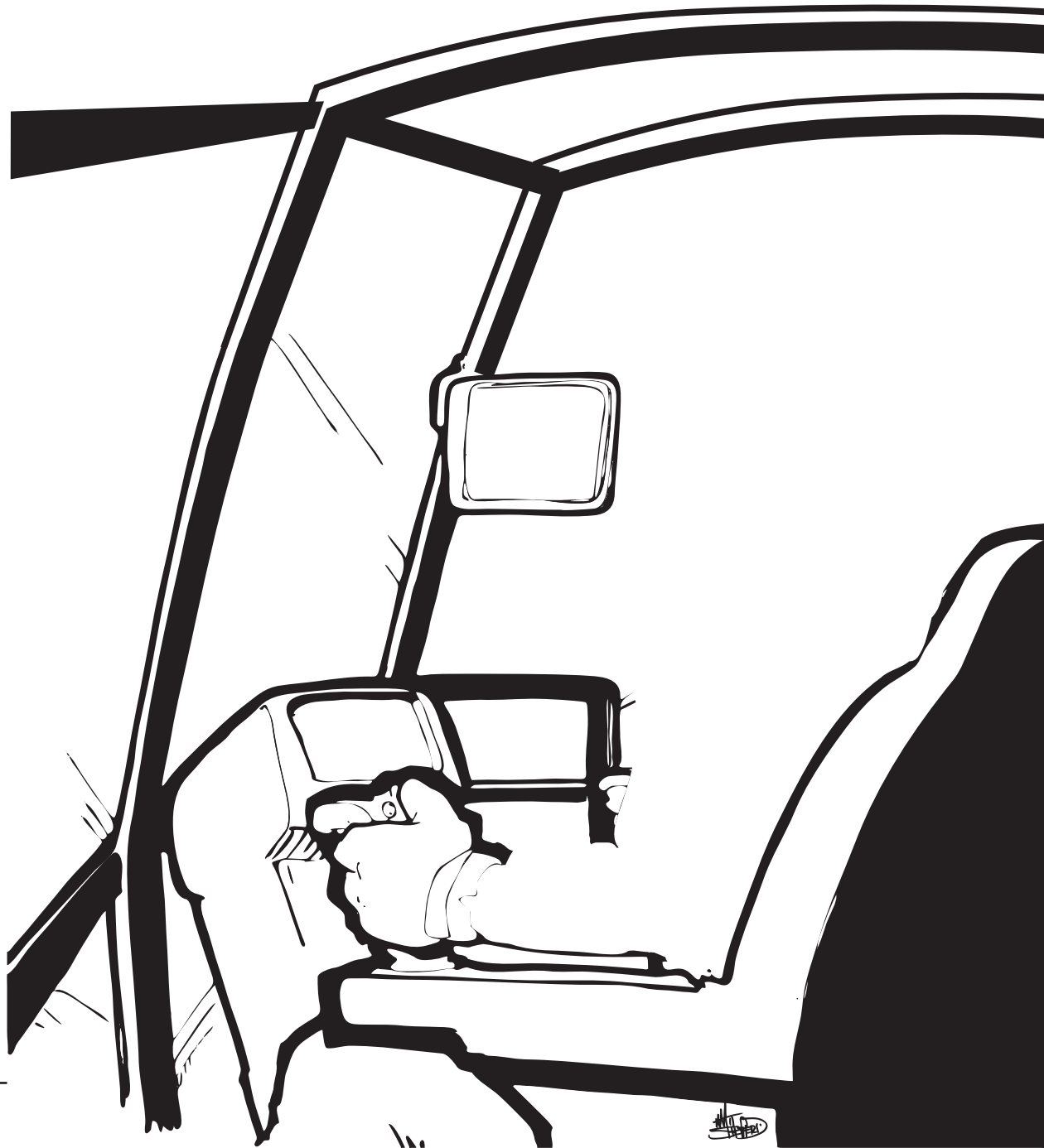

NAME \_\_\_\_\_



Draw **yourself** into the scene.

Some people build roads.  
Someday I want to  
(fill in the blank) \_\_\_\_\_  
\_\_\_\_\_  
\_\_\_\_\_

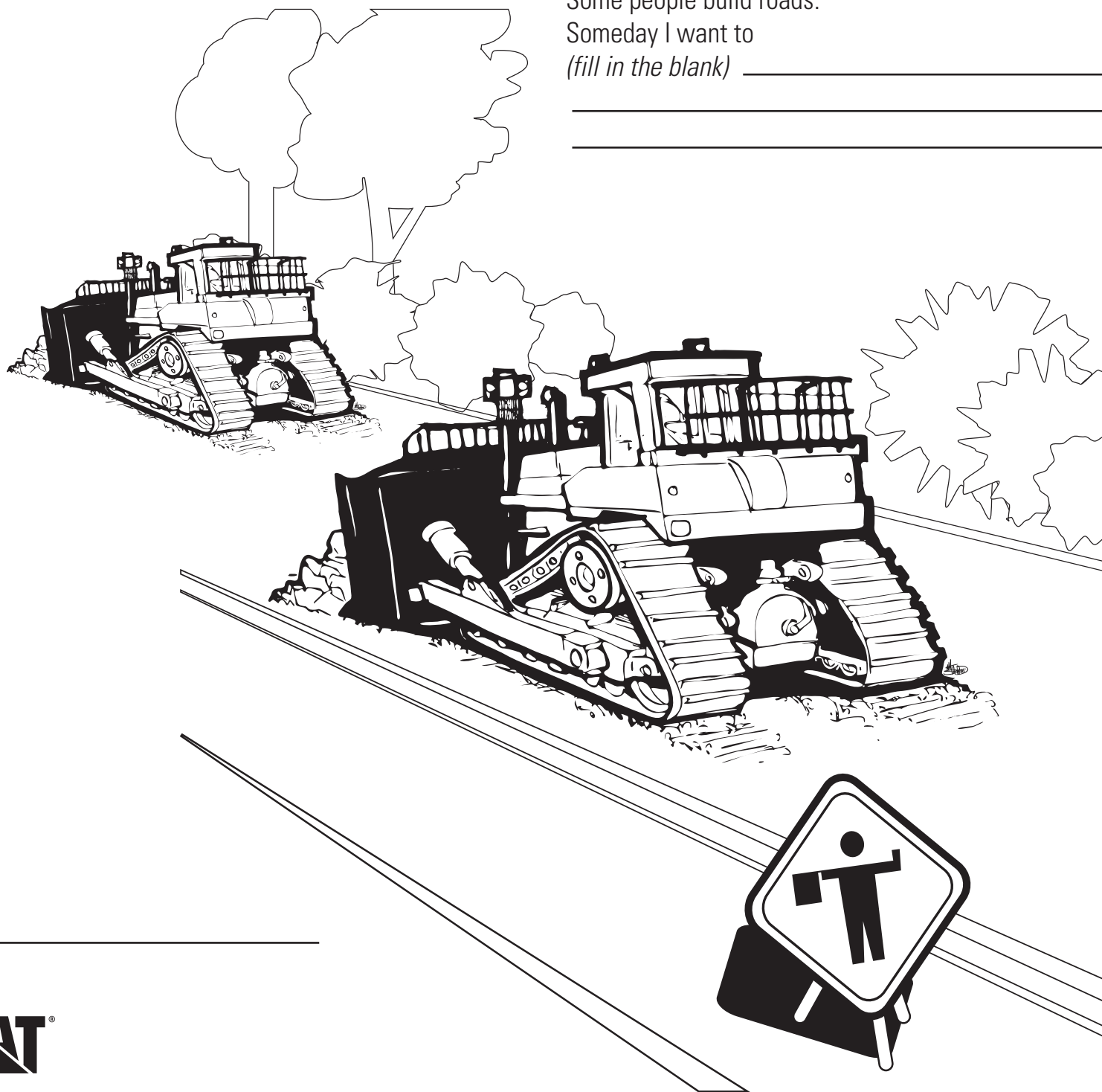

NAME \_\_\_\_\_



Draw **yourself** into the scene and complete what you think should be in the construction scene.

Some people build sidewalks and driveways.  
Some day I want to  
(fill in the blank) \_\_\_\_\_  
\_\_\_\_\_  
\_\_\_\_\_

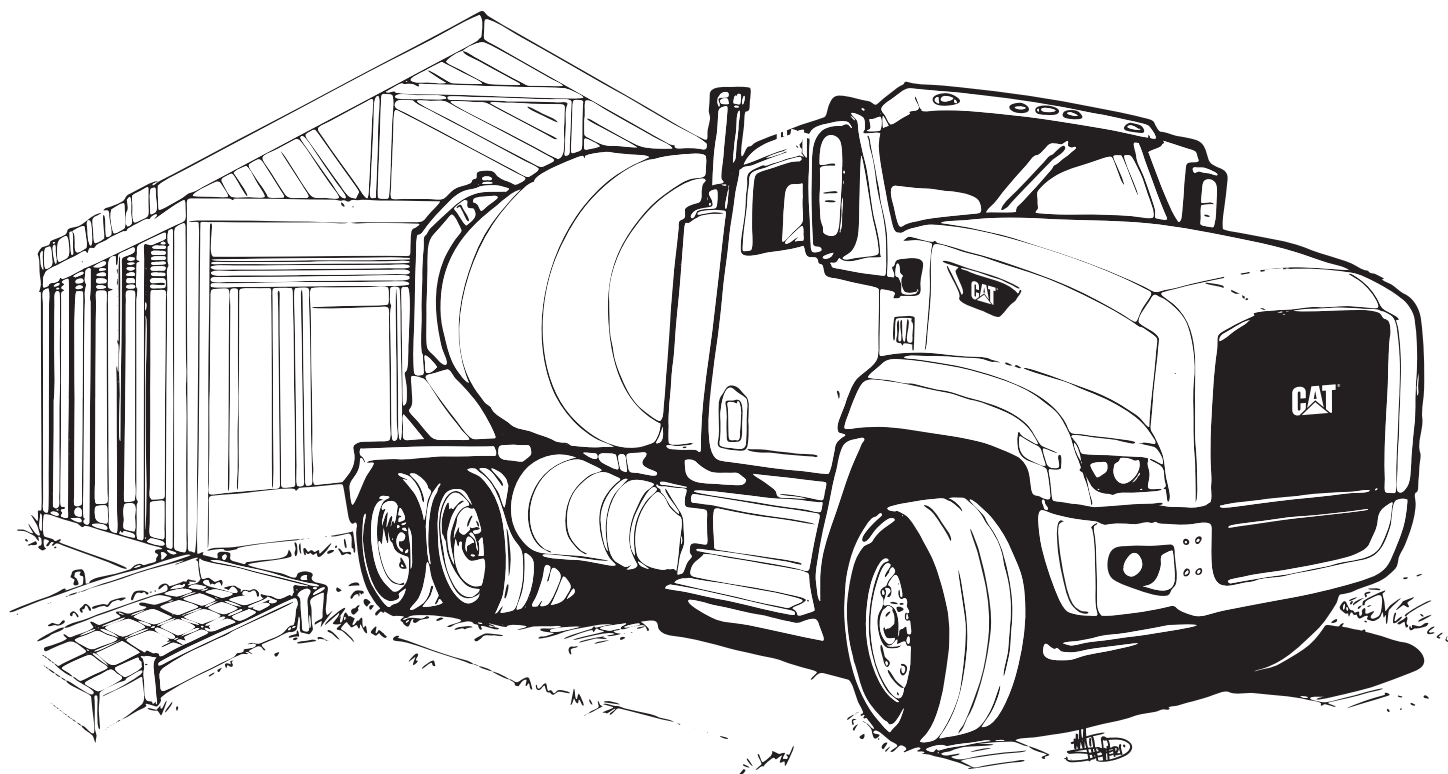

NAME \_\_\_\_\_



Can you draw your face?

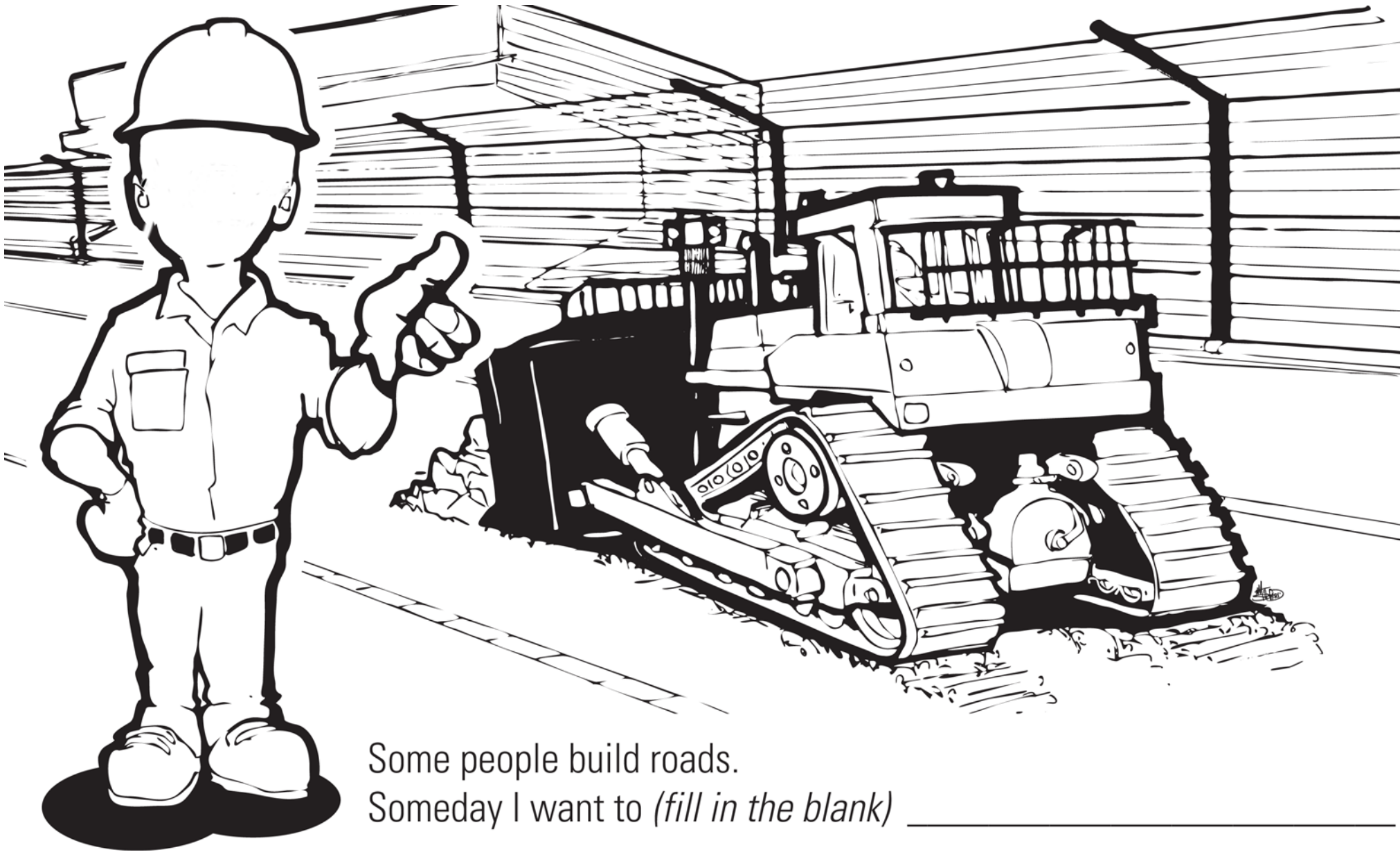

Some people build roads.  
Someday I want to *(fill in the blank)* \_\_\_\_\_

NAME: \_\_\_\_\_

AGE: \_\_\_\_\_

Draw what the operator sees in front of him and in his mirrors.



NAME: \_\_\_\_\_

AGE: \_\_\_\_\_