

MH3022

Wheel Material Handler

2017



Engine

| | | |
|---|------------------|-------------|
| Engine Model | Cat® C7.1 ACERT™ | |
| Emissions | EU Stage IV | |
| Power (Maximum) | | |
| ISO 9249 at 1,550 rpm | 126 kW | 169 hp |
| ISO 9249 at 1,550 rpm (metric) | | 171 hp (PS) |
| ISO 14396 at 1,550 rpm (gross) | 129.4 kW | 174 hp |
| ISO 14396 at 1,550 rpm (gross) (metric) | | 176 hp (PS) |

Weights

| | |
|--|---------------------|
| Operating Weight with Work Tool | 20 705 kg-25 450 kg |
| Working Ranges (MH boom, stick 4900 mm) | |
| Maximum Reach (stick pin) | 11 005 mm |
| Maximum Height (stick pin) | 12 065 mm |
| Drive | |
| Maximum Travel Speed | 25 km/h |

Introduction

We know that when it comes to material handling equipment, your success depends on high productivity and dependable performance.

The MH3022 anchors the smaller end of the new Cat wheel material handlers. It offers a great compromise between the agility, versatility and performance of a wheeled excavator and the stability, efficiency and power needed to cope with harsh environments and applications of industrial, scrap, waste recycling and bulk handling operations, which call for safe, quality and reliable products, while generating a low operating cost to the owner.

Contents

| | |
|--|----|
| Next Generation Key Features | 4 |
| Sustainability | 6 |
| Engine | 7 |
| Built-in Fuel Savers That Add Up | 7 |
| Hydraulic System | 8 |
| Structure – Elevated Cab and Frame | 10 |
| SmartBoom™ | 12 |
| Front Linkage | 12 |
| Smart Features | 13 |
| Load and Go Auto Axle Lock | 13 |
| Premium Comfort | 14 |
| Simplicity and Functionality | 15 |
| Serviceability | 16 |
| Integrated Technologies | 17 |
| Work Tool Attachments | 18 |
| Safety | 20 |
| Unmatched Visibility | 22 |
| Complete Customer Care | 22 |
| Specifications | 23 |
| Standard Equipment | 33 |
| Optional Equipment | 35 |





The new MH3022 is here to help you take on the wide variety of challenges you face every day, more easily and at a lower cost.

Commitment from the Ground Up.



Next Generation Key Features

Commitment from the Ground Up



Safety and Comfort Are Not Optional

- Embedded smart devices help enforce safe behaviors, like the automatic swing lock, brake and axle lock, and safety lever
- The cab contributes to your comfort with limited vibrations and drastically reduced sound levels
- Improved access with new and longer handrails, steps and service platform
- Improved visibility with enlarged glass areas, rear and side cameras and LED working lights



Make the Move to the Next Generation

Refinements. From the whole design to the smallest detail. Convenient features, new advanced and transparent technologies, not only to reduce emissions but to further improve your daily experience when working with our products.

Made to be Efficient

Recognizing that fuel efficiency is directly affected by hydraulic performance, the hydraulic system in the MH3022 is carefully designed to provide the work needed without wasting fuel. A high capacity hydraulic cooling system keeps operating temperatures well-balanced, resulting in longer component life, higher efficiency and lower repair cost.

Made to Keep Your Costs Down

Not only does the machine give you all the performance you need, but it does so while providing a great deal of precision, and speed with an absolute minimum fuel consumption – and zero impact on your efficiency.

Maintenance: Keep it Simple

Ground level and grouped service points, automatic central greasing, dedicated system compartments and many other features that make your maintenance quick and easy.

Made to Make Operation Easy and Pleasant

Have a seat, you will be impressed by the quietness and comfort of the cab. Feel relaxed, we help you make sure you're safe.

Integrated Technologies

Enjoy integrated technologies; they act transparently.

Be Flexible to Win

When you add the multiple Cat attachments that help you do all kinds of jobs, you simply won't find a better machine.





Sustainability

Generations Ahead in Every Way

Fuel Efficiency and Reduced Exhaust Emissions

The engine meets Stage IV emission standards, is powerful and efficient, with an optimized 10% fuel consumption improvement versus the previous model and no impact on your productivity. This means less resource consumption and fewer CO₂ emissions.

Quiet Operation

Outstandingly low sound levels, you won't believe your machine is running.

Transparent Technologies and Longer Service Intervals

- The Eco Mode, Auto Engine Speed Control and Engine Idle Shutdown help further reduce your overall fuel consumption.
- Product Link™ allows remote monitoring of the machine and helps improve overall efficiency.
- Your Cat dealer can help extend service intervals, meaning fewer fluids and disposals, all adding up to lower costs.

Biodiesel and Biodegradable Hydraulic Oil

- The MH3022 has the flexibility of running on either ultra-low-sulfur diesel (ULSD) fuel with 10 ppm of sulfur or less or up to B20 biodiesel fuel blended with ULSD.
- Cat BIO HYDO™ Advanced HEES™ reduces the impact on the environment.

Cat Certified Used

This program is a key element in the range of solutions offered by Caterpillar and Cat dealers to help customers achieve growth at the lowest cost while eliminating waste. Used equipment is inspected, guaranteed and ready for work and customers will benefit from a Caterpillar warranty.

Engine

Power, Reliability, and Fuel Economy



The Power and Performance You Need

Constant Power Strategy

Provides a quick response to changing loads, while delivering the same amount of power regardless of operating conditions.

A Transparent Emission Solution That Works.

The Cat C7.1 ACERT engine meets today's Stage IV emission standards, and it does so without interrupting your job process. It is designed to be:

- **Transparent:** no operator intervention
- **Durable:** fit for life Diesel Particulate Filter
- **Efficient:** no work interruption, even in case of extended idling time
- **Simple:** minimum maintenance. Longitudinal engine installation, which further simplifies maintenance

Biodiesel Not a Problem

The engine can run on up to B20 biodiesel fuel that meets ASTM 6751 standards – all to give you more potential fuel-saving flexibility.

Proven Technology

To assure that our technology will meet your expectations for reliable trouble-free service, we subjected these engines and technologies to extensive operating hours of test and validation.

Built-in Fuel Savers That Add Up

- **Automatic Engine Speed Control:** lowers engine speed when it is not needed.
- **Engine Idle Shutdown:** turns the engine off when it's been idling for more than a pre-set amount of time.
- **On-Demand Cooling System:** variable speed and on-demand fan.
- **Enhanced Eco Mode:** reduces engine speed while delivering the same power.
- **Automatic Shift to Travel Mode** when you start driving.
- **NEW! Optimized Travel Mode:** travel mode rpm levels are set automatically on-demand only to further reduce fuel consumption.

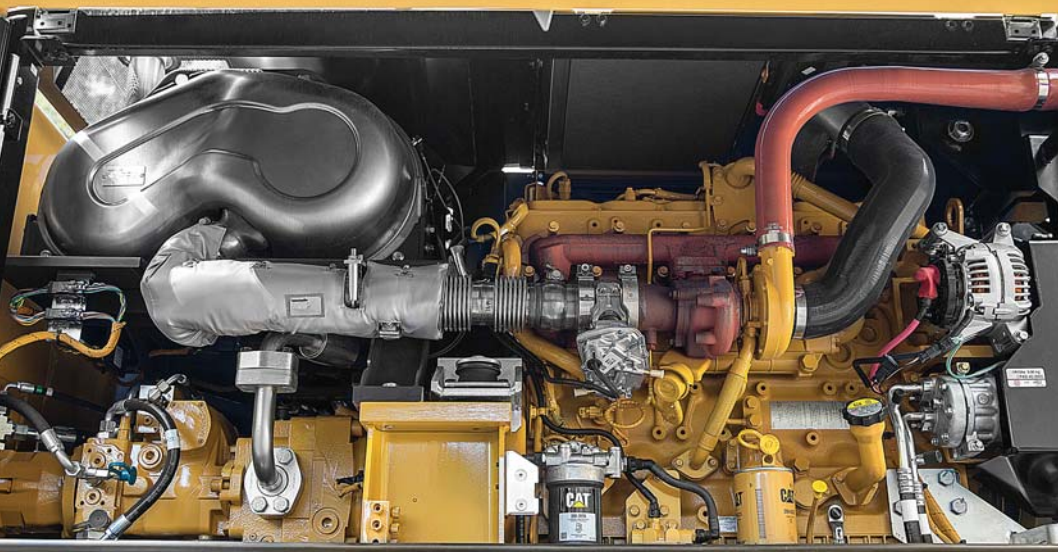

Hydraulic System

Fast, Precise, Flexible



When it comes to moving material quickly, you need efficient hydraulics – the type the MH Series can deliver.

Efficient Design, Smart and Fast

- **Simple Design** – The new hydraulic valve compartment and routings offer a simple and clean design to help ensure durability.
- **Smart Main Hydraulics** – The system allows reducing the load on the engine when not needed, which translates into lower fuel consumption.
- **Dedicated Swing Pump** – A closed hydraulic circuit is dedicated to the swing only. Having two separate pumps, one for the swing and the second for the other functions allows faster and smoother combined movements.

Control Like No Other

- **Electronic Pump Control** – Controllability is one of the main attributes of the MH3022, and one of the key contributors to this is the Electronic Pump Control (EPC) that's designed to improve response time and precision. It puts flow exactly where you need it, when you need it, which means a much smoother operation and greater efficiency.
- **Adjustable Hydraulic Sensitivity** – Allows you to adjust the aggressiveness of the machine according to the application.
- **Stick Regeneration Circuit** – Increases efficiency and helps enhance controllability for higher productivity of straight sticks with linkage.



Well Balanced Cooling Package

The hydraulic oil cooler is mounted side-by-side with the engine radiator and the air-to-air aftercooler (ATAAC). Located separately from the engine and featuring a well-balanced sizing, the new cooling package offers unprecedented up-times even in difficult environments.

Structure – Elevated Cab and Frame

Strength, Flexibility and Mobility



High Visibility – 2400 mm Elevated Cab

The hydraulic cab riser is designed to be:

- Stable – Wide lift arms, deep box-sectioned design, strong top and bottom links and retractable hydraulic cylinders used to raise the cab for greater stability.
- Fast – Two heavy-duty hydraulic cylinders provide quick and controlled up and down travel.
- Comfortable – The parallelogram design of the linkage allows the cab to remain level at all ranges of motion. Cab movement is also slowed as it reaches the end of the riser stroke, with no sudden start/stop effect.
- Safe – The cab can be lowered using either a lever inside the cab or one on the frame at ground level in the event of a hydraulic malfunction.

Undercarriage Options

Effective hydraulic line routing, transmission protection and heavy-duty axles make the Cat undercarriages perfect for material handler applications. Four different undercarriages are available to provide the stability you need for your applications:

- Material Handling – The Material Handling undercarriage with four welded outriggers is ideal when extra stability is needed.
- Material Handling with Dozer Blade – An optional expansion to the Material Handling Undercarriage includes an additional dozer blade mounted ahead of the front stabilizers to be used to push material commonly encountered in waste and millyard applications.
- The Material Handling Narrow undercarriage, specifically designed for limited space applications – Thanks to smaller undercarriage width and length, compared to MH undercarriage, and thanks to its symmetrical design, this MH Narrow undercarriage enhances maneuverability and flexibility in tight areas.
- The standard undercarriage allows for different kinds of stabilizers and blades to be attached either to the front or to the rear.

Heavy-Duty Axles

The front axle offers wide oscillating and steering angles. The transmission is mounted directly on the rear axle for protection and optimum ground clearance. The drive shaft offers long service intervals.

Advanced Disc Brake System

The disc brake system acts directly on the hub instead of the drive shaft to avoid planetary gear backlash. This minimizes the rocking effect associated with working free on wheels.

Driveline Concept

The driveline design effectively utilizes engine torque and power to provide a comfortable ride with improved smoothness.

Travel mode rpm levels are set automatically and “on-demand only” to further reduce fuel consumption.





Front Linkage

No Compromise on Durability

You know that a material handler works only as good as its front linkage is able to handle the job. The MH3022's booms and sticks are purpose built for the loads encountered in material handling applications.

MH Boom

MH booms include high pressure hydraulic lines for opening and closing functionality and medium pressure lines for implement rotation. A short MH boom is available to match indoor applications while retaining the same performance and lifting capabilities.

MH Sticks

MH sticks are equipped with high and medium pressure auxiliary lines. The 4900 mm Drop Nose Stick offers the reaching and lifting capabilities required for typical MH applications, while the 4200 mm Straight Stick is the best solution when additional work tool functionality is needed.

Special Applications

The MH3022 offers the ability to combine the hydraulic cab riser with a traditional excavator front linkage. This combination has been proven in transfer station, mining, and millyard applications.

Standard stick as well as industrial sticks are available in combination with a variable adjustable (VA) or one-piece boom.

SmartBoom

Allow Your Operator to Fully Concentrate on Production

The unique Cat SmartBoom significantly enhances operator comfort and job efficiency by reducing stress and vibrations transmitted to the machine. Loading is more productive and more fuel efficient as the return cycle is reduced while the boom down function does not require pump flow.

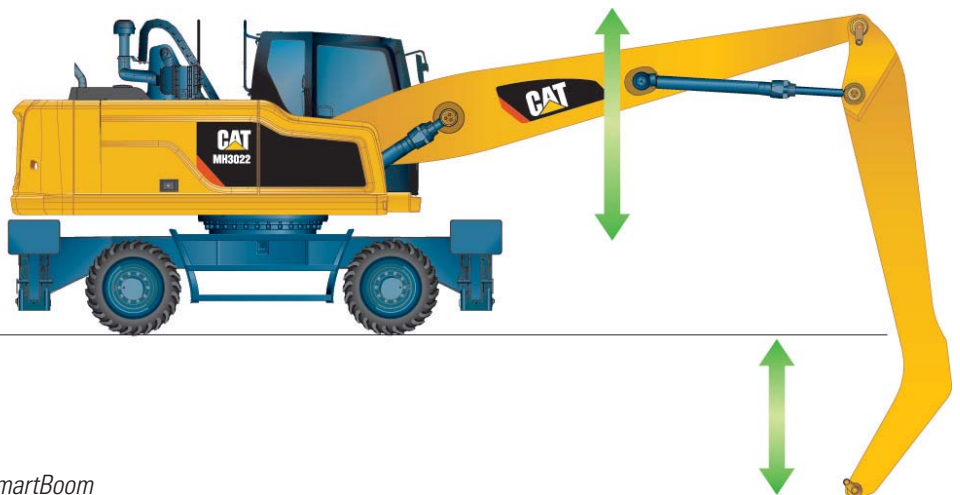

SmartBoom

Smart Features

Easier than Ever

Joystick Steering (Optional)

Keep both hands on your joysticks even when you need to reposition the machine while simultaneously moving the implements.

Swing and Auto Travel Lock

No need for the operator to bend to engage the swing lock pin.

- Just press a button,
- Align the upper to the lower frame,
- Enjoy the ride: a green indicator confirms the swing and the implements have been automatically locked.
- NEW! The swing lock can be applied independently from the implements lock at low speed (below 5 km/h)

Integrated Pin Code

No need to buy an optional security system to protect your equipment against theft.

- The pin code is integrated into the monitor (standard)
- Entering the right code allows the engine to start

The Machine Security System (MSS – optional) adds even more protection when needed.

Cruise Control

No need to press the pedal all the time.

- Choose the very speed you wish
- Press the quick access button on the monitor
- Enjoy the ride



Load and Go Auto Axle Lock Presses the Pedal for You, Reducing the Number of Actions You Need to Do

The machine automatically detects when the service brake and axle need to be locked (like when working), or unlocked (roading), hence removing the need for the operator to systematically press the pedal. Brake and axle are released automatically by pressing the travel pedal again.



Premium Comfort

Keeps Operators Productive All Shift Long



Designed for the operator, our cabs are unique.

Ergonomic Layout

- Frequently used switches are centralized, kept to the minimum and ideally located close to the joysticks.
- Storage compartments are useful ... when well designed. Several areas provide sufficient room to store a hard hat, a drink, phone, or keys.

Comfortable Seat Options

Our seats provide all the comfort needed for a long day of work, including FULL adjustment. All seats are heated and air suspended. Automatic weight adjustment and ventilated seats are available.

Safety Is Not Optional

FOPS cabs, seat belt alarm, safety lever, sideview camera ... among others.

Details That Make the Difference

Have a look at the cab; you will see it is through details that we improve pleasure of operating.

Smart Controls to Reduce Fatigue

- Features like SmartBoom or joystick steering will be precious to increase your productivity.
- New technologies that work transparently like the swing and auto travel lock or the automatic brake and axle lock, reduce the number of tasks you need to do.

Plug, Charge and Play Your Devices

- The 12V 10A power supply socket is conveniently located for charging your laptop, or a tablet.
- A CD/MP3 radio with speakers and USB port is available.





Simplicity and Functionality

For Ease of Operation

A Cab Just for You – Fully Adjustable

- Seat armrests, in height and angle
- Steering column adjustment, not only tilting fore/aft but also in height
- Hydraulic sensitivity of the machine to make it more or less aggressive
- NEW! Joystick and left pedal controls assignments: can be set up as desired and per tool
- NEW! Optional advanced joystick offering more controls (two sliders, five buttons each)
- Automatic air conditioning
- NEW! Optional heated mirrors are now also electrically adjustable from the cab



Incredibly Low Sound Levels, Less Fatigue

Increased cab pressure, preventing from dust entry, combined with the cab design contributes to reducing sound.

Outstanding Visibility: See the difference!

- All glass areas have been drastically increased
- Standard LED working lights and halogen front roading lights
- Standard LED dome light
- Standard rearview AND sideview wide angle cameras
- Wide angle mirrors for a better visibility even down to the ground
- Parallel intermittent (four speeds) wipers covering the whole windshield

NEW! Standard LED Lights for BOTH Cameras to See What's Going on Around, Day or Night.

The rear camera is integrated into the counterweight for enhanced protection.

NEW! Split-Screen View of BOTH Cameras on the Same Monitor

The views from both cameras are displayed side by side on the additional wide color monitor for better visibility at first glance.

Large Color Machine Monitor

Easy to read and in local language, the high resolution LCD monitor will keep you aware of any important information.

“Quick Access” buttons allow a quick selection of favorite functions. The tool select function lets you preset up to ten different hydraulic attachments for quick tool changes.

Serviceability

When Uptime Counts

Convenient Access Built In

You can reach routine maintenance items like fuel and engine oil filters and fluid taps at ground level while fuel and DEF tank accessible from the safety of the slip-resistant new service foldable step. Compartments feature wide composite service doors, designed to be more resistant to shocks, which all include gas struts to facilitate the opening.

A Smart Design for Any Temperature

The side-by-side coolers and axial fan design allows greater cooling performance. The system is completely separated from the engine compartment to reduce noise and heat, and all radiators are gathered in the same compartment while featuring easy-to-clean cores with a tilting device that requires no tool to unlock.

- The optional Cooling Protection Package includes a fine mesh for enhanced radiator protection and an engine air pre-cleaner.
- The optional Waste Handling Package adds a reversing fan rotation function with adjustable intervals and a vibrating grill on the cooling hood. This vibration together with the reversed airflow direction will shake accumulated particles off the mesh.

A Fresh Idea

Ventilation inside the cab allows outside air to enter through a fresh air filter. The filter is located on the side of the cab to make it easy to reach, and it is protected by a lockable door that can be opened with the ignition key.

Lube and Fuel Options

An automatic lubrication system is a time-saving standard feature for greasing the whole uppercarriage. Greasing points for the undercarriage are kept to a minimum and grouped. An electric refueling pump is also available. The hose is stored in a dedicated tray, for more cleanliness. Add in the new electric lift pump removing the need to prime the system manually, the standard fuel and water separator and you get a machine that does the fastidious maintenance works for you.

Keep it simple.



Integrated Technologies

It Pays to Know



Cat Connect makes smart use of technology and services to improve your job site efficiency. Using the data from technology-equipped machines, you'll get more information and insight into your equipment and operations than ever before.

Cat Connect technologies offer improvements in these key areas:



Equipment Management – increase uptime and reduce operating costs.



Productivity – monitor production and manage job site efficiency.



Safety – enhance job site awareness to keep your people and equipment safe.

Featured Cat Connect technologies include the following:

Link

Link technologies provide wireless capability to machines to enable two-way transfer of information collected by on-board sensors, control modules, and other Cat Connect technologies.

Manage Your Machine Remotely

Cat Product Link is a system that is deeply integrated into the machine monitoring system to take the guesswork out of managing your equipment. The system tracks location, hours, fuel usage, productivity, idle time, and diagnostic codes and shares it with you through VisionLink® to help you maximize efficiency, improve productivity, and lower operating costs.

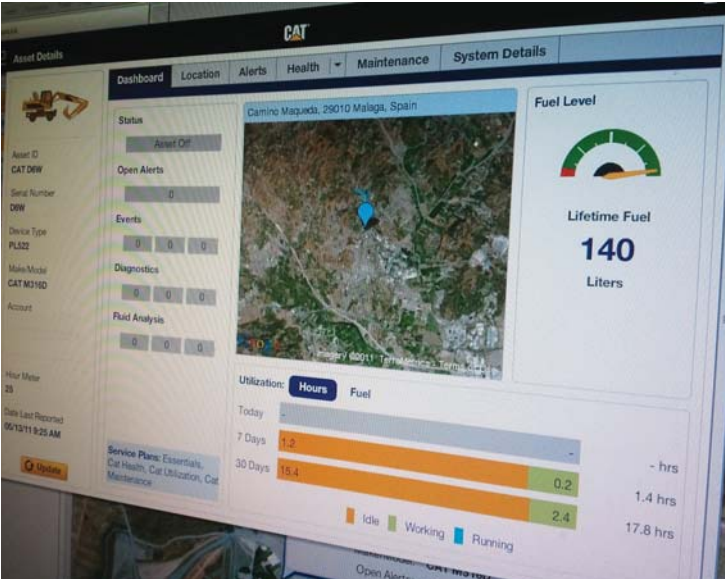

CAT® CONNECT



Work Tool Attachments

Move More, Make More



New! Optional 15 kW Cat Generator with Solid State Controller

If your work tool or application needs additional power for operation, the MH3022 can come equipped with an optional 15 kW solid state generator. Experience enhanced sorting ability through the proprietary solid state generator control. The genset is capable of producing enough power to operate up to a 1.4 m (57") diameter magnet. The optional solid state genset would be placed in the upper frame for ease of maintenance without obstructing other machine components.

With the operator friendly material sorting control enables the machine operator to turn the magnet current on and off at quick intervals without initiating the actual "drop" or "reverse current" cycle of the magnet which completely and quickly cleans the material off of the magnet during normal production handling.

This proprietary generator system is designed, sold and serviced by Caterpillar and Cat dealers worldwide.





Attachment Solutions for Industrial and Recycling Applications

When productivity, reliability and stability are important, Cat attachments are the perfect solution for the MH3022.

Productive and Perfectly Matched

Loading and unloading is foundational to your productivity. Grapples are sized right for the MH3022. They are designed for maximum penetration into the pile. The full power of your machine is utilized to provide fast open/close times and powerful closing force. Full, 360° rotation systems allow precise placement. Together, a MH3022 and Cat grapple allow you to move volumes with minimal time and effort.

Built for Severe Material

Cat grapples are built to take on the material you move. Hydraulic components are protected from damage, yet easily accessed for routine maintenance. Areas that dig and penetrate are made of high quality, wear resistant material. Cat grapples last for a positive impact to your bottom line.

Orange Peel Grapples

The perfect solution for scrap yards, recycling plants and transfer stations. These grapples are available with 4 or 5 tines, in capacities from 600 to 1000 L. Several shell choices allow further customization of your grapple to the specific material you work with.

Clamshell Grapples

The perfect solution for loading and transferring large volumes of loose material like grain, coal, sand and gravel. These grapples are configured with several shells for different capacity options to meet your specific requirements.

Digging Grapples

Cat Digging grapples are designed to suit MH machines for digging applications where good penetration is required.

Waste Handling Grapples

The dedicated waste handling grapple has been specifically designed to offer high volume for maximum loads and proven fuel consumption.



Get the Most from Your Machine

You can easily expand all the possibilities the MH3022 offers by utilizing a straight stick linkage and combining it with any of the variety of Cat attachments for excavators. In this case, a quick coupler will bring the ability to quickly change attachments.

Safety

Your Safety Is NOT Optional

Embedded Features

Smart embedded devices help enforce safe behavior:

- Safety seat belt and warning indicators (monitor)
- Automatic swing lock
- Automatic brake and axle lock
- Safety lever, preventing exit when the implements are not locked out
- Emergency shut off switch and battery disconnect switch
- Travel alarm
- Lowering check valves
- NEW! Quick coupler control switch, ISO 13031 compliant

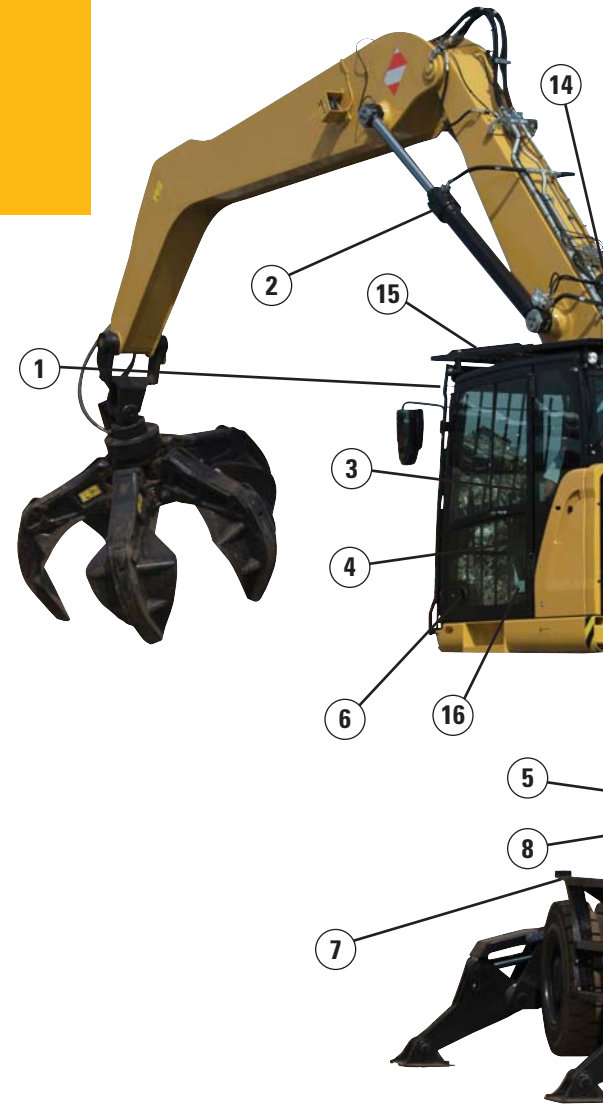

Cab Ingress

We bring a solution to allow you to safely climb into the cab:

- Three longer access steps, aligned with the cab entry
- Additional step integrated into the skirt, directly below the cab door
- Anti-skid plates on all walkways and steps reducing slipping hazards
- Tiltable console to make sure the way in and out is free of obstacles
- New! Optional Easy Cab Access Package featuring a rigid ladder mounted on the rear axle (right side) for straight access into the cab from the ground.

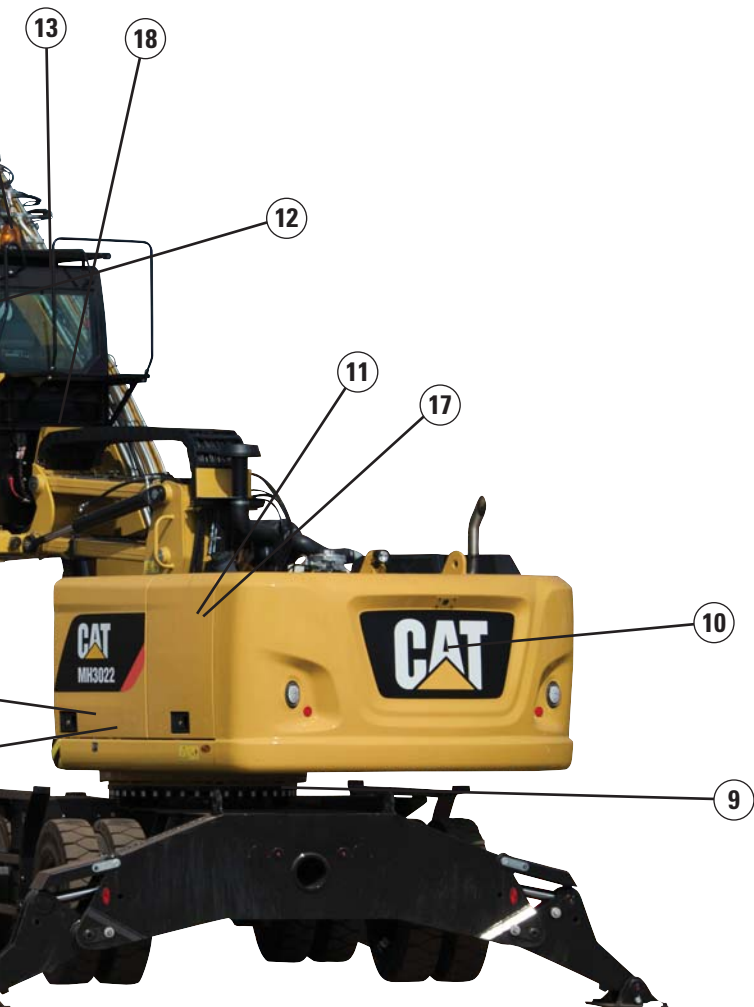

- 1) Laminated windshield and skylight window
- 2) Lowering check valves
- 3) Safety seat belt indicator
- 4) Safety lever
- 5) Emergency shut-off switch
- 6) Automatic brake and axle lock
- 7) Punched, anti-slippery walking surfaces
- 8) Battery disconnect switch
- 9) Swing and implement electronic lock
- 10) Adjustable travel alarm
- 11) All doors equipped with gas strut cylinders
- 12) Emergency hammer and exit
- 13) Sound proofing
- 14) Beacon available
- 15) FOPS cab and top/front guards compatibility
- 16) Safety lever to lower the cab, either from the ground or directly from the cab
- 17) Foldable service platform
- 18) Cab Advanced Pre-Filtration System (optional)

Safe and Quiet Cab

The cab provides you with a safe environment. It also contributes to your comfort with limited vibrations and low sound levels.

Great Views

- Enlarged glass gives you excellent visibility to the front, top, rear, and sides, even to the right
- Standard rearview camera gives you a clear field of view behind the machine
- NEW! Monitor split-screen to easily check cameras rearview and sideview on the same display
- Standard sideview camera, to check nothing is hidden to you from the front right hand side to the rear of the machine
- Lenses of all the cameras are wide angle and heated
- All mirrors are wide angle and allow view not only around the machine but also to the ground

New! Safety Options for Specific Applications

- **Impact Resistant One-Piece Windshield and skylight**, 10 mm thick, fulfills EN356 P5A standards.
- **High Impact Resistant fixed Windshield (two-parts) and skylight**, 26 mm thick, fulfills EN356 P8B standards.
- **Advanced Cab Pre-Filtration Package** – A cab pre-filtration package reduces dust entry and air contamination. It includes:
 - an integrated air pre-cleaner, which also extends filters life
 - a fresh air filtration system with H13 and ABEK1 Hg filters against odor and gas
 - a recirculation filtration system, with a H13 filter

Unmatched Visibility

Make Sure Nothing Is Hidden to You

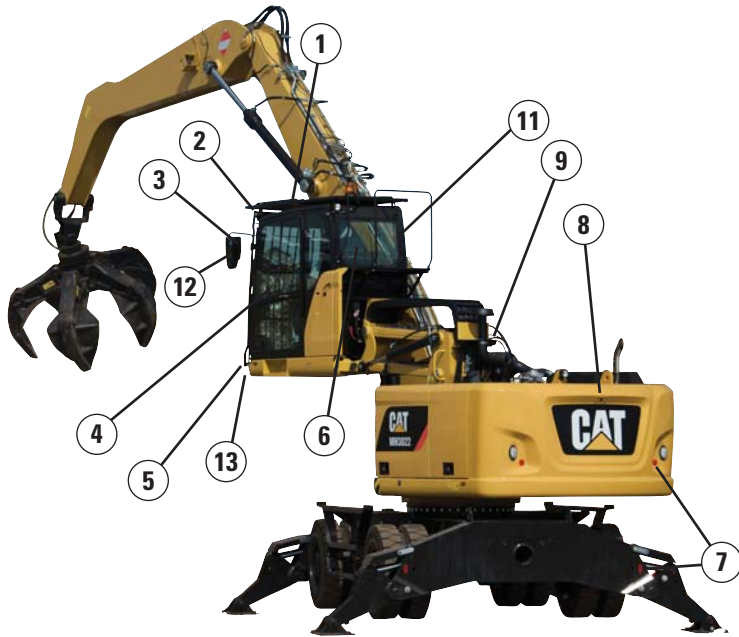

Visibility all around is critical, especially for machines working and driving on industrial job sites.

- 1) Increased skylight and windshield glass areas
- 2) Standard LED lights for all working lights
- 3) Optional electrically adjustable and heated mirrors
- 4) Great left hand side visibility with all glass door
- 5) Halogen front roading lights
- 6) Wide rear window
- 7) Red reflectors, on counterweight and rear blade/outriggers
- 8) Standard wide angle rearview camera with LED light
- 9) Standard wide angle sideview camera with LED light
- 10) Split-screen display of both cameras on the same monitor
- 11) Large right hand side window
- 12) Mirrors, wide angle, with additional lower mirror for ground visibility
- 13) High visibility – 2400 mm elevated cab

Complete Customer Care

Your Cat Dealer Will Support You Like No Other

Support You Can Count On

From helping you to choose the right machine to knowledgeable on-going support, Cat dealers provide the best-in-sales and services.

- **Best long-term investment** with financing options and services
- **Productive operation** with training programs
- **Preventive maintenance** and guaranteed maintenance contracts
- **Uptime**, with best-in-class parts availability
- **Repair, rebuild, or replace?** Your dealer can help evaluate the best option.

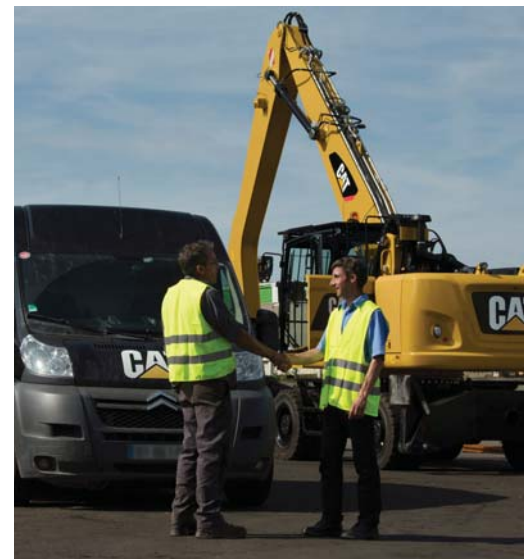

MH3022 Wheel Material Handler Specifications

Engine

| | | |
|----------------------------------|-------------------------------|--------|
| Engine Model | Cat C7.1 ACERT ⁽¹⁾ | |
| Ratings | 1,550 rpm | |
| Engine Gross Power (Maximum) | | |
| ISO 14396 | 129.4 kW | 174 hp |
| ISO 14396 (metric) | 176 hp (PS) | |
| Net Power (Rated) ⁽²⁾ | | |
| ISO 9249/SAE J1349 | 126 kW | 169 hp |
| ISO 9249/SAE J1349 (metric) | 171 hp (PS) | |
| 80/1269/EEC | 126 kW | 169 hp |
| Net Power (Maximum) | | |
| ISO 9249/SAE J1349 | 126 kW | 169 hp |
| ISO 9249/SAE J1349 (metric) | 171 hp (PS) | |
| 80/1269/EEC | 126 kW | |
| Bore | 105 mm | |
| Stroke | 135 mm | |
| Displacement | 7.01 L | |
| Maximum Torque at 1,400 rpm | 830 N·m | |
| Number of Cylinders | 6 | |

⁽¹⁾ Meets Stage IV emission standards.

⁽²⁾ Rated speed 1,550 rpm. Constant power from 1,500-1,550 rpm.

- Net power advertised is the power available at the flywheel when engine is equipped with air cleaner, CEM exhaust gas aftertreatment, alternator, and cooling fan running at intermediate speed.
- No deratings required up to 3000 m altitude. Automatic derating occurs after 3000 m.

Transmission

| | |
|-----------------------------------|-----------|
| Forward/Reverse | |
| 1st Gear | 10.0 km/h |
| 2nd Gear | 25.0 km/h |
| Creeper Speed | |
| 1st Gear | 3.0 km/h |
| 2nd Gear | 10.0 km/h |
| Drawbar Pull | 127 kN |
| Maximum Gradeability at 23,500 kg | 65% |

Swing Mechanism

| | |
|----------------------|---------|
| Maximum Swing Speed | 8.1 rpm |
| Maximum Swing Torque | 54 kN·m |

Undercarriage

| | |
|--|---------|
| Axle Ground Clearance* | 325 mm |
| Maximum Steering Angle | 35.0° |
| Oscillation Axle Angle | ±5.0° |
| Minimum Turning Radius** | |
| Outside of Tire | 6800 mm |
| End of VA Boom | 7600 mm |
| End of One-Piece Boom | 9000 mm |
| End of MH Boom (with 4.9 m drop-nose stick) | 8800 mm |

*Dimension for standard and MH undercarriage. For machines fitted with 11.00-20 pneumatic tires, add 35 mm.

**Boom and stick in travel position.

Service Refill Capacities

| | |
|------------------------------------|--------|
| Fuel Tank (total capacity) | 330 L |
| Diesel Exhaust Fluid Tank | 34.5 L |
| Cooling System | 46.9 L |
| Engine Crankcase | 18.5 L |
| Rear Axle Housing (differential) | 14 L |
| Front Steering Axle (differential) | 10.5 L |
| Final Drive | 2.5 L |
| Powershift Transmission | 2.5 L |

MH3022 Wheel Material Handler Specifications

Weights

| | |
|--|------------------|
| Operating Weights* | 21 655-23 670 kg |
| Long MH Boom (6.4 m) | |
| MH Undercarriage, Straight Stick | 23 670 kg |
| MH Undercarriage, Drop Nose Stick | 23 250 kg |
| MH Narrow Undercarriage, Drop Nose Stick | 22 340 kg |
| Standard Undercarriage**, Straight Stick | 22 730 kg |
| Short MH Boom (5.35 m) | |
| Narrow Undercarriage, Straight Stick | 22 540 kg |
| One-Piece Boom | |
| Standard Undercarriage**, Industrial Stick | 21 740 kg |
| VA Boom | |
| Standard Undercarriage**, 2800 mm Stick | 22 630 kg |
| Sticks*** | |
| Digging (2800 mm) | 925 kg |
| Straight (4200 mm) | 1315 kg |
| Drop Nose (4900 mm) | 885 kg |
| Industrial (3300 mm) | 515 kg |
| MH Push Blade | 675 kg |
| Dozer Blade | 850 kg |
| Solid Tires (delta vs. standard tires) | 950 kg |
| Counterweights | |
| Standard | 3700 kg |
| Optional | 4200 kg |

*Operating weight includes solid tires, 3700 kg counterweight, full fuel tank, operator, four outriggers undercarriage, attachment (1400 kg). Weight varies depending on configuration.

**Standard undercarriage with 2 sets of outriggers and dual pneumatic tires.

***Includes cylinder, bucket linkage, pins and standard hydraulic lines.

Hydraulic System

| | |
|---------------|-------|
| Tank Capacity | 153 L |
| System | 345 L |

Hydraulic System: Maximum Pressure

| | |
|-------------------|---------|
| Implement Circuit | |
| Normal | 350 bar |
| Heavy Lift | 370 bar |
| Travel Circuit | 350 bar |
| Auxiliary Circuit | |
| High Pressure | 350 bar |
| Medium Pressure | 210 bar |
| Swing Mechanism | 310 bar |

Hydraulic System: Maximum Flow

| | |
|--------------------------|-----------|
| Implement/Travel Circuit | 288 L/min |
| Auxiliary Circuit | |
| High Pressure | 250 L/min |
| Medium Pressure | 49 L/min |
| Swing Mechanism | 108 L/min |

Tires

10.00-20 (dual pneumatic)*

11.00-20 (dual pneumatic)**

10.00-20 (dual solid rubber)

*Not compatible with MH undercarriage.

**Not compatible with MH Narrow undercarriage.

Push Blade

| | |
|--------------|---------|
| Blade Type | Radial |
| Blade Height | 920 mm |
| Width | 2990 mm |

MH3022 Wheel Material Handler Specifications

Emissions and Safety

| | |
|----------------------------------|--|
| Engine Emissions | Stage IV |
| Diesel Exhaust Fluid | Must meet ISO 22241 |
| Fluids (Optional) | |
| Cat Bio HYDO Advanced | Readily biodegradable EU Flower eco-label certified |
| Biodiesel up to B20 | Meets EN 14214 or ASTM D6751 with EN590 or ASTM D975 standard mineral diesel fuels |
| Vibration Levels | |
| Maximum Hand/Arm | |
| ISO 5349:2001 | <2.5 m/s ² |
| Maximum Whole Body | |
| ISO/TR 25398:2006 | <0.5 m/s ² |
| Seat Transmissibility Factor | |
| ISO 7096:2000-spectral class EM5 | <0.7 |

Standards

| | |
|-------------------------------|--|
| Operator Protective Structure | |
| Top/Front Guards | FOPS (Falling Object Protective Structure) meets FOPS criteria ISO 10262:1998 and SAE J1356:2008 |
| Cab/Sound Levels | Meets appropriate standards as listed below |

Sound Performance

| | |
|-----------------|-----------|
| Operator Sound | |
| 2000/14/EC | 71 dB(A) |
| Spectator Sound | |
| 2000/14/EC | 99 dB(A)* |

- *Noise level is for a machine without the generator.
- Operator Sound – The operator sound level is measured according to the procedures specified in 2000/14/EC, for a cab offered by Caterpillar, when properly installed and maintained and tested with the door and windows closed.
 - Exterior Sound – The labeled spectator sound power level is measured according to the test procedures and conditions specified in 2000/14/EC.
 - Hearing protection may be needed when operating with an open operator station and cab (when not properly maintained for doors/windows open) for extended periods or in noisy environment(s).

MH3022 Wheel Material Handler Specifications

Dimensions – With Standard Undercarriage, Two Sets of Outriggers

All dimensions are approximate.

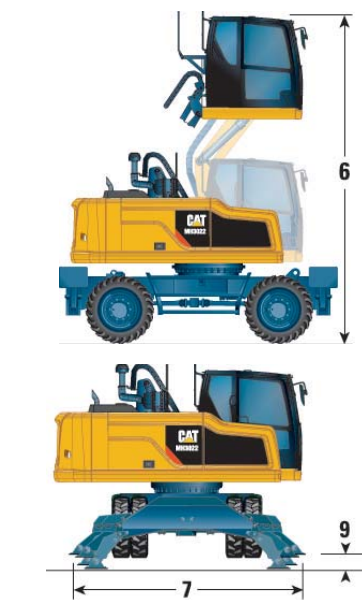
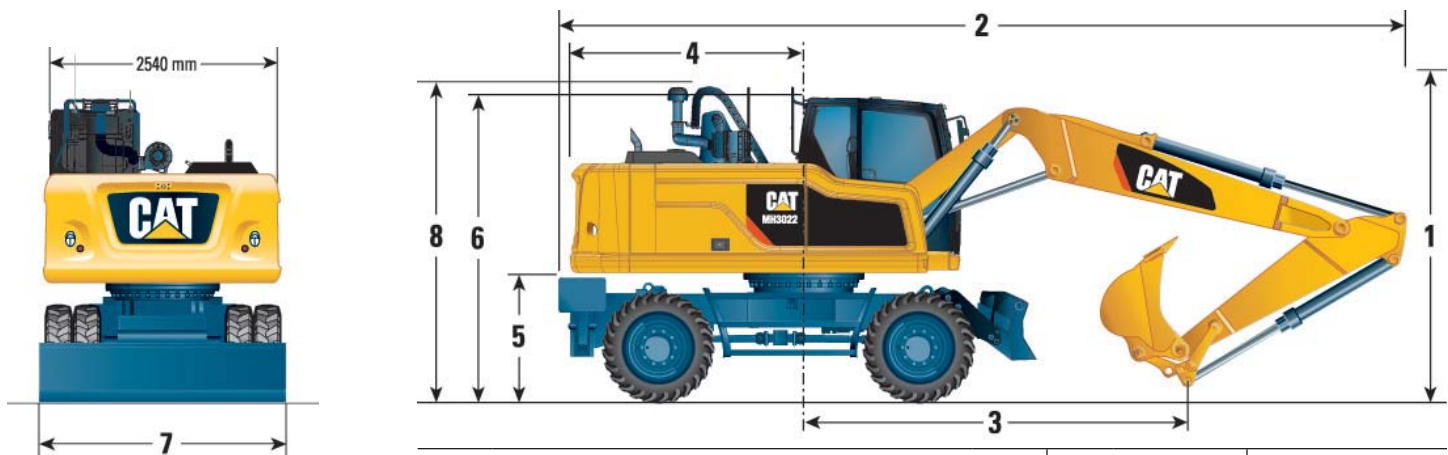

Undercarriage with 2 sets of outriggers

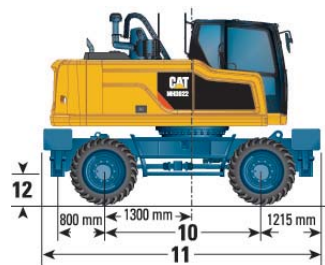

Undercarriage with 1 set of outriggers and dozer blade

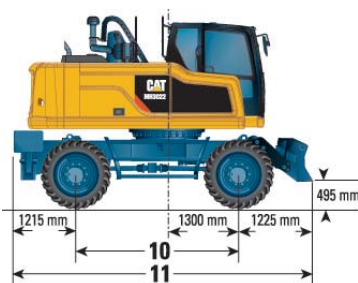

| Stick Length | mm | VA Boom | | | One-Piece Boom | | |
|--|----|---------|------|------|----------------|------|------|
| | | 2500 | 2800 | 3300 | 2500 | 2800 | 3300 |
| 1 Shipping Height with Falling Object Guard (highest point between boom and cab) | mm | 3375 | | | 3375 | | |
| 2 Shipping Length | mm | 8915 | 8890 | 8940 | 9025 | 9025 | 9040 |
| 3 Support Point | mm | 3625 | 3485 | 3270 | 3480 | 3300 | 3070 |
| 4 Tail Swing Radius | mm | | | | 2570 | | |
| 5 Counterweight Clearance | mm | | | | 1310 | | |
| 6 Cab Height with Hydraulic Cab Riser | | | | | | | |
| Cab Lowered – No Falling Object Guard | mm | | | | 3350 | | |
| Cab Lowered – with Falling Object Guard | mm | | | | 3375 | | |
| Cab Raised – with Falling Object Guard | mm | | | | 5775 | | |
| Cab Raised – without Falling Object Guard | mm | | | | 5645 | | |
| 7 Overall Machine Width | | | | | | | |
| Width with Outriggers on Ground | mm | | | | 3930 | | |
| Width with Outriggers Up | mm | | | | 2750 | | |
| Width with Blade | mm | | | | 2750 | | |
| 8 Height of Tray Group Flex | mm | | | | 3360 | | |
| 9 Maximum Outriggers Depth | mm | | | | 120 | | |
| 10 Wheel Base | mm | | | | 2750 | | |
| 11 Undercarriage length | | | | | | | |
| With 2 Sets of Outriggers Raised | mm | | | | 5040 | | |
| With 1 Set of Outriggers and Dozer Blade Raised | mm | | | | 5190 | | |
| 12 Undercarriage Clearance | mm | | | | 325 | | |

Note: Values with 11.00-20 pneumatic tires. For machines fitted with solid tires all vertical dimensions have to be reduced by 35 mm. For dimension 9 add 35 mm.

MH3022 Wheel Material Handler Specifications

Dimensions – With MH and MH Narrow Undercarriage

All dimensions are approximate.

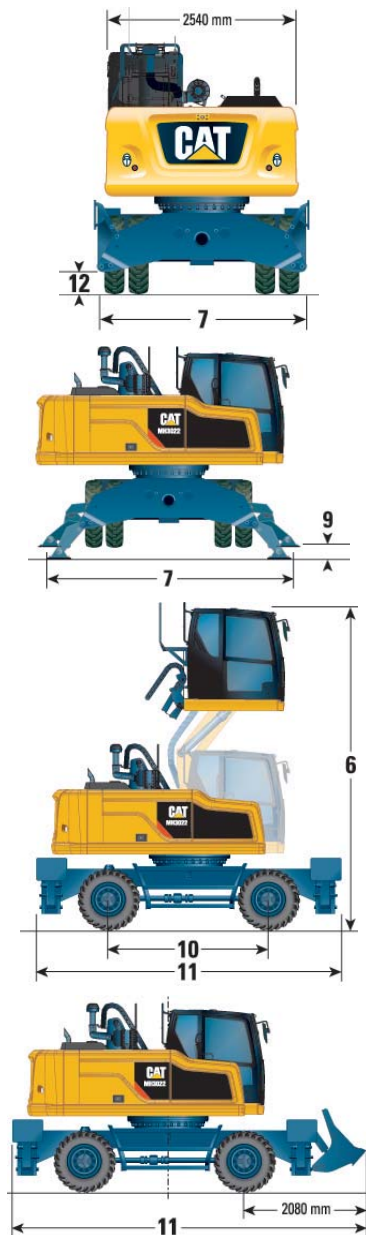
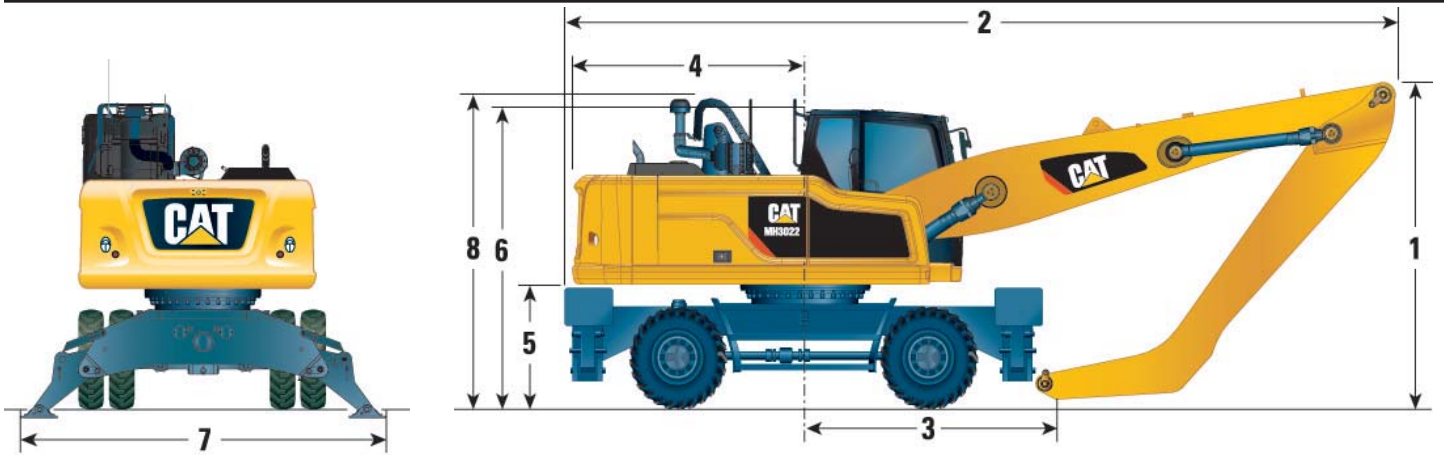

| | | MH Undercarriage | | MH Narrow UC* | |
|---|----|------------------|------------------|-----------------|------------------|
| | | Long MH Boom | Drop Nose | Short MH Boom | Drop Nose |
| Boom Length | mm | 6400 | | 5350 | |
| Stick Type | | Straight | Drop Nose | Straight | Drop Nose |
| Stick Length | mm | 4200 | 4900 | 4200 | 4900 |
| 1 Shipping Height with Falling Object Guard (highest point between boom and cab) | mm | 3340 | 3620 | 3340 | 4535 |
| 2 Shipping Length | mm | 9420 | 9280 | 8310 | 7885 |
| 3 Support Point | mm | 3230 | 2760 | 2190 | 2180 |
| 4 Tail Swing Radius | mm | 2570 | | | |
| 5 Counterweight Clearance | mm | 1275 | | | |
| 6 Cab Height with Hydraulic Cab Riser | | | | | |
| Cab Lowered – No Falling Object Guard | mm | 3315 | | | |
| Cab Lowered – with Falling Object Guard | mm | 3340 | | | |
| Cab Raised – with Falling Object Guard | mm | 5740 | | | |
| Cab Raised – No Falling Object Guard | mm | 5610 | | | |
| 7 Overall Machine Width | | | | | |
| Width with Outriggers on Ground | mm | 4360 | | 3680 | |
| Width with Outriggers Up | mm | 2990 | | 2550 | |
| Width with the Special Front Push Blade | mm | 2990 | | NA | |
| 8 Height of Tray Group Flex | mm | 3325 | | | |
| 9 Maximum Outriggers Depth | mm | 90 | | 120 | |
| 10 Wheel Base | mm | 2750 | | 2600 | |
| 11 Undercarriage Length | mm | 5250 | | 4900 | |
| With MH Undercarriage Front Push Blade | mm | 6080 | | NA | |
| 12 Undercarriage Clearance | mm | 245 | | 295 | |

*Dimensions with MH Narrow undercarriage, outriggers front and rear, and without work tool.

When the shipping height is over 4 m, the stick must be removed for transportation.

Note: Values are with 10.00-20 pneumatic or with solid tires. For machine fitted with 11.00-20 pneumatic tires and MH Undercarriage all vertical dimensions have to be increased by 35 mm. For dimension 9 reduce by 35 mm.

MH3022 Wheel Material Handler Specifications

Working Ranges

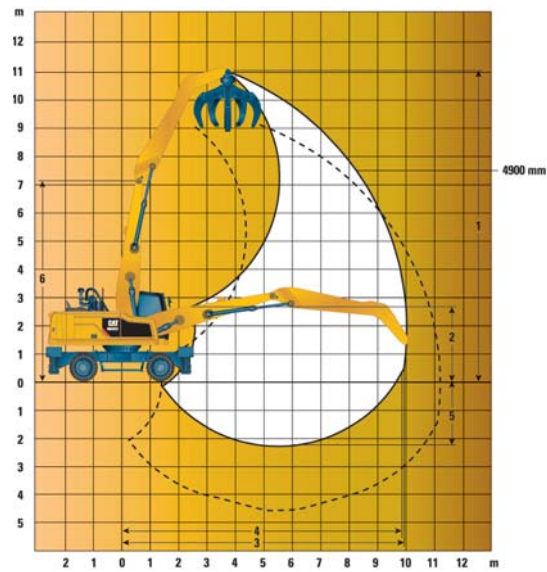
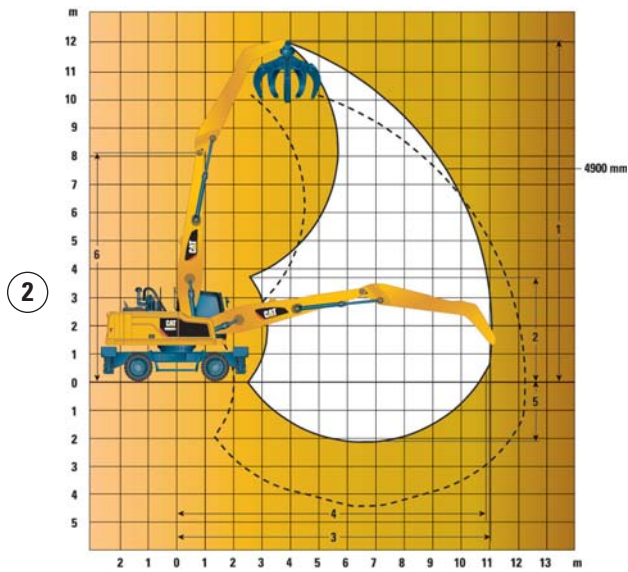
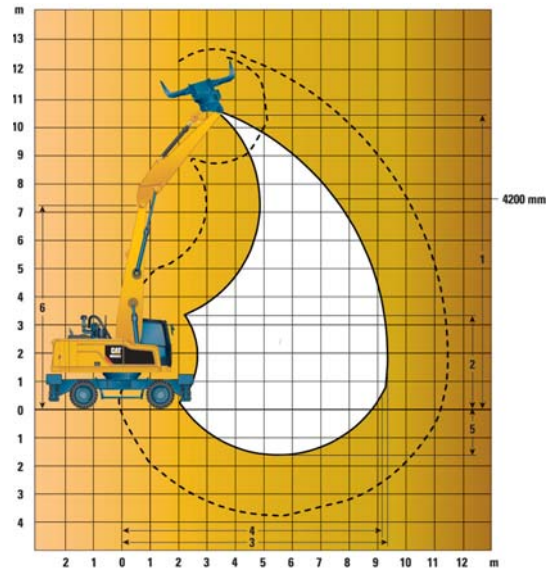
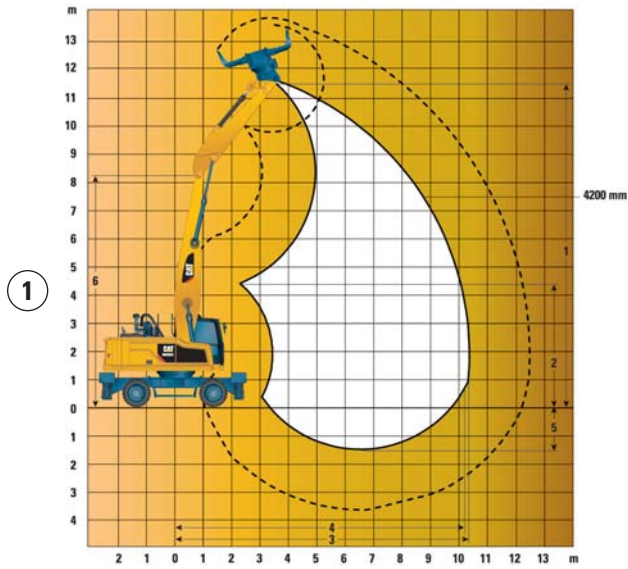

| | | MH3022 | | | |
|--|----|------------------------|------------------|------------------------------|------------------|
| | | ① | ② | ③ | ④ |
| Boom Type/Length | | MH Boom/6400 mm | | Short MH Boom/5350 mm | |
| Stick Length | mm | 4200 | 4900 | 4200 | 4900 |
| Stick Type | mm | Straight | Drop Nose | Straight | Drop Nose |
| 1 Maximum Height | mm | 11 520 | 12 065 | 10 445 | 11 020 |
| 2 Minimum Dump Height | mm | 4330 | 3680 | 3255 | 2635 |
| 3 Maximum Reach | mm | 10 345 | 11 005 | 9325 | 9990 |
| 4 Maximum Reach at Ground Level | mm | 10 175 | 10 845 | 9145 | 9815 |
| 5 Maximum Depth | mm | 1485 | 2185 | 1655 | 2325 |
| 6 Boom Pin Height | mm | 8235 | | 7160 | |

All dimensions refer to sticknose pin, with solid tires.

These dimensions are independent from the undercarriage type (whether it is MH or MH Narrow undercarriage).

MH3022 Wheel Material Handler Specifications

MH3022 Work Tool Offering Guide with Straight Sticks*

| Boom Length | | One-Piece Boom | | | | MH Boom (6.4 m) | | MH Boom (5.35 m) | |
|--------------------------|------------------|--|----------|----------|----------|-----------------|----------|------------------|----------|
| | | 3700 kg | | 4200 kg | | 3700 kg | 4200 kg | 3700 kg | 4200 kg |
| Counterweight | | (1) | | (1) | | (1) | (1) | (1) | (1) |
| Undercarriage/Outriggers | | (1) | | (1) | | (1) | (1) | (1) | (1) |
| Stick Length | | 2500 mm | 2800 mm | 2500 mm | 2800 mm | 4200 mm | 4200 mm | 4200 mm | 4200 mm |
| Stick Type | | Straight | Straight | Straight | Straight | Straight | Straight | Straight | Straight |
| Hydraulic Hammer | H115Es/H120Es | | | | | | | | |
| | H130Es | | | | | | | | |
| Multi-Processor | MP318 CC & D Jaw | | | | | | | | |
| | MP318 P Jaw | | | | | | | | |
| | MP318 U & S Jaw | | | | | | | | |
| Crusher | P315 | | | | | | | | |
| Pulverizer | P215 | | | | | | | | |
| Sorting Grapple | G315 GC | | | | | | | | |
| | G315B WH | | | | | | | | |
| | G315B-D/R | | | | | | | | |
| Scrap Shear | S320B | | | | | | | | |
| | S325B | | | | | | | | |
| Compactor Plate | CVP75 | | | | | | | | |
| Pin Grabber Coupler | CL-QC | These couplers are available for the MH3022 (with straight stick and linkage). | | | | | | | |
| Dedicated Quick Coupler | CW-30 | | | | | | | | |
| | CW-30S | | | | | | | | |

(1) MH undercarriage with 2 sets outriggers

Work tool is a match
 Pin-on or dedicated CW coupler
 Pin-on only
 Not recommended
 Boom mount

*Offerings not available in all areas. Matches are dependent on machine configurations. Consult your Cat dealer to determine what is offered in your area and for proper work tool match.

Fixed CAN: CW quick coupler adapter plates

MH3022 Work Tool Offering Guide with Drop Nose Sticks*

| Boom Length | | MH Boom (6.4 m) | | MH Boom (5.35 m) | |
|------------------------------------|--------------|----------------------|---------|----------------------|---------|
| | | 3700 kg | 4200 kg | 3700 kg | 4200 kg |
| Counterweight | | (1) | (1) | (1) | (1) |
| Undercarriage/Outriggers | | (1) | (1) | (1) | (1) |
| Stick Length | | 4900 mm | 4900 mm | 4900 mm | 4900 mm |
| Stick Type | | MH Stick (drop nose) | | MH Stick (drop nose) | |
| Orange Peel Grapple (4 or 5 tines) | GSH15B 600 L | | | | |
| | GSH15B 800 L | | | | |
| Orange Peel Grapple (5 tines) | GSM25 400 L | | | | |
| | GSM25 500 L | | | | |
| | GSM25 600 L | | | | |
| | GSM25 800 L | | | | |
| Clamshell Grapple | CTV15 1000 L | | | | |
| | CTV15 1200 L | | | | |
| | CTV15 1500 L | | | | |
| | CTV15 1700 L | | | | |
| | CTV15 1900 L | | | | |

(1) MH undercarriage with 2 sets outriggers

Maximum density 1.2 t/m³ (light material)
 Maximum density 1.8 t/m³ (standard material)

*Offerings not available in all areas. Matches are dependent on machine configurations. Consult your Cat dealer to determine what is offered in your area and for proper work tool match.

MH3022 Wheel Material Handler Specifications

Lift Capacities

All values are in kg, without work tool, with counterweight (4200 kg), heavy lift on.

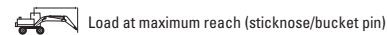
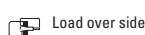
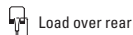
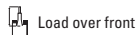

Undercarriage

MH (2.99 m) or MH Narrow (2.55 m)

Boom

5.35 m MH

Stick

4.2 m Straight Stick

| Load point height | Undercarriage configuration | 3000 mm | | | 4500 mm | | | 6000 mm | | | 7500 mm | | | 9000 mm | | | Load at maximum reach (sticknose/bucket pin) | | | mm |
|-------------------|----------------------------------|-----------------|----------------|----------------|-----------------|----------------|----------------|-----------------|----------------|----------------|-----------------|----------------|----------------|-----------------|----------------|----------------|--|----------------|----------------|------|
| | | Load over front | Load over rear | Load over side | Load over front | Load over rear | Load over side | Load over front | Load over rear | Load over side | Load over front | Load over rear | Load over side | Load over front | Load over rear | Load over side | Load over front | Load over rear | Load over side | |
| 9000 mm | SA – 2 sets stabilizers up | | | | *8550 | *8550 | 6950 | | | | | | | | | | *5750 | *5750 | 4400 | 5900 |
| | SA – 2 sets stabilizers down | | | | *8550 | *8550 | *8550 | | | | | | | | | | *5750 | *5750 | *5750 | |
| | Narrow – 2 sets stabilizers up | | | | *8500 | *8500 | 6200 | | | | | | | | | | 5400 | 5400 | 3950 | |
| | Narrow – 2 sets stabilizers down | | | | *8500 | *8500 | *8500 | | | | | | | | | | *5800 | *5800 | *5800 | |
| 7500 mm | SA – 2 sets stabilizers up | | | | | | | 5900 | 5900 | 4450 | | | | | | | 4150 | 4150 | 3050 | 7380 |
| | SA – 2 sets stabilizers down | | | | | | | *8250 | *8250 | *8250 | | | | | | | *5100 | *5100 | *5100 | |
| | Narrow – 2 sets stabilizers up | | | | | | | 5350 | 5350 | 3950 | | | | | | | 3750 | 3750 | 2700 | |
| | Narrow – 2 sets stabilizers down | | | | | | | *8200 | *8200 | 7150 | | | | | | | *5100 | *5100 | 5000 | |
| 6000 mm | SA – 2 sets stabilizers up | | | | | | | 5900 | 5900 | 4400 | 4050 | 4050 | 3000 | | | | 3350 | 3350 | 2450 | 8340 |
| | SA – 2 sets stabilizers down | | | | | | | *8600 | *8600 | *8600 | *7300 | *7300 | 6450 | | | | *4800 | *4800 | *4800 | |
| | Narrow – 2 sets stabilizers up | | | | | | | 5350 | 5350 | 3900 | 3650 | 3650 | 2650 | | | | 3050 | 3050 | 2150 | |
| | Narrow – 2 sets stabilizers down | | | | | | | *8600 | *8600 | 7100 | 6950 | 6950 | 4900 | | | | *4800 | *4800 | 4050 | |
| 4500 mm | SA – 2 sets stabilizers up | | | | 9200 | 9200 | 6750 | 5750 | 5750 | 4250 | 4000 | 4000 | 2950 | | | | 2950 | 2950 | 2150 | 8940 |
| | SA – 2 sets stabilizers down | | | | *11 100 | *11 100 | *11 100 | *8900 | *8900 | *8900 | *7350 | *7350 | 6400 | | | | *4750 | *4750 | *4750 | |
| | Narrow – 2 sets stabilizers up | | | | 8300 | 8300 | 6000 | 5200 | 5200 | 3800 | 3600 | 3600 | 2600 | | | | 2650 | 2650 | 1850 | |
| | Narrow – 2 sets stabilizers down | | | | *11 050 | *11 050 | *11 050 | *8900 | *8900 | 7000 | 6850 | 6850 | 4850 | | | | *4750 | *4750 | 3600 | |
| 3000 mm | SA – 2 sets stabilizers up | 17 750 | 17 750 | 12 050 | 8700 | 8700 | 6300 | 5500 | 5500 | 4050 | 3900 | 3900 | 2850 | 2900 | 2900 | 2100 | 2750 | 2750 | 2000 | 9260 |
| | SA – 2 sets stabilizers down | *18 000 | *18 000 | *18 000 | *12 250 | *12 250 | *12 250 | *9300 | *9300 | 9050 | *7400 | *7400 | 6250 | *5750 | *5750 | 4650 | *4850 | *4850 | 4450 | |
| | Narrow – 2 sets stabilizers up | 15 750 | 15 750 | 10 550 | 7850 | 7850 | 5600 | 4950 | 4950 | 3600 | 3500 | 3500 | 2500 | 2600 | 2600 | 1800 | 2450 | 2450 | 1700 | |
| | Narrow – 2 sets stabilizers down | *17 950 | *17 950 | *17 950 | *12 200 | *12 200 | 10 900 | *9300 | *9300 | 6750 | 6750 | 6750 | 4700 | 5000 | 5000 | 3500 | 4800 | 4800 | 3350 | |
| 1500 mm | SA – 2 sets stabilizers up | *11 900 | *11 900 | 10 650 | 8150 | 8150 | 5850 | 5250 | 5250 | 3850 | 3750 | 3750 | 2750 | 2850 | 2850 | 2050 | 2700 | 2700 | 1950 | 9320 |
| | SA – 2 sets stabilizers down | *11 900 | *11 900 | *11 900 | *12 950 | *12 950 | *12 950 | *9450 | *9450 | 8750 | *7250 | *7250 | 6150 | *5300 | *5300 | 4600 | *4750 | *4750 | 4400 | |
| | Narrow – 2 sets stabilizers up | *12 350 | *12 350 | 9200 | 7300 | 7300 | 5100 | 4750 | 4750 | 3350 | 3350 | 3350 | 2400 | 2550 | 2550 | 1750 | 2400 | 2400 | 1650 | |
| | Narrow – 2 sets stabilizers down | *12 350 | *12 350 | *12 350 | *12 950 | *12 950 | 10 300 | *9450 | *9450 | 6450 | 6600 | 6600 | 4600 | 4950 | 4950 | 3450 | 4700 | 4700 | 3300 | |
| 0 mm | SA – 2 sets stabilizers up | *6250 | *6250 | *6250 | 7750 | 7750 | 5450 | 5050 | 5050 | 3650 | 3650 | 3650 | 2650 | | | | | | | |
| | SA – 2 sets stabilizers down | *6250 | *6250 | *6250 | *12 250 | *12 250 | *12 250 | *8900 | *8900 | 8500 | *6600 | *6600 | 6000 | | | | | | | |
| | Narrow – 2 sets stabilizers up | *6250 | *6250 | *6250 | 6900 | 6900 | 4750 | 4550 | 4550 | 3150 | 3250 | 3250 | 2300 | | | | | | | |
| | Narrow – 2 sets stabilizers down | *6250 | *6250 | *6250 | *12 300 | *12 300 | 9850 | *8900 | *8900 | 6250 | 6500 | 6500 | 4500 | | | | | | | |
| -1500 mm | SA – 2 sets stabilizers up | | | | 7600 | 7600 | 5300 | 4950 | 4950 | 3550 | | | | | | | | | | |
| | SA – 2 sets stabilizers down | | | | *9850 | *9850 | *9850 | *7300 | *7300 | *7300 | | | | | | | | | | |
| | Narrow – 2 sets stabilizers up | | | | 6700 | 6700 | 4550 | 4400 | 4400 | 3050 | | | | | | | | | | |
| | Narrow – 2 sets stabilizers down | | | | *9950 | *9950 | 9650 | *7350 | *7350 | 6150 | | | | | | | | | | |

*Limited by hydraulic rather than tipping load.

Lift capacity ratings are based on ISO 10567:2007, they do not exceed 87% of hydraulic lifting capacity or 75% of tipping load. The load point is the center line of the bucket pivot mounting pin on the stick. The oscillating axle must be locked. Lifting capacities are based on the machine standing on a firm uniform supporting surface. For lifting capacity including bucket and/or quick coupler, the respective weight has to be subtracted from above values. The use of a work tool attachment point to handle/lift objects, could affect the machine lift performance.

Always refer to the appropriate Operation and Maintenance Manual for specific product information.

MH3022 Wheel Material Handler Specifications

Lift Capacities

All values are in kg, without work tool, with counterweight (4200 kg), heavy lift on.

 Load point height

 Load over front

 Load over rear

 Load over side

 Load at maximum reach (sticknose/bucket pin)

Undercarriage

























MH (2.99 m) or MH Narrow (2.55 m)

Boom

6.4 m MH

Stick

4.9 m MH

| Load point height | Undercarriage configuration | 3000 mm | | | 4500 mm | | | 6000 mm | | | 7500 mm | | | 9000 mm | | | 10 500 mm | | |  | | | mm | | | | | | | | | |
|-------------------|----------------------------------|---|---|---|---|---|---|---|---|---|---|---|---|---|---|---|---|---|---|---|---|---|----|---|---|---|--|-------|-------|-------|--------|--------|
| | |  |  |  |  |  |  |  |  |  |  |  |  |  |  |  |  |  |  |  |  |  | |  |  |  | | | | | | |
| 10 500 mm | SA – 2 sets stabilizers up | | | | | | | 6250 | 6250 | 4750 | | | | | | | | | | | | | | | | | | 5200 | 5200 | 3950 | 6700 | |
| | SA – 2 sets stabilizers down | | | | | | | *6500 | *6500 | *6500 | | | | | | | | | | | | | | | | | | *5250 | *5250 | *5250 | | |
| | Narrow – 2 sets stabilizers up | | | | | | | 5650 | 5650 | 4250 | | | | | | | | | | | | | | | | | | 4750 | 4750 | 3550 | | |
| | Narrow – 2 sets stabilizers down | | | | | | | *6450 | *6450 | *6450 | | | | | | | | | | | | | | | | | | *5300 | *5300 | *5300 | | |
| 9000 mm | SA – 2 sets stabilizers up | | | | | | | 6350 | 6350 | 4850 | 4450 | 4450 | 3400 | | | | | | | | | | | | | | | 3700 | 3700 | 2800 | 8320 | |
| | SA – 2 sets stabilizers down | | | | | | | *7850 | *7850 | *7850 | *6300 | *6300 | *6300 | | | | | | | | | | | | | | | *4700 | *4700 | *4700 | | |
| | Narrow – 2 sets stabilizers up | | | | | | | 5800 | 5800 | 4350 | 4050 | 4050 | 3000 | | | | | | | | | | | | | | | 3400 | 3400 | 2500 | | |
| | Narrow – 2 sets stabilizers down | | | | | | | *7850 | *7850 | 7600 | *6250 | *6250 | 5300 | | | | | | | | | | | | | | | *4700 | *4700 | 4450 | | |
| 7500 mm | SA – 2 sets stabilizers up | | | | | | | 6350 | 6350 | 4850 | 4450 | 4450 | 3400 | 3300 | 3300 | 2500 | | | | | | | | | | | | 3050 | 3050 | 2300 | 9420 | |
| | SA – 2 sets stabilizers down | | | | | | | *8200 | *8200 | *8200 | *7100 | *7100 | 6900 | *5500 | *5500 | 5100 | | | | | | | | | | | | *4400 | *4400 | *4400 | | |
| | Narrow – 2 sets stabilizers up | | | | | | | 5800 | 5800 | 4350 | 4050 | 4050 | 3050 | 3000 | 3000 | 2200 | | | | | | | | | | | | 2750 | 2750 | 2050 | | |
| | Narrow – 2 sets stabilizers down | | | | | | | *8150 | *8150 | 7600 | *7100 | *7100 | 5300 | 5450 | 5450 | 3950 | | | | | | | | | | | | *4400 | *4400 | 3650 | | |
| 6000 mm | SA – 2 sets stabilizers up | | | | | | | 6250 | 6250 | 4750 | 4400 | 4400 | 3350 | 3300 | 3300 | 2500 | | | | | | | | | | | | 2700 | 2700 | 2000 | 10 180 | |
| | SA – 2 sets stabilizers down | | | | | | | *8400 | *8400 | *8400 | *7200 | *7200 | 6800 | *6200 | *6200 | 5100 | | | | | | | | | | | | *4300 | *4300 | 4150 | | |
| | Narrow – 2 sets stabilizers up | | | | | | | 5700 | 5700 | 4250 | 4000 | 4000 | 3000 | 3000 | 3000 | 2200 | | | | | | | | | | | | 2400 | 2400 | 1750 | | |
| | Narrow – 2 sets stabilizers down | | | | | | | *8400 | *8400 | 7500 | *7200 | *7200 | 5250 | 5450 | 5450 | 3900 | | | | | | | | | | | | *4300 | *4300 | 3200 | | |
| 4500 mm | SA – 2 sets stabilizers up | | | | 9450 | 9450 | 7000 | 6000 | 6000 | 4550 | 4300 | 4300 | 3250 | 3250 | 3250 | 2450 | 2500 | 2500 | 1850 | 2450 | 2450 | 1800 | | | | | | | 2450 | 2450 | 1800 | 10 680 |
| | SA – 2 sets stabilizers down | | | | *11 150 | *11 150 | *11 150 | *8900 | *8900 | *8900 | *7350 | *7350 | 6700 | 6200 | 6200 | 5000 | 4850 | 4850 | 3950 | *4300 | *4300 | *4300 | | | | | | *4300 | *4300 | 3850 | | |
| | Narrow – 2 sets stabilizers up | | | | 8550 | 8550 | 6250 | 5450 | 5450 | 4050 | 3900 | 3900 | 2850 | 2900 | 2150 | 2250 | 2250 | 1650 | 2200 | 2200 | 1600 | | | | | | | | 2200 | 2200 | 1600 | |
| | Narrow – 2 sets stabilizers down | | | | *11 150 | *11 150 | *11 150 | *8850 | *8850 | 7250 | 7150 | 7150 | 5100 | 5350 | 5350 | 3850 | 4200 | 4200 | 3000 | 4100 | 4100 | 2950 | | | | | | | 4100 | 4100 | 2950 | |
| 3000 mm | SA – 2 sets stabilizers up | 17 550 | 17 550 | 11 900 | 8800 | 8800 | 6450 | 5700 | 5700 | 4250 | 4100 | 4100 | 3100 | 3150 | 3150 | 2350 | 2500 | 2500 | 1850 | 2350 | 2350 | 1700 | | | | | | | 2350 | 2350 | 1700 | 10 940 |
| | SA – 2 sets stabilizers down | *18 550 | *18 550 | *18 550 | *12 350 | *12 350 | *12 350 | *9350 | *9350 | 9250 | *7550 | *7550 | 6500 | 6050 | 6050 | 4950 | 4800 | 4800 | 3900 | *4400 | *4400 | 3650 | | | | | | | *4400 | *4400 | 3650 | |
| | Narrow – 2 sets stabilizers up | 15 550 | 15 550 | 10 400 | 7950 | 7950 | 5700 | 5150 | 5150 | 3750 | 3700 | 3700 | 2700 | 2850 | 2050 | 2250 | 2250 | 1600 | 2100 | 2100 | 1500 | | | | | | | | 2100 | 2100 | 1500 | |
| | Narrow – 2 sets stabilizers down | *18 500 | *18 500 | *18 500 | *12 350 | *12 350 | 11 000 | *9350 | *9350 | 6950 | 7000 | 7000 | 4950 | 5250 | 5250 | 3750 | 4150 | 4150 | 3000 | 3900 | 3900 | 2800 | | | | | | | 3900 | 3900 | 2800 | |
| 1500 mm | SA – 2 sets stabilizers up | | | | 8150 | 8150 | 5850 | 5400 | 5400 | 3950 | 3950 | 3950 | 2900 | 3050 | 3050 | 2250 | 2450 | 2450 | 1800 | 2300 | 2300 | 1650 | | | | | | | 2300 | 2300 | 1650 | 11 000 |
| | SA – 2 sets stabilizers down | | | | *13 000 | *13 000 | *13 000 | *9550 | *9550 | 8850 | *7500 | *7500 | 6300 | 5950 | 5950 | 4800 | *4700 | *4700 | 3850 | *4100 | *4100 | 3600 | | | | | | | *4100 | *4100 | 3600 | |
| | Narrow – 2 sets stabilizers up | | | | 7300 | 7300 | 5100 | 4850 | 4850 | 3500 | 3550 | 3550 | 2550 | 2750 | 1950 | 2200 | 2200 | 1550 | 2050 | 2050 | 1450 | | | | | | | | 2050 | 2050 | 1450 | |
| | Narrow – 2 sets stabilizers down | | | | *13 000 | *13 000 | 10 250 | *9550 | *9550 | 6600 | 6800 | 6800 | 4750 | 5150 | 5150 | 3650 | 4100 | 4100 | 2950 | 3850 | 3850 | 2750 | | | | | | | 3850 | 3850 | 2750 | |
| 0 mm | SA – 2 sets stabilizers up | *3500 | *3500 | *3500 | 7700 | 7700 | 5400 | 5150 | 5150 | 3700 | 3800 | 3800 | 2800 | 2950 | 2950 | 2150 | 2400 | 2400 | 1750 | | | | | | | | | | | | | |
| | SA – 2 sets stabilizers down | *3500 | *3500 | *3500 | *12 200 | *12 200 | *12 200 | *9150 | *9150 | 8600 | *7150 | *7150 | 6150 | *5550 | *5550 | 4750 | *4050 | *4050 | 3800 | | | | | | | | | | | | | |
| | Narrow – 2 sets stabilizers up | *3500 | *3500 | *3500 | 6850 | 6850 | 4700 | 4600 | 4600 | 3250 | 3400 | 3400 | 2400 | 2650 | 2650 | 1900 | 2150 | 2150 | 1500 | | | | | | | | | | | | | |
| | Narrow – 2 sets stabilizers down | *3500 | *3500 | *3500 | *12 350 | *12 350 | 9750 | *9200 | *9200 | 6300 | 6600 | 6600 | 4600 | 5050 | 5050 | 3600 | *4050 | *4050 | 2900 | | | | | | | | | | | | | |
| -1500 mm | SA – 2 sets stabilizers up | | | | 7450 | 7450 | 5200 | 5000 | 5000 | 3600 | 3700 | 3700 | 2700 | 2900 | 2900 | 2100 | | | | | | | | | | | | | | | | |
| | SA – 2 sets stabilizers down | | | | *9600 | *9600 | *9600 | *8000 | *8000 | *8000 | *6200 | *6200 | 6050 | *4650 | *4650 | *4650 | | | | | | | | | | | | | | | | |
| | Narrow – 2 sets stabilizers up | | | | 6650 | 6650 | 4500 | 4450 | 4450 | 3100 | 3300 | 3300 | 2350 | 2600 | 2600 | 1850 | | | | | | | | | | | | | | | | |
| | Narrow – 2 sets stabilizers down | | | | *9600 | *9600 | 9500 | *8000 | *8000 | 6150 | *6250 | *6250 | 4500 | *4700 | *4700 | 3550 | | | | | | | | | | | | | | | | |

*Limited by hydraulic rather than tipping load.

Lift capacity ratings are based on ISO 10567:2007, they do not exceed 87% of hydraulic lifting capacity or 75% of tipping load. The load point is the center line of the bucket pivot mounting pin on the stick. The oscillating axle must be locked. Lifting capacities are based on the machine standing on a firm uniform supporting surface. For lifting capacity including bucket and/or quick coupler, the respective weight has to be subtracted from above values. The use of a work tool attachment point to handle/lift objects, could affect the machine lift performance.

Always refer to the appropriate Operation and Maintenance Manual for specific product information.

MH3022 Wheel Material Handler Specifications

Lift Capacities

All values are in kg, without work tool, with counterweight (4200 kg), heavy lift on.

 Load point height

 Load over front

 Load over rear

 Load over side

 Load at maximum reach (sticknose/bucket pin)

Undercarriage















MH (2.99 m) or MH Narrow (2.55 m)

Boom

6.4 m MH

Stick

4.2 m Straight Stick

|  | Undercarriage configuration | 3000 mm | | | 4500 mm | | | 6000 mm | | | 7500 mm | | | 9000 mm | | |  | | | mm |
|--|----------------------------------|---|---|---|---|---|---|---|---|---|---|---|---|---|---|---|---|---|---|------|
| | |  |  |  |  |  |  |  |  |  |  |  |  | | | | | | | |
| 9000 mm | SA – 2 sets stabilizers up | | | | | | | 5900 | 5900 | 4400 | | | | | | | 4050 | 4050 | 3000 | 7420 |
| | SA – 2 sets stabilizers down | | | | | | | *8100 | *8100 | *8100 | | | | | | | *5300 | *5300 | *5300 | |
| | Narrow – 2 sets stabilizers up | | | | | | | 5350 | 5350 | 3900 | | | | | | | 3700 | 3700 | 2650 | |
| | Narrow – 2 sets stabilizers down | | | | | | | *8050 | *8050 | 7150 | | | | | | | *5300 | *5300 | 4950 | |
| 7500 mm | SA – 2 sets stabilizers up | | | | | | | 5900 | 5900 | 4400 | 4050 | 4050 | 3000 | | | | 3150 | 3150 | 2250 | 8640 |
| | SA – 2 sets stabilizers down | | | | | | | *8250 | *8250 | *8250 | *7000 | *7000 | 6450 | | | | *4900 | *4900 | *4900 | |
| | Narrow – 2 sets stabilizers up | | | | | | | 5350 | 5350 | 3950 | 3650 | 3650 | 2650 | | | | 2800 | 2800 | 2000 | |
| | Narrow – 2 sets stabilizers down | | | | | | | *8250 | *8250 | 7150 | 6950 | 6950 | 4900 | | | | *4900 | *4900 | 3800 | |
| 6000 mm | SA – 2 sets stabilizers up | | | | 9350 | 9350 | 6900 | 5800 | 5800 | 4300 | 4000 | 4000 | 2950 | 2900 | 2100 | 2650 | 2650 | 1900 | 9460 | |
| | SA – 2 sets stabilizers down | | | | *10 600 | *10 600 | *10 600 | *8500 | *8500 | *8500 | *7050 | *7050 | 6400 | 5850 | 5850 | 4700 | *4750 | *4750 | | 4300 |
| | Narrow – 2 sets stabilizers up | | | | 8450 | 8450 | 6100 | 5250 | 5250 | 3800 | 3600 | 3600 | 2600 | 2600 | 1800 | 2350 | 2350 | 1650 | | |
| | Narrow – 2 sets stabilizers down | | | | *10 600 | *10 600 | *10 600 | *8450 | *8450 | 7050 | 6900 | 6900 | 4850 | 5050 | 3550 | 4600 | 4600 | 3250 | | |
| 4500 mm | SA – 2 sets stabilizers up | *14 500 | *14 500 | 12 500 | 8850 | 8850 | 6450 | 5550 | 5550 | 4100 | 3900 | 3900 | 2850 | 2850 | 2050 | 2350 | 2350 | 1650 | 10 000 | |
| | SA – 2 sets stabilizers down | *14 500 | *14 500 | *14 500 | *11 500 | *11 500 | *11 500 | *8850 | *8850 | *8850 | *7150 | *7150 | 6250 | 5800 | 4650 | *4750 | *4750 | 3900 | | |
| | Narrow – 2 sets stabilizers up | *14 250 | *14 250 | 10 950 | 8000 | 8000 | 5700 | 5000 | 5000 | 3600 | 3500 | 3500 | 2500 | 2550 | 1750 | 2100 | 2100 | 1400 | | |
| | Narrow – 2 sets stabilizers down | *14 250 | *14 250 | *14 250 | *11 500 | *11 500 | 11 100 | *8850 | *8850 | 6800 | 6750 | 6750 | 4700 | 5000 | 3500 | 4200 | 4200 | 2900 | | |
| 3000 mm | SA – 2 sets stabilizers up | | | | 8200 | 8200 | 5850 | 5250 | 5250 | 3800 | 3700 | 3700 | 2700 | 2800 | 2000 | 2200 | 2200 | 1550 | 10 280 | |
| | SA – 2 sets stabilizers down | | | | *12 450 | *12 450 | *12 450 | *9200 | *9200 | 8750 | *7200 | *7200 | 6100 | 5700 | 4550 | *4500 | *4500 | 3700 | | |
| | Narrow – 2 sets stabilizers up | | | | 7350 | 7350 | 5100 | 4700 | 4700 | 3350 | 3350 | 2350 | 2450 | 1700 | 1950 | 1950 | 1300 | | | |
| | Narrow – 2 sets stabilizers down | | | | *12 400 | *12 400 | 10 350 | *9150 | *9150 | 6450 | 6600 | 6600 | 4550 | 4900 | 3400 | 3950 | 3950 | 2750 | | |
| 1500 mm | SA – 2 sets stabilizers up | | | | 7550 | 7550 | 5300 | 4950 | 4950 | 3550 | 3550 | 3550 | 2550 | 2700 | 1900 | 2150 | 2150 | 1500 | 10 340 | |
| | SA – 2 sets stabilizers down | | | | *12 450 | *12 450 | *12 450 | *9100 | *9100 | 8400 | *7000 | *7000 | 5900 | *5450 | *5450 | 4450 | *3950 | *3950 | | 3600 |
| | Narrow – 2 sets stabilizers up | | | | 6700 | 6700 | 4550 | 4400 | 4400 | 3050 | 3150 | 3150 | 2200 | 2400 | 1600 | 1900 | 1900 | 1250 | | |
| | Narrow – 2 sets stabilizers down | | | | *12 500 | *12 500 | 9650 | *9100 | *9100 | 6150 | 6400 | 6400 | 4400 | 4800 | 3300 | 3900 | 3900 | 2650 | | |
| 0 mm | SA – 2 sets stabilizers up | | | | 7200 | 7200 | 4950 | 4750 | 4750 | 3350 | 3450 | 3450 | 2400 | 2650 | 1850 | | | | | |
| | SA – 2 sets stabilizers down | | | | *9400 | *9400 | *9400 | *8350 | *8350 | 8150 | *6400 | *6400 | 5800 | *4800 | *4800 | 4400 | | | | |
| | Narrow – 2 sets stabilizers up | | | | 6350 | 6350 | 4250 | 4200 | 4200 | 2850 | 3050 | 3050 | 2050 | 2350 | 1550 | | | | | |
| | Narrow – 2 sets stabilizers down | | | | *9450 | *9450 | 9250 | *8400 | *8400 | 5900 | 6250 | 6250 | 4250 | 4750 | 3250 | | | | | |

*Limited by hydraulic rather than tipping load.

Lift capacity ratings are based on ISO 10567:2007, they do not exceed 87% of hydraulic lifting capacity or 75% of tipping load. The load point is the center line of the bucket pivot mounting pin on the stick. The oscillating axle must be locked. Lifting capacities are based on the machine standing on a firm uniform supporting surface. For lifting capacity including bucket and/or quick coupler, the respective weight has to be subtracted from above values. The use of a work tool attachment point to handle/lift objects, could affect the machine lift performance.

Always refer to the appropriate Operation and Maintenance Manual for specific product information.

Standard Equipment

Standard equipment may vary. Consult your Cat dealer for details.

ELECTRICAL

- Alternator, 115A
- Heavy Duty maintenance free batteries
- Lighting
 - Boom and stick LED working light
 - One LED light on the counterweight for the rear camera, and one on the right for the sideview camera.
 - Cab LED interior dome light
 - Rooding lights two front, halogen
 - Rooding lights two rear, LED
 - Working LED lights, cab mounted (two front and one rear), compatible with Falling Objects Guards
- Main shut-off switch
- Signal/warning horn

ENGINE

- Cat C7.1 ACERT technology engine meets Stage IV emission standards
- Aftertreatment technologies including the Cat Clean Emission Module (Cat CEM) package
- Air filter
- 3000 m altitude capability without de-rate
- Automatic Engine Speed Control (AESC), including One Touch Low Idle
- Engine Idle Shutdown (EIS)
- Automatic starting aid
- Fuel filter
- Fuel/water separator with water in fuel switch
- 48° C ambient cooling capability without de-rate
- Power mode selector
- Electric fuel priming pump

HYDRAULICS

- Adjustable hydraulic sensitivity
- Cat XT™-6 ES hoses
- Control circuits (standard and optional, depending on boom/stick/linkage choice):
 - Medium pressure
 - Two-way, medium pressure circuit, for rotating or tilting of attachments
- Heavy lift mode
- Load-sensing hydraulic system
- Quick disconnect couplings
- Separate swing pump
- Electric Pump Control (EPC)
- Boom Lowering Check Valve (BLCV), including overload warning device
- Stick Lowering Check Valve (SLCV)

OPERATOR STATION

- Additional color monitor for cameras, split-screen display for both cameras' view
- Adjustable armrests
- Air conditioner, heater and defroster with automatic climate control
- Beverage cup/can holder
- Bolt-on top/front guards capability
- Bottle holder
- Bottom mounted, intermittent (four speeds), parallel wiping system, covering upper and lower windshield glass
- CD/MP3 radio (12V) including speakers and 12V converter
- Coat hook
- Cruise control system
- Floor mat, washable, with storage compartment
- Fully adjustable suspension seat
- Hydraulic cab riser

- Instrument panel and gauges, full graphic and color display
 - Information and warning messages in local language
 - Gauges for fuel and DEF levels, engine coolant and hydraulic oil temperature
 - Filters/fluids change interval, working hours
 - Indicators for headlights, turning signal, low fuel, engine dial setting
 - Clock with 10-day backup battery
- Interior LED lighting with door switch
- Joysticks, pilot operated with one proportional slider
- Laminated front windshield
- Left side console, tiltable, with lock out for all controls
- Cigarette lighter (24V)
- Literature holder in right console
- Mobile phone holder
- Parking brake
- Pin code type engine start prevention, integrated into the monitor
- Power supply, 12V-10A
- Rear window (tempered glass)/emergency exit, with hammer
- Retractable seat belt, integrated into the seat
- Seat belt indicator and alarm
- Skylight, laminated glass
- Sliding door windows
- Steering column, adjustable angle and height
- Step, integrated into the skirt
- Storage area suitable for a lunch box
- Sunshade for windshield and skylight
- Safety lever, integrated into the left console
- Sealed cab, with positive filtered, variable speed ventilation

Continued on next page

Standard Equipment

Standard equipment may vary. Consult your Cat dealer for details.

UNDERCARRIAGE

- Automatic brake and axle lock
- Electronic swing and travel lock
- Creeper speed
- Four wheel drive
- Heavy-duty axles, advanced travel motor, adjustable braking force and disc brake system
- Oscillating front axle, lockable, with remote greasing point
- Steps, wide, left and right
- Tool boxes, left and right, in undercarriage
- Two-speed hydrostatic transmission
- One-piece drive shaft, with 1,000 hours greasing intervals

OTHER EQUIPMENT

- Auto-lube system (implements and swing gear)
- Automatic swing brake
- Capability to add auxiliary hydraulic circuit
- Cat Electronic Technician capability (ET)
- Counterweight, 3700 kg
- Door locks and cap locks with Cat one-key security system
- Mirrors, wide angle, frame and cab
- Product Link

- Cameras
 - Rear mounted wide angle camera, integrated into the counterweight
 - Right side wide angle camera, mounted on the cooling hood.
- S·O·SSM Quick Sampling valves for engine oil, hydraulic oil and coolant
- Engine emergency shutoff switch
- Spacer rings for tires
- Cooling package, fine mesh screen, and engine air precleaner

Optional Equipment

Optional equipment may vary. Consult your Cat dealer for details.

AUXILIARY CONTROLS AND LINES

- Auxiliary boom and stick lines
- Control circuits (standard and optional, depending on boom/stick/linkage choice):
 - Tool control/multi function
 - One/two-way high pressure for hammer application or opening and closing of an attachment
 - Programmable flow and pressure for up to 10 work tools – selection via monitor
 - Quick coupler circuit and lines for hydraulic quick coupler (both Cat pin grabber and dedicated/CW quick couplers, controlled by a dedicated switch)
- SmartBoom

HYDRAULICS

- Cat BIO HYDO Advanced HEES biodegradable hydraulic oil

FRONT LINKAGE

- VA boom (5260 mm):
 - Straight stick (2500, 2800 mm)
 - Industrial stick (3300 mm)
- One-Piece boom (5350 mm):
 - Straight stick (2500, 2800 mm)
 - Industrial stick (3300 mm)
- Material Handling boom (6400 mm):
 - Drop nose MH stick (4900 mm)
 - Straight MH stick (4200 mm)
- Material Handling boom (5350 mm):
 - Drop nose MH stick (4900 mm)
 - Straight MH stick (4200 mm)

ELECTRICAL

- Adjustable travel alarm
- Rotating beacon
- Generator, 15 kW
- Kit, generator, 15 kW***

OPERATOR STATION

- Top/front guards
- Joystick steering
- Advanced joysticks with two proportional sliders
- High pressure auxiliary pedal
- Seat, adjustable high-back, with vertical and horizontal air-suspension and head rest
 - Automatic weight adjustment, mechanical lumbar support, passive climate system, seat cushion length/angle adjustment and heated seat (Comfort)
 - Automatic height and weight adjustment, active climate system, premium microfiber seat fabric, pneumatic lumbar support, seat cushion length and angle adjustment and adjustable dampening, heated and ventilated (Deluxe)
- Visor for rain protection
- Windshield
 - One-piece, impact resistant, laminated windshield and skylight (EN356 P5A standards, 10 mm)
 - 70/30 split, openable. Two-parts split, fixed, high impact resistant, with skylight (EN356 P8B standards, 26 mm)
- Mirrors, electrically adjustable and heated, frame and cab

TIRES*

- Dual pneumatic 10.00-20
- Dual pneumatic 11.00-20
- Dual solid rubber, 10.00-20

UNDERCARRIAGE

- MH Narrow undercarriage with four welded outriggers
- MH undercarriage with four welded outriggers
- MH undercarriage with four welded outriggers and front mounted blade
- Standard undercarriage, with outriggers (front and/or rear), dozer blade (front or rear)
- Easy Cab Access Package with ladder

OTHER EQUIPMENT

- Bucket linkages
- Cat Machine Security System
- Counterweight, 4200 kg
- Hydraulic quick coupler
- Maximum speed 20 km/h or 25 km/h**
- Refueling pump with dedicated tray for the hose
- Waste Handling Package, adds a reversing fan and vibrating grill to the cooling protection package
- Cab pre-filtration system
- Attachments (see p. 29-30)

*Dual Pneumatic 10.00-20 not compatible with MH undercarriage

Dual Pneumatic 11.00-20 not compatible with MH narrow undercarriage

**25 km/h not compatible with solid tires

***Available starting 2017

For more complete information on Cat products, dealer services, and industry solutions, visit us on the web at www.cat.com

AEHQ7901
(Europe)

© 2016 Caterpillar
All rights reserved

Materials and specifications are subject to change without notice. Featured machines in photos may include additional equipment. See your Cat dealer for available options.

CAT, CATERPILLAR, SAFETY.CAT.COM, their respective logos, "Caterpillar Yellow" and the "Power Edge" trade dress, as well as corporate and product identity used herein, are trademarks of Caterpillar and may not be used without permission.

VisionLink is a trademark of Trimble Navigation Limited, registered in the United States and in other countries.

