

313D GC Series 2

Hydraulic Excavator

2017



Engine

Engine Model	Cat® C4.4	
Engine Power (ISO 14396)	75 kW	100 hp
Net Power (SAE J1349/ISO 9249)*	68 kW	91 hp

*See page 5

Weights

Minimum Operating Weight	12 500 kg	27,557 lb
Maximum Operating Weight	13 400 kg	29,542 lb

313D GC Series 2 Features

Engine and Hydraulics

The Cat 313D GC Series 2 delivers excellent performance and lower operating costs. Unmatched versatility, improved controllability, easy operation and a comfortable operator station help to make the 313D GC Series 2 an industry-leading performer.

Structures

Caterpillar design and manufacturing techniques assure outstanding durability and service life.

Operator Station

The spacious cab features excellent visibility and easy-to-access switches. The monitor features a full-color graphical display that is user intuitive and highly visual with built-in pre-start machine checks. Overall, the new cab provides a comfortable working environment for efficient day-long operation.

Service and Maintenance

This machine has been designed so that routine service and maintenance can be completed quickly and easily to help reduce ownership costs. Convenient access points with extended intervals and advanced filtration keep downtime to a minimum.

Complete Customer Support

Your Cat dealer offers a wide range of services that can be set up under a customer support agreement when you purchase your equipment.

Cat® 313D GC Series 2 Total Solutions

Caterpillar and its extensive dealer network offer a wide variety of solutions designed to meet the unique needs of your business.

Contents

Operator Station.....	4
Engine	5
Hydraulics	6
Undercarriage and Structures	7
Front Linkage	7
Versatility.....	8
Service and Maintenance	9
Complete Customer Support.....	10
Specifications.....	11
Standard Equipment.....	22
Notes.....	23





Good machine performance combined with low owning and operating costs make the Cat 313D GC Series 2 hydraulic excavator the preferred machine of choice for utility contractors. Unmatched versatility, improved controllability, easy operation, and a comfortable, redesigned operator station help make the 313D GC Series 2 an industry-leading performer.

Operator Station

Enhanced comfort, operation and visibility.

Operator Station

The ergonomically designed operator station is spacious, quiet, and comfortable, assuring high productivity during a long work day. All switches are located on the right-hand console for convenient access.

Monitor

The monitor is a full-color Liquid Crystal Display (LCD) that can be adjusted to minimize sun glare and has the capability of displaying information in Chinese and 26 other languages.

Joystick Control

Low-effort pilot-operated joystick controls are designed to match the operator's natural wrist and arm position for maximum comfort and minimum fatigue.

Seat

The standard suspension seat provides a variety of adjustments to suit the operator's size and weight including fore/aft height and weight. Wide adjustable armrests and a seat belt are also included.

Console

The consoles feature a simple functional design to reduce operator fatigue, ease of switch operation, and excellent visibility. Both consoles have attached armrests with tilting adjustments.

Cab Exterior

The cab shell features thick steel tubing along the bottom perimeter of the cab, improving resistance to fatigue and vibration.



Cab Mounts

The cab shell is attached to the frame with viscous rubber cab mounts, which dampen vibrations and sound levels while enhancing operator comfort.

Windows

To maximize visibility, all glass is affixed directly to the cab, eliminating window frames. The upper front windshield opens, closes, and stores on the roof above the operator with a one-touch action release system.

Wipers

Pillar-mounted wipers increase the operator's viewing area and offer continuous and intermittent modes.

Engine

The Cat[®] C4.4 engine optimizes performance and meets emission standards.

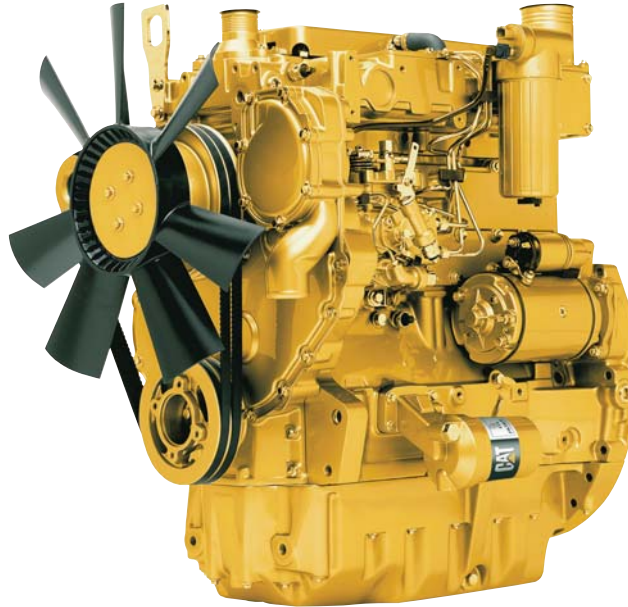

The Cat C4.4 engine has been designed to meet U.S. EPA Tier 3, EU Stage IIIA equivalent and China Nonroad Stage III emission standards. This engine incorporates a time-proven mechanical governor and a low-pressure fuel injection system that are major contributors to the improvement of fuel system robustness, high fuel efficiency, and ease of troubleshooting. High filtration performance from the primary filter incorporating a water separator and a secondary filter also help to improve fuel filtration system reliability.

Automatic Engine Control and Fuel Delivery

Configured to operate at a maximum speed of 1,650 rpm with a net power of 55 kW (74 hp), the 313D2 GC has been designed with fuel economy in mind; it burns up to 15% less fuel when compared to the 313D2.

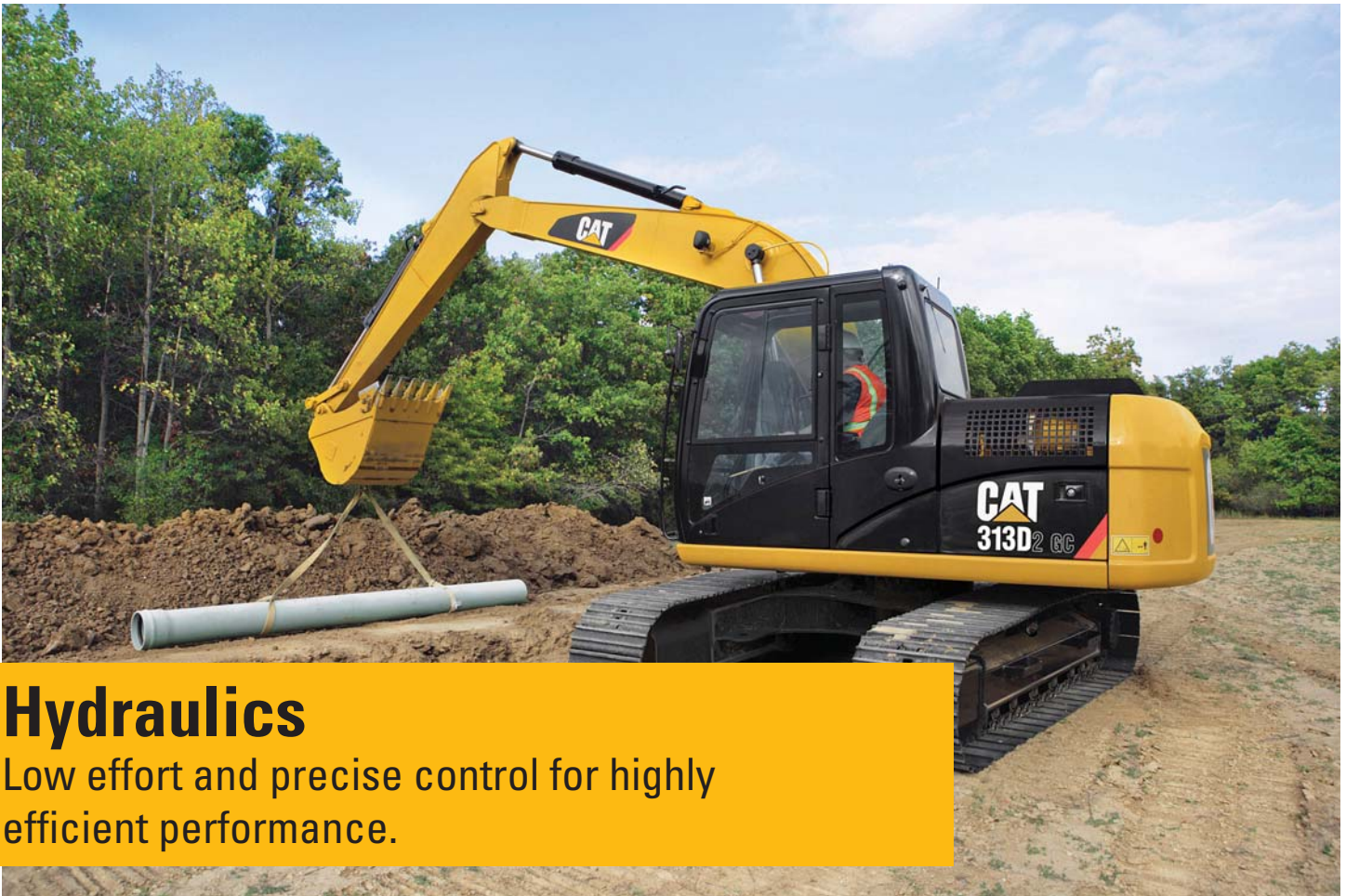

Hydraulics

Low effort and precise control for highly efficient performance.

Outstanding Performance

The 313D GC Series 2 hydraulic system is designed for high efficiency and performance. Auxiliary hydraulic and electrical lines are routed to the boom foot making installation of hydraulic circuits much easier. This compact design utilizes short tubes and lines to reduce friction and pressure drops, resulting in a more efficient use of power.

- Hydraulic snubbers at the rod end of the boom cylinders and both ends of the stick cylinders cushion shock, reduce sound, and increase cylinder life.
- Flow is reduced to a minimum when controls are in neutral to reduce fuel consumption and extend component life.
- A hydraulic cross-sensing system uses two hydraulic pumps up under all operating conditions, improving productivity with faster implement speeds and quicker, stronger pivot turns.

Boom and Stick Regeneration Circuit

The boom and stick regeneration circuit saves energy during boom-down and stick-in operation, increasing efficiency and lowering operating costs.

Easy Operation

Work mode and power mode switches have been eliminated making full power available at all times. Operators do not need to learn different modes. An automatic boom and swing priority function automatically selects the best mode based on joystick movement.

Undercarriage and Structures

Strong, stable and easy to maneuver.

Caterpillar uses advanced engineering and software to analyze all structures, creating a durable, reliable machine for robust applications. More than 70 percent of the structural welds are robotic and achieve additional penetration over manual welds. These structural components and undercarriage are the backbone of the machine's durability.

Carbody Design

X-shaped, box-section carbody provides excellent resistance to torsional bending. Robot-welded track roller frames are press-formed, pentagonal units that deliver exceptional strength and service life.

Grease Lubricated Track

Grease lubricated track seals protect the track link and deliver long track link pin and bushing inner wear.

Travel Motors

Travel motors with automatic speed selection let the 313D GC Series 2 automatically change up and down from high and low speeds in a smooth, controlled manner.



Front Linkage

Reliable, durable and versatile.

Cat booms and sticks are welded, box-section structures with thick multi-plate high-strength steel fabrications. Service intervals are extended with self-lubricating bearings that resist corrosion and galling for superior durability.

Stick

A 2.5 m (8'2") reach stick has new forged parts, and welded joints for increased durability, digging force, and lifting capability.

Boom

A 4.65 m (15'3") reach boom features parts made from a new forging pattern. A light attached to the left side offers improved visibility in dark and low-light conditions.





Versatility

More options for more work.

Cat Buckets and Cat Ground Engaging Tools (GET) are designed and matched to the machine ensuring optimal performance and fuel consumption. They are built to Caterpillar specifications guaranteeing quality and durability, whatever the application.

Utility Buckets

For digging in low-impact, low abrasive material such as dirt, loam and clay.

- Shallow profile is easier to empty sticky materials.
- Lightest structures decrease load time and increase the weight that can be lifted.
- Pre-drilled sidebars for optional sidecutters.



Service and Maintenance

Simplified service and maintenance features save you time and money.



Ground Level Service

The design and layout of the 313D GC Series 2 was made with the service technician in mind. Most service locations are easily accessible at ground level allowing service and maintenance to get completed quickly and efficiently.

Pump Compartment

A service door on the right side of the upper structure allows ground-level access to the pump, pilot filter, drain filter, and the engine oil filter.

Radiator Compartment

The left service door allows easy access to the engine radiator, oil cooler, air-to-air-aftercooler, water separator and first and second fuel filter. A reserve tank and drain cock are attached to the radiator for simplified maintenance.

The air filter features a double-element construction for superior cleaning efficiency. When the air cleaner plugs, a warning is displayed on the monitor screen inside the cab.

Hydraulic Filter

The hydraulic return filter is an in-tank design with a service life of 2,000 hours. A sensor indicates through the in-cab monitor when the filter is plugged and needs to be replaced.

Greasing Points

A concentrated remote greasing block on the boom delivers grease to hard-to-reach locations on the front.

Fan Guard

The engine radiator fan is 180 degree enclosed by fine wire mesh, reducing the risk of an accident.

Anti-Skid Plate

Anti-skid plate covers top of storage box and upper structure to prevent slipping during maintenance.

Diagnostics and Monitoring

The 313D GC Series 2 is equipped with S-O-SSM sampling ports and hydraulic test ports for the hydraulic system, engine oil, and for coolant. A test connection for the Caterpillar Electronic Technician (Cat ET) service tool is located behind the cab.

Extended Service Interval

313D GC Series 2 service and maintenance intervals are long which results in reduced service time and increased machine availability.



Complete Customer Support

Cat dealer services help you operate longer with lower costs.

Product Support

You will find nearly all parts at our dealer parts counter. Cat dealers utilize a worldwide computer network to find in-stock parts to minimize machine downtime. Save money with remanufactured components.

Machine Selection

Make detailed comparisons of the machines you are considering before you buy. What are the job requirements, machine attachments and operating hours? What production is needed? Your Cat dealer can provide recommendations.

Maintenance Services

Repair option programs guarantee the cost of repairs up front. Condition monitoring services and diagnostic programs such as scheduled oil sampling, coolant sampling, and technical analysis help you avoid unscheduled repairs.

Customer Support Agreements

Cat dealers offer a variety of product support agreements, and work with customers to develop a plan that best meets specific needs. These plans can cover the entire machine, including attachments, to help protect the customer's investment.

Replacement

Repair, rebuild, or replace? Your Cat dealer can help you evaluate the cost involved so you can make the right choice.

313D GC Series 2 Hydraulic Excavator Specifications

Engine

Engine Model	Cat C4.4	
Engine Power – ISO 14396	75 kW	100 hp
Net Power – SAE J1349/ISO 9249	68 kW	91 hp
Engine Power at 1,650 rpm	55 kW	74 hp
Bore	105 mm	4.13 in
Stroke	127 mm	5 in
Displacement	4.4 L	268.5 in ³

- Net power advertised is the power available at the flywheel when the engine is equipped with fan, air cleaner, muffler and alternator.
- No engine derating required below 2300 m (7,546 ft) altitude.
- The 313D GC Series 2 meets Tier 3, Stage IIIA equivalent and China Nonroad Stage III emission standards.
- The 313D GC Series 2 meets China Stage 1 of sound regulation.

Weights

Operating Weight – UD 0.53 m ³ (0.69 yd ³) Bucket	12 500 kg*	27,557.79 lb*
Operating Weight – GD 0.65 m ³ (0.86 yd ³) Bucket	12 600 kg** - 13 400 kg***	27,778 lb** - 29,542 lb***

*Standard undercarriage: 500 mm (20") shoes, 4.65 m (15'3") reach boom, R2.5 (8'2") stick, UD 0.53 m³ (0.69 yd³) bucket.

**Standard undercarriage: 500 mm (20") shoes, 4.65 m (15'3") reach boom, R2.5 (8'2") stick, GD 0.65 m³ (0.86 yd³) bucket.

***Standard undercarriage: 770 mm (30") shoes, 4.65 m (15'3") reach boom, R3.0 (9'10") stick, GD 0.65 m³ (0.86 yd³) bucket.

Swing Mechanism

Swing Speed	11.2 rpm	
Swing Torque	30.9 kN·m	22,825 lbf·ft

Drive

Maximum Travel Speed	5.1 km/h	3.2 mph
Maximum Drawbar Pull	114 kN	25,628 lbf

Hydraulic System

Main System – Maximum Flow (Total)	232 L/min	61.3 gal/min
Swing System – Maximum Flow	116 L/min	30.6 gal/min
Maximum Pressure – Equipment	30 500 kPa	4,424 psi
Maximum Pressure – Travel	35 000 kPa	5,076 psi
Maximum Pressure – Swing	23 000 kPa	3,336 psi
Pilot System – Maximum Flow	21.9 L/min	5.79 gal/min
Pilot System – Maximum Pressure	4120 kPa	598 psi
Boom Cylinder – Bore	110 mm	4.33 in
Boom Cylinder – Stroke	1015 mm	40 in
Stick Cylinder – Bore	120 mm	4.72 in
Stick Cylinder – Stroke	1197 mm	47.12 in
Bucket Cylinder – Bore	100 mm	3.93 in
Bucket Cylinder – Stroke	939 mm	37 in

Service Refill Capacities

Fuel Tank Capacity	250 L	66.05 gal
Cooling System	18 L	4.76 gal
Engine Oil (with filter)	16 L	4.23 gal
Swing Drive	3 L	0.8 gal
Final Drive (each)	3 L	0.8 gal
Hydraulic System (including tank)	86 L	22.7 gal
Hydraulic Tank	73 L	19.3 gal

313D GC Series 2 Hydraulic Excavator Specifications

Dimensions

All dimensions are approximate.

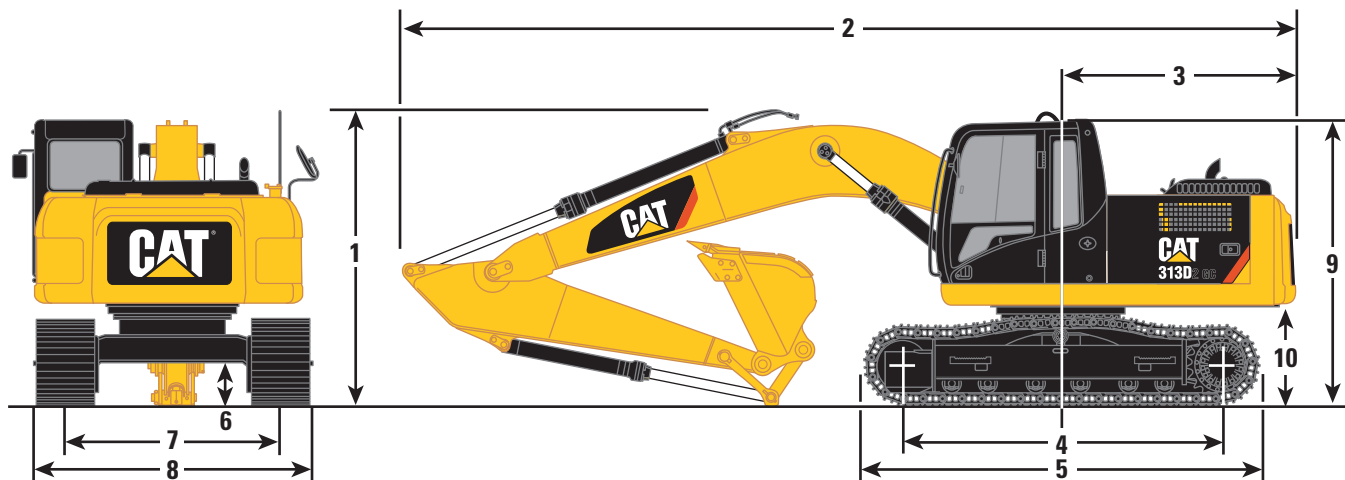

Boom Option

Reach Boom 4.65 m (15'3")

Stick Option

R2.5 (8'2")

R3.0 m (9'10")

	R2.5 (8'2")		R3.0 m (9'10")	
1 Shipping Height*	2830 mm	9'3"	2830 mm	9'3"
Shipping Height with Guard Rail	2830 mm	9'3"	2830 mm	9'3"
2 Shipping Length				
Standard Undercarriage	7610 mm	24'11"	7620 mm	25'0"
3 Tail Swing Radius	2140 mm	7'0"	2140 mm	7'0"
4 Length to Center of Rollers				
Standard Undercarriage	2780 mm	9'1"	2780 mm	9'1"
5 Track Length				
Standard Undercarriage	3490 mm	11'5"	3490 mm	11'5"
6 Ground Clearance**	430 mm	1'5"	430 mm	1'5"
7 Track Gauge	1990 mm	6'6"	1990 mm	6'6"
8 Transport Width				
500 mm (20") Shoes	2490 mm	8'2"	2490 mm	8'2"
770 mm (30") Shoes	2760 mm	9'1"	2760 mm	9'1"
9 Cab Height	2760 mm	9'1"	2760 mm	9'1"
10 Counterweight Clearance**	900 mm	3'0"	900 mm	2'11"

*Including shoe lug height.

**Without shoe lug height.

313D GC Series 2 Hydraulic Excavator Specifications

Working Ranges

All dimensions are approximate.

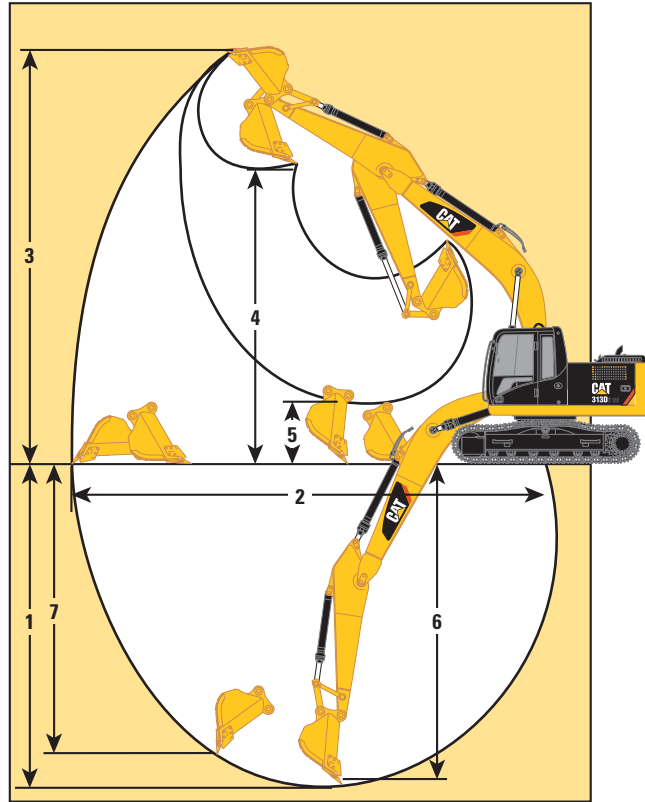

Boom Option	Reach Boom 4.65 m (15'3")			
	R2.5 (8'2")*		R3.0 m (9'10")**	
Stick Option				
1 Maximum Digging Depth	5540 mm	18'2"	6040 mm	19'10"
2 Maximum Reach at Ground Level	8180 mm	26'10"	8630 mm	28'4"
3 Maximum Cutting Height	8490 mm	27'10"	8710 mm	28'7"
4 Maximum Loading Height	6100 mm	20'0"	6330 mm	20'9"
5 Minimum Loading Height	2010 mm	6'7"	1530 mm	5'0"
6 Maximum Depth Cut for 2440 mm (8'0") Level Bottom	5340 mm	17'6"	5860 mm	19'3"
7 Maximum Vertical Wall Digging Depth	4610 mm	15'1"	4990 mm	16'4"

*The measurement is applicable on the machine equipped with the UD 0.53 m³ (0.69 yd³) bucket.

**The measurement is applicable on the machine equipped with the GD 0.65 m³ (0.85 yd³) bucket.

313D GC Series 2 Hydraulic Excavator Specifications

Operating Weight and Ground Pressure

Standard Undercarriage without Blade	500 mm (20") Triple Grouser Shoes				770 mm (30 in) Triple Grouser Shoes			
	kg	lb	kPa	psi	kg	lb	kPa	psi
Reach Boom – 4.65 m (15'3")								
R2.5 (8'2")*	12 500 kg	27,557.79 lb	40.4 kPa	5.86 psi	—	—	—	—
R2.5 m (8'2")**	12 600 kg	27,778 lb	40.7 kPa	5.90 psi	13 300 kg	29,321 lb	28.0 kPa	4.06 psi
R3.0 m (9'10")**	12 700 kg	27,998 lb	41.1 kPa	5.96 psi	13 400 kg	29,542 lb	28.2 kPa	4.09 psi

*Weight is rounded up to nearest 100 kg (220 lb) including UD 0.53 m³ (0.69 yd³) bucket.

**Weight is rounded up to nearest 100 kg (220 lb) including GD 0.65 m³ (0.85 yd³) bucket.

Major Component Weights

Base Machine (with boom cylinder, without counterweight, front linkage and track)	4490 kg	9,900 lb
Standard Undercarriage	2400 kg	5,300 lb
GC Counterweight – 2.1 mt (4,630 lb)	2100 kg	4,630 lb
Boom (includes lines, pins and stick cylinder)		
Reach Boom – 4.65 m (15'3")	1030 kg	2,270 lb
Stick (includes lines, pins and bucket cylinder)		
R2.5 m (8'2")	570 kg	1,260 lb
R3.0 m (9'10")	650 kg	1,430 lb
Track Shoe (Standard/per two tracks)		
500 mm (20 in) Triple Grouser	1460 kg	3,220 lb
770 mm (30 in) Triple Grouser	2230 kg	4,920 lb

All weights are rounded up to nearest 10 kg (22 lb) except for buckets. Kg and lb were rounded up separately so some of the kg and lb do not match.

Base machine includes 75 kg (165 lb) operator weight, 90% fuel weight, and undercarriage with center guard.

313D GC Series 2 Hydraulic Excavator Specifications

Bucket and Stick Forces

Boom Option	Reach Boom 4.65 m (15'3")			
Stick Options	R3.0 m (9'10")		R2.5 m (8'2")	
Utility Duty	0.65 m ³	0.85 yd ³	0.53 m ³	0.69 yd ³
Bucket Digging Force (ISO)	95 kN	21,400 lb	95 kN	21,400 lb
Stick Digging Force (ISO)	58 kN	13,100 lb	65 kN	14,700 lb
Bucket Digging Force (SAE)	85 kN	19,200 lb	85 kN	19,200 lb
Stick Digging Force (SAE)	57 kN	12,800 lb	64 kN	14,300 lb

Bucket Specifications and Compatibility – SE Asia, Brazil

	Width		Capacity		Weight		Fill	Reach Boom	Reach Boom
	mm	in	m ³	yd ³	kg	lb		R2.5 (8'2")	R3.0 (9'10")
Without Quick Coupler							%	500 mm (20") TG	500 mm (20") TG
General Duty (GD)	900	36	0.53	0.69	423	932	100	●	⊙
	1050	42	0.65	0.85	460	1,015	100	⊙	⊖
Maximum load pin-on (payload + bucket)							kg	1670	1475
							lb	3,681	3,250

The above loads are in compliance with hydraulic excavator standard EN474, they do not exceed 87% of hydraulic lifting capacity or 75% of tipping capacity with front linkage fully extended at ground line with bucket curled.

Capacity based on ISO 7451.

Bucket weight with long tips.

Maximum Material Density:

- 2100 kg/m³ (3,500 lb/yd³)
- ⊙ 1800 kg/m³ (3,000 lb/yd³)
- ⊖ 1500 kg/m³ (2,500 lb/yd³)

Caterpillar recommends using appropriate work tools to maximize the value customers receive from our products. Use of work tools, including buckets, which are outside of Caterpillar's recommendations or specifications for weight, dimensions, flows, pressures, etc. may result in less-than-optimal performance, including but not limited to reductions in production, stability, reliability, and component durability. Improper use of a work tool resulting in sweeping, prying, twisting and/or catching of heavy loads will reduce the life of the boom and stick.

313D GC Series 2 Hydraulic Excavator Specifications

Bucket Specifications and Compatibility – China

	Width		Capacity		Weight		Fill	Reach Boom
	mm	in	m ³	yd ³	kg	lb		R2.5 (8'2")
Without Quick Coupler								500 mm (20") TG
Utility Duty (UD)	900	36	0.53	0.69	411	906	100	●
General Duty (GD)	900	36	0.53	0.69	423	932	100	●
	1000	39	0.60	0.78	452	996	100	●
Maximum load pin-on (payload + bucket)							kg	1670
							lb	3,681

The above loads are in compliance with hydraulic excavator standard EN474, they do not exceed 87% of hydraulic lifting capacity or 75% of tipping capacity with front linkage fully extended at ground line with bucket curled.

Capacity based on ISO 7451.

Bucket weight with long tips.

Maximum Material Density:

- 2100 kg/m³ (3,500 lb/yd³)

Caterpillar recommends using appropriate work tools to maximize the value customers receive from our products. Use of work tools, including buckets, which are outside of Caterpillar's recommendations or specifications for weight, dimensions, flows, pressures, etc. may result in less-than-optimal performance, including but not limited to reductions in production, stability, reliability, and component durability. Improper use of a work tool resulting in sweeping, prying, twisting and/or catching of heavy loads will reduce the life of the boom and stick.

313D GC Series 2 Hydraulic Excavator Specifications

Bucket Specifications and Compatibility – All Cal

	Width		Capacity		Weight		Fill	Reach Boom	Reach Boom
	mm	in	m ³	yd ³	kg	lb		R2.5 (8'2")	R3.0 (9'10")
Without Quick Coupler								500 mm (20") TG	500 mm (20") TG
Utility Duty (UD)	900	36	0.53	0.69	411	906	100	2376	2007
General Duty (GD)	900	36	0.53	0.69	423	932	100	2353	1985
	1000	39	0.60	0.78	452	996	100	2030	1705
	1050	42	0.65	0.85	460	1,015	100	1862	1561
Maximum load pin-on (payload + bucket)									
							kg	1670	1475
							lb	3,681	3,250
With Quick Coupler									
Utility Duty (UD)	900	36	0.53	0.69	423	906	100	1881	1513
General Duty (GD)	900	36	0.53	0.69	423	932	100	1881	1513
	1000	39	0.60	0.78	452	996	100	1613	1288
	1050	42	0.65	0.85	460	1,015	100	1477	1177
Maximum load pin-on (payload + bucket)									
							kg	1420	1225
							lb	3,130	2,699

The above loads are in compliance with hydraulic excavator standard EN474, they do not exceed 87% of hydraulic lifting capacity or 75% of tipping capacity with front linkage fully extended at ground line with bucket curled.

Capacity based on ISO 7451.









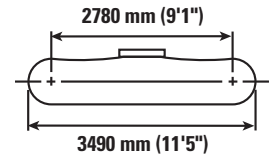
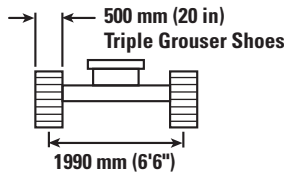
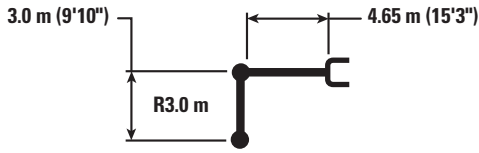



Bucket weight with long tips.

Caterpillar recommends using appropriate work tools to maximize the value customers receive from our products. Use of work tools, including buckets, which are outside of Caterpillar's recommendations or specifications for weight, dimensions, flows, pressures, etc. may result in less-than-optimal performance, including but not limited to reductions in production, stability, reliability, and component durability. Improper use of a work tool resulting in sweeping, prying, twisting and/or catching of heavy loads will reduce the life of the boom and stick.

313D GC Series 2 Hydraulic Excavator Specifications

Reach Boom Lift Capacities – Counterweight: 2.1 mt (4,630 lb) – without Bucket



		1.5 m/5.0 ft		3.0 m/10.0 ft		4.5 m/15.0 ft		6.0 m/20.0 ft		7.5 m/25.0 ft				
													m ft	
7.5 m 25.0 ft	kg lb											*2550	*2550	4.37
6.0 m 20.0 ft	kg lb											*2100	*2100	5.95
												*4,650	*4,650	19.52
4.5 m 15.0 ft	kg lb							3100 6,650	2250 4,800			*2000	1800	6.86
								6,650	4,800			*4,350	3,950	22.51
3.0 m 10.0 ft	kg lb					*3850 *8,400	3400 7,300	3050 6,500	2200 4,650			*2000	1550	7.36
								6,500	4,650			*4,350	3,400	24.15
1.5 m 5.0 ft	kg lb			*7550 *16,250	5750 12,350	4500 9,700	3150 6,750	2900 6,250	2050 4,450	2050	1450	2050	1450	7.52
												4,500	3,200	24.67
0 m 0 ft	kg lb			*7850 17,850	5300 11,350	4300 9,200	2950 6,300	2800 6,000	1950 4,200			2100	1450	7.38
												4,550	3,200	24.21
-1.5 m -5.0 ft	kg lb	*4500 *10,050	*4500 *10,050	8200 17,550	5150 11,100	4150 8,950	2850 6,100	2750 5,900	1900 4,100			2250	1600	6.91
												5,000	3,500	22.67
-3.0 m -10.0 ft	kg lb	*7500 *16,850	*7500 *16,850	8250 17,650	5200 11,200	4150 8,950	2850 6,100	2750	1950			2750	1950	6.04
												6,100	4,250	19.82
-4.5 m -15.0 ft	kg lb			*6450 *13,700	5450 11,650	*4050	3000					*4000	2950	4.53
												*8,800	6,700	14.86



ISO 10567



*Indicates that the load is limited by hydraulic lifting capacity rather than tipping load. The above loads are in compliance with hydraulic excavator lift capacity standard ISO 10567:2007. They do not exceed 87% of hydraulic lifting capacity or 75% of tipping load. Weight of all lifting accessories must be deducted from the above lifting capacities. Lifting capacities are based on the machine standing on a firm, uniform supporting surface. The use of a work tool attachment point to handle/lift objects, could affect the machine lift performance.

Lift capacity stays with ±5% for all available track shoes.

Always refer to the appropriate Operation and Maintenance Manual for specific product information.

313D GC Series 2 Hydraulic Excavator Specifications

Reach Boom Lift Capacities – Counterweight: 2.1 mt (4,630 lb) – without Bucket

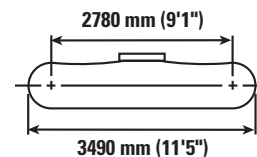
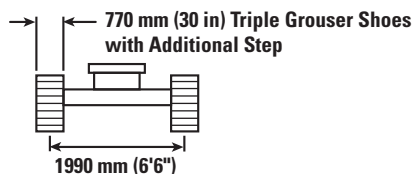
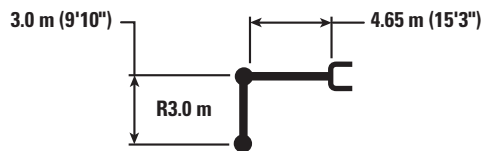

		1.5 m/5.0 ft		3.0 m/10.0 ft		4.5 m/15.0 ft		6.0 m/20.0 ft		7.5 m/25.0 ft		m ft		
7.5 m 25.0 ft	kg lb											*2550	*2550	4.37
6.0 m 20.0 ft	kg lb											*2100	*2100	5.95
												*4,650	*4,650	19.52
4.5 m 15.0 ft	kg lb							*3150	2350			*2000	1850	6.86
								*6,900	5,050			*4,350	4,150	22.51
3.0 m 10.0 ft	kg lb					*3850	3550	3150	2300			*2000	1650	7.36
						*8,400	7,650	6,800	4,900			*4,350	3,600	24.15
1.5 m 5.0 ft	kg lb			*7550	6000	4700	3300	3050	2150	*2150	1550	*2050	1550	7.52
				*16,250	12,900	10,150	7,100	6,550	4,650			*4,550	3,350	24.67
0 m 0 ft	kg lb			*7850	5550	4500	3100	2950	2050			2200	1550	7.38
				*18,150	11,900	9,650	6,650	6,300	4,450			4,800	3,400	24.21
-1.5 m -5.0 ft	kg lb	*4500	*4500	8600	5450	4400	3000	2900	2000			2400	1700	6.91
		*10,050	*10,050	18,400	11,650	9,400	6,400	6,200	4,300			5,250	3,650	22.67
-3.0 m -10.0 ft	kg lb	*7500	*7500	*8550	5500	4400	3000	2900	2050			2900	2050	6.04
		*16,850	*16,850	*18,500	11,750	9,400	6,400					6,400	4,500	19.82
-4.5 m -15.0 ft	kg lb			*6450	5700	*4050	3150					*4000	3100	4.53
				*13,700	12,200							*8,800	7,050	14.86



ISO 10567



*Indicates that the load is limited by hydraulic lifting capacity rather than tipping load. The above loads are in compliance with hydraulic excavator lift capacity standard ISO 10567:2007. They do not exceed 87% of hydraulic lifting capacity or 75% of tipping load. Weight of all lifting accessories must be deducted from the above lifting capacities. Lifting capacities are based on the machine standing on a firm, uniform supporting surface. The use of a work tool attachment point to handle/lift objects, could affect the machine lift performance.









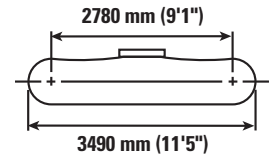
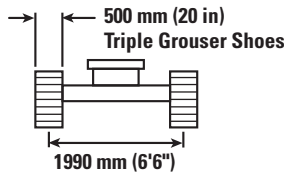
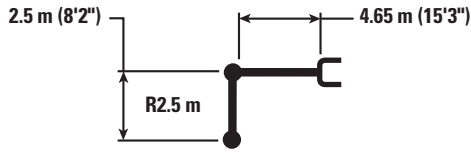

Lift capacity stays with ±5% for all available track shoes.

Always refer to the appropriate Operation and Maintenance Manual for specific product information.

313D GC Series 2 Hydraulic Excavator Specifications

Reach Boom Lift Capacities – Counterweight: 2.1 mt (4,630 lb) – without Bucket



		1.5 m/5.0 ft		3.0 m/10.0 ft		4.5 m/15.0 ft		6.0 m/20.0 ft				m ft
												
6.0 m 20.0 ft	kg lb					*3350 *7,450	*3350 *7,450			*2450 *5,400	*2450 *5,400	5.38 17.65
4.5 m 15.0 ft	kg lb					*3550 *7,750	3550 7,600	3100 6,600	2250 4,750	*2250 *4,950	2000 4,450	6.37 20.90
3.0 m 10.0 ft	kg lb			*5850 *12,500	*5850 *12,500	*4350 *9,400	3350 7,200	3000 6,450	2150 4,650	*2250 *4,900	1750 3,800	6.90 22.64
1.5 m 5.0 ft	kg lb			*8450 *18,100	5600 12,050	4500 9,600	3150 6,700	2900 6,250	2100 4,450	2300 5,000	1600 3,550	7.08 23.23
0 m 0 ft	kg lb			*6900 *15,900	5300 11,400	4300 9,200	2950 6,350	2850 6,050	2000 4,300	2300 5,050	1650 3,600	6.93 22.74
-1.5 m -5.0 ft	kg lb	*4850 *10,900	*4850 *10,900	8300 17,750	5250 11,300	4200 9,050	2900 6,200	2800 6,000	1950 4,200	2550 5,600	1800 3,950	6.43 21.10
-3.0 m -10.0 ft	kg lb	*8750 *19,750	*8750 *19,750	*8100 *17,400	5350 11,500	4250 9,150	2950 6,300			3250 7,200	2250 5,050	5.48 17.98



ISO 10567



*Indicates that the load is limited by hydraulic lifting capacity rather than tipping load. The above loads are in compliance with hydraulic excavator lift capacity standard ISO 10567:2007. They do not exceed 87% of hydraulic lifting capacity or 75% of tipping load. Weight of all lifting accessories must be deducted from the above lifting capacities. Lifting capacities are based on the machine standing on a firm, uniform supporting surface. The use of a work tool attachment point to handle/lift objects, could affect the machine lift performance.









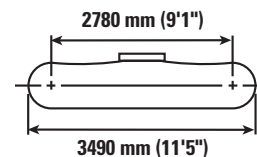
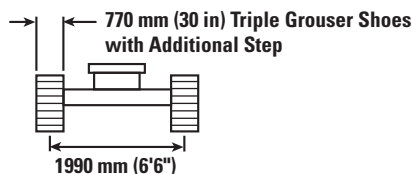
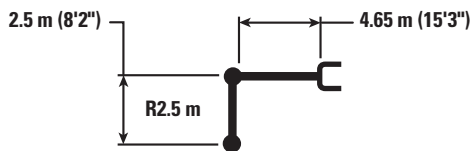

Lift capacity stays with ±5% for all available track shoes.

Always refer to the appropriate Operation and Maintenance Manual for specific product information.

313D GC Series 2 Hydraulic Excavator Specifications

Reach Boom Lift Capacities – Counterweight: 2.1 mt (4,630 lb) – without Bucket



		1.5 m/5.0 ft		3.0 m/10.0 ft		4.5 m/15.0 ft		6.0 m/20.0 ft				m ft
												
6.0 m 20.0 ft	kg lb					*3350 *7,450	*3350 *7,450			*2450 *5,400	*2450 *5,400	5.38 17.65
4.5 m 15.0 ft	kg lb					*3550 *7,750	*3550 *7,750	3200 6,900	2350 5,000	*2250 *4,950	2100 4,650	6.37 20.90
3.0 m 10.0 ft	kg lb			*5850 *12,500	*5850 *12,500	*4350 *9,400	3500 7,550	3150 6,750	2250 4,850	*2250 *4,900	1800 4,000	6.90 22.64
1.5 m 5.0 ft	kg lb			*8450 *18,100	5850 12,600	4700 10,050	3250 7,050	3050 6,550	2200 4,650	*2350 *5,100	1700 3,750	7.08 23.23
0 m 0 ft	kg lb			*6900 *15,900	5550 11,950	4500 9,650	3100 6,650	2950 6,350	2100 4,500	2450 5,350	1700 3,750	6.93 22.74
-1.5 m -5.0 ft	kg lb	*4850 *10,900	*4850 *10,900	8700 18,600	5500 11,850	4450 9,500	3050 6,500	2950 6,300	2050 4,450	2700 5,900	1900 4,150	6.43 21.10
-3.0 m -10.0 ft	kg lb	*8750 *19,750	*8750 *19,750	*8100 *17,400	5600 12,050	4450 9,600	3050 6,600			3400 7,550	2400 5,300	5.48 17.98



ISO 10567



*Indicates that the load is limited by hydraulic lifting capacity rather than tipping load. The above loads are in compliance with hydraulic excavator lift capacity standard ISO 10567:2007. They do not exceed 87% of hydraulic lifting capacity or 75% of tipping load. Weight of all lifting accessories must be deducted from the above lifting capacities. Lifting capacities are based on the machine standing on a firm, uniform supporting surface. The use of a work tool attachment point to handle/lift objects, could affect the machine lift performance.

Lift capacity stays with ±5% for all available track shoes.

Always refer to the appropriate Operation and Maintenance Manual for specific product information.

313D GC Series 2 Standard Equipment

Standard Equipment

Standard equipment may vary. Consult your Cat dealer for details.

ENGINE

- Diesel engine – Cat C4.4 with mechanical governor
 - 2300 m (7,546 ft) altitude capability
 - 50 amp alternator, air intake heater
 - Tier 3/Stage IIIA equivalent and China Nonroad Stage III emission standards
- 10 micron fuel filter
- 4 micron fuel pre-filter
- One touch low idle with AEC
- Remote engine oil filter
- Radial seal air filter, double element
- Two speed travel
- Water separator in fuel line with indicator
- Waved fin radiator with side by side type oil cooler
- Fix type A/C condenser
- 46 (49 at partial engine control)

CAB

- Bolt-on FOGS capability
- Openable front windshield with assist device
- Pillar mounted upper windshield wiper and washer
- Front windshield glass split by 70/30
- Cab sliding upper door window
- Rear window, emergency exit
- Removable lower windshield with in cab storage bracket
- Metal hatch
- Interior lighting
- Standard joystick
- Laminated front upper windshield
- Seat high back, mechanical suspension with head rest
- Seat belt, retractable
- Floor mat
- Bi-level air conditioner (auto) with defroster
- Windshield washer
- Coat hook

- Ashtray and lighter
- Beverage holder
- Literature holder
- Radio mounting
- Mounting for two stereo speakers
- Antenna flexible type
- Storage compartment suitable for lunch box
- Monitor
 - Language display
 - Full graphic and full color display
 - Warning information
 - Filter/fluid change information
 - Machine condition
 - Error code and tool mode setting information
 - Full time clock on monitor
- Positive filtered ventilation
- Seat integrated control joystick
- Adjustable armrest
- Adjustable console
- Neutral lever (lock out) for all controls
- Travel control pedals with removable hand levers
- Capability of installing two additional pedals

ELECTRICAL

- Circuit breaker
- Cat battery

COUNTERWEIGHT

- Counterweight without lifting eye (2100 kg/4,630 lb)

FRONT LINKAGE

- Boom, 4.65 m (15'3")
- Bucket linkage

TECHNOLOGY

- Product Link™

HYDRAULIC

- Hydraulic main pump
- High performance hydraulic return filter
- Regeneration control for boom and stick
- Boom lowering device for back up
- Boom drift reducing valve
- Stick drift reducing valve
- Reverse swing damping valve
- Automatic swing parking brake
- Auxiliary hydraulic valve
- Capability of stackable valves for main valve
- Capability of auxiliary circuit

SECURITY

- Cat one key security system
- Signaling/warning horn
- Mirrors, rearview (frame – right, cab – left)
- Secondary engine shutoff switch
- Door locks
- Cap locks on fuel and hydraulic tanks
- Lockable external tool/storage box
- Openable skylight for emergency exit
- Rearview camera-ready

LIGHTS

- Halogen boom light (left side)
- Exterior lights integrated into storage box

UNDERCARRIAGE

- Grease lubricated track (GLT2)
- Idler section track guiding guard
- Towing eye on base frame
- Standard idler tension spring
- Guard, standard bottom
- 500 mm (20") triple grouser shoes
- 770 mm (31") triple grouser shoes

For more complete information on Cat products, dealer services, and industry solutions, visit us on the web at www.cat.com

© 2017 Caterpillar
All rights reserved

Materials and specifications are subject to change without notice. Featured machines in photos may include additional equipment. See your Cat dealer for available options.

CAT, CATERPILLAR, SAFETY.CAT.COM, their respective logos, "Caterpillar Yellow" and the "Power Edge" trade dress, as well as corporate and product identity used herein, are trademarks of Caterpillar and may not be used without permission.

AEHQ7893-02
Replaces AEHQ7893-01
(GN1, India, Indonesia,
LACD, Southeast Asia)

