

320F L

Hydraulic Excavator



Engine

Engine Model	Cat® C4.4 ACERT™
Engine Power – ISO 14396	122 kW (166 PS)
Net Power – ISO 9249	120 kW (163 PS)

Drive

Maximum Travel Speed – High	5.6 km/h
Maximum Drawbar Pull	205 kN

Weights

Minimum Operating Weight	21 500 kg
Maximum Operating Weight	23 000 kg

If you are looking for a reliable, durable, low-cost-per-hour excavator to get your work done – backed by unmatched support from a brand you can trust – look no further than the 320F L. It simply makes a great deal of business sense.

The new Cat 320FL is built for those who need strong, reliable performance at a low cost per hour.

The machine features an efficient C4.4 ACERT engine that's light on fuel. It also has a proven hydraulic system that will help you take on a variety of tasks.

Unlike other brands in its size class, the machine comes equipped with more unique attributes: Robust structures, strong and stable undercarriage, a quiet and comfortable roll-over protective structure (ROPS) cab, and easy-to-reach service points are just a few.

Contents

Reliable and Productive.....	4
Fuel Efficient.....	6
Integrated Technologies.....	7
Easy to Operate.....	8
Durable Linkages.....	10
Structures & Undercarriage.....	11
Attachments.....	12
Serviceable.....	14
Safe Work Environment.....	16
Complete Customer Care.....	17
Sustainability.....	18
Specifications.....	19
Standard Equipment.....	30
Optional Equipment.....	31





Reliable and Productive

Power to move your material with speed, ease, and precision

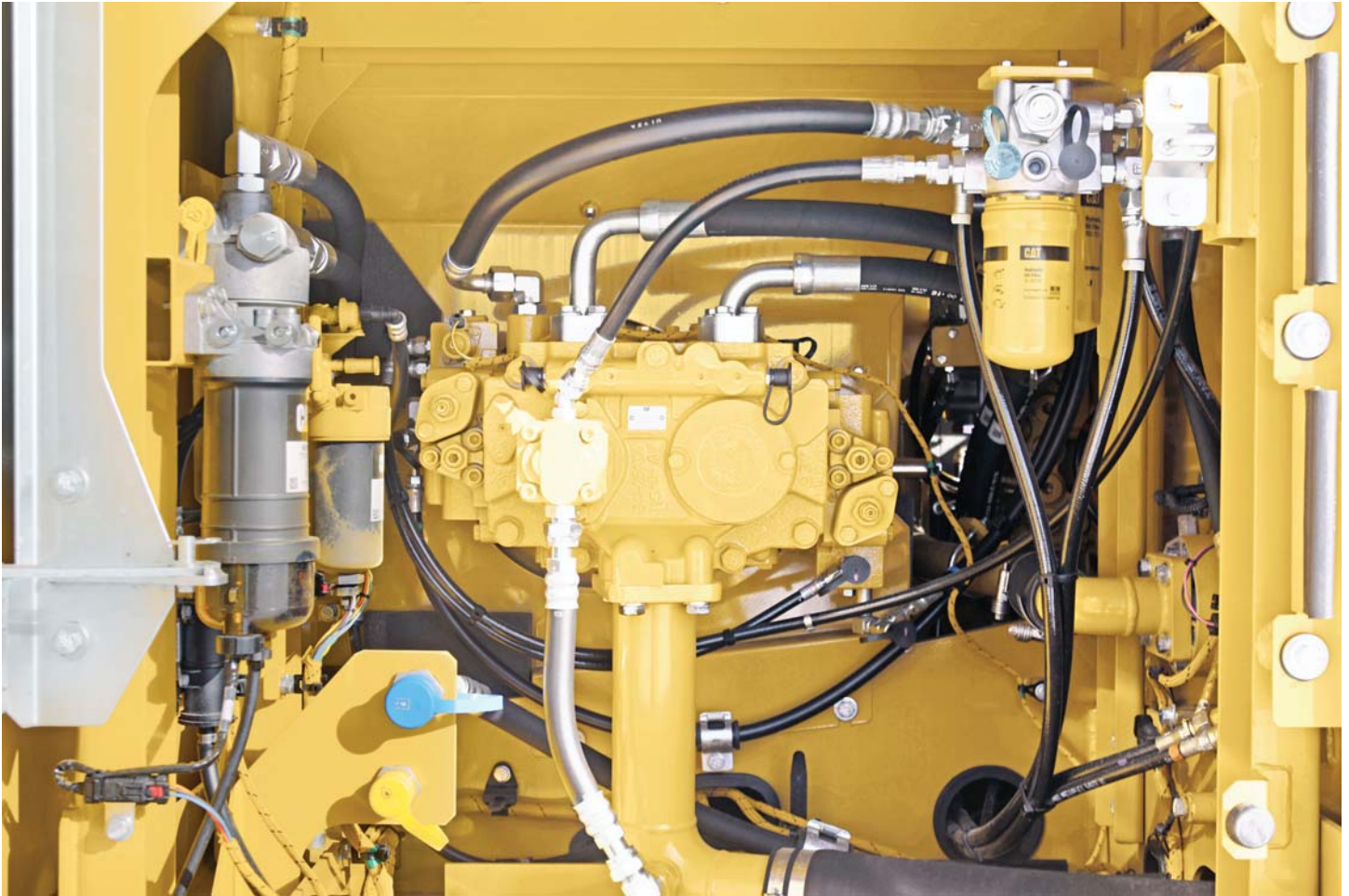

A Logical Layout

All major hydraulic components are strategically located close together. This positioning leads to reduced friction loss and pressure drops, and the result is more hydraulic horsepower for the heavy-lifting, ground-breaking work you need to get done.

A Forceful, Responsive Design

The 320F L features a negative flow control hydraulic system. In layman's terms, negative flow control *decreases* pump flow when oil pressure *increases* and vice versa. The net result is the pump and valve operate in harmony with less energy *and* less wear and tear.

Valves For Added Efficiency

The 320F L is built with a back-to-back main control valve, and the benefit to you is reduced pressure loss and fuel consumption due to the shorter distance oil has to travel. The machine also features special boom and stick valves that recirculate oil flow in the cylinders during work instead of going all the way back to the tank. The valves contribute to energy savings, but their primary benefit is allowing more oil to flow to other functions so you can experience faster cycle times and more production.

Tool Control For Enhanced Performance

Tool control is a distinct Cat excavator advantage that adds incredible convenience and enhanced performance to your everyday work. The electronic system stores flows and pressures for up to 20 work tools right in the cab monitor, eliminating the need to calibrate tools every time you make a change out front. It works with both one- and two-way-flow tools, and it can be outfitted with a third pump and medium-pressure circuit so you can use tools like shears, grapples, and tilt buckets. Standard high-pressure circuits make the tools open and close; medium-pressure circuits enable them to rotate. Adding an optional quick coupler circuit makes tool changes even faster for maximum productivity.



Other Cat Exclusive Hydraulic System Advantages



The capsule filter (1) is designed to take out impurities and help you avoid system contamination and accidental spilling. The self-contained, maintenance-friendly filter is easy to remove with a simple wrench. It can take out impurities as small as beta 10 – particles so tiny you cannot see them with the eye. A sensor lets you know if there is a clog or if pressure exceeds a certain level so you can take action.

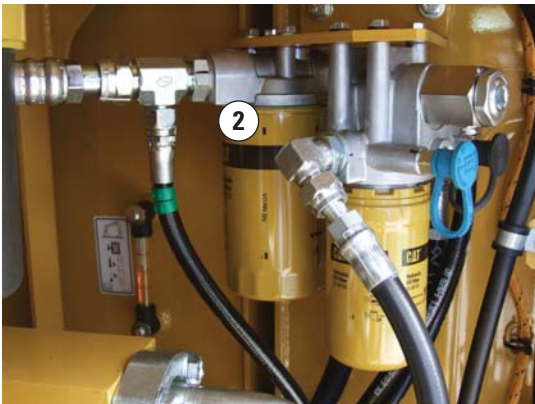

The drain filter (2) is one extra level of contamination prevention Cat excavators offer. Located in the pump compartment behind the pilot filter, the drain filter purifies the case drain from the main pumps, swing motor, and travel motors – all to enhance the life of the pumps and motors and increase uptime for you.

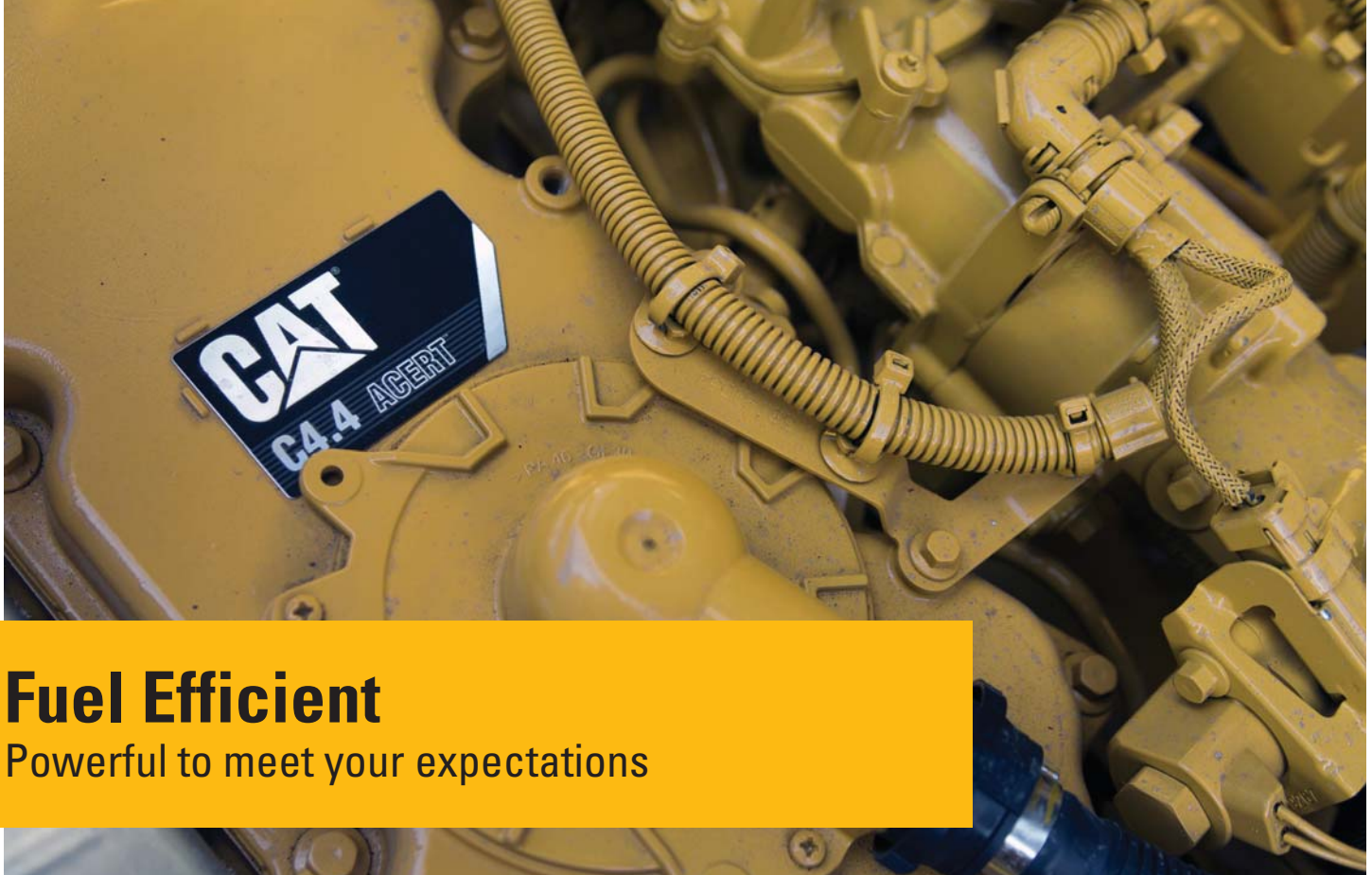

Fuel Efficient

Powerful to meet your expectations

Proven Technology

Every EU Stage IV ACERT engine is equipped with a combination of proven electronic, fuel, air, and aftertreatment components. Applying these time-tested technologies lets us meet your high expectations for productivity, fuel efficiency, reliability, and service life.

Following are the results you can expect:

- **Improved fluid efficiency of up to 5%** over Stage IIIB products, including Diesel Exhaust Fluid (DEF) consumption.
- **High performance** across a variety of applications.
- **Enhanced reliability** through commonality and simplicity of design.
- **Maximized uptime and reduced cost** with world-class Cat dealer support.
- **Minimized impact** on emission systems – with no operator interaction required.
- **Durability** with long service life.
- **Better fuel economy** with minimized maintenance costs.
- **Same great power** and response.

Less Fuel, Same Power

The 320F L consumes up to 8% less fuel than a same-size Stage IIIB machine with no loss in power. How's that possible? Simple. Advanced engine technology and system control. Isochronous control, for example, permits the engine to run at a constant lower speed but at an optimum point in the power curve for maximum efficiency. Automatic engine speed control also contributes by lowering rpm when the machine isn't calling for it. Plus you have a choice of two power modes – standard and eco mode. Simply change between modes through the switch panel to meet the work needs in front of you. Collectively, all of these benefits add up to reduced fuel consumption, reduced repair and maintenance costs, and increased engine life for you.

Biodiesel Not A Problem

The C4.4 ACERT engine can run on up to B20 biodiesel that meets ASTM 6751 standards – all to give you more potential fuel-saving flexibility.

Integrated Technologies

Monitor, manage, and enhance your
job site operations



Cat Connect

The smart use of technology and services will improve your job site efficiency. In fact, using data from technology-equipped machines give you more information and insight into your equipment and operations than ever before.

LINK Technologies

LINK technologies like Product Link™ wirelessly connect you to your equipment, giving you valuable insight into how your machine or fleet is performing. The system comes as standard equipment on the 320F, and it tracks location, hours, fuel usage, productivity, idle time, and diagnostic codes through the online VisionLink® interface so you can make timely, fact-based decisions to maximize efficiency, improve productivity, and lower operating costs.





Easy to Operate

Comfort and convenience to keep you productive

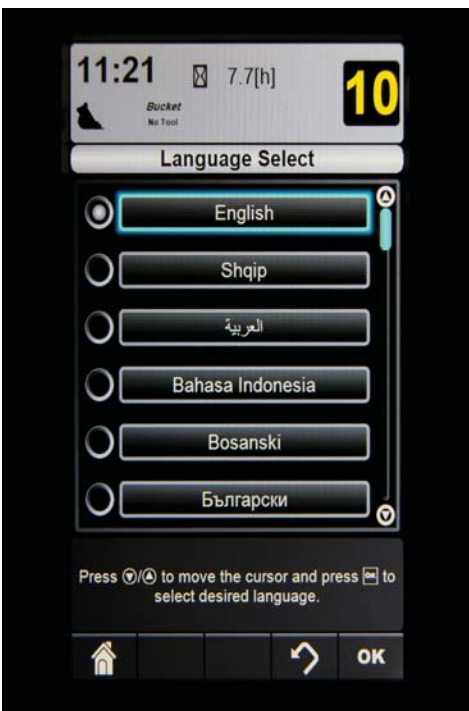

A Helpful Monitor

The LCD monitor is easy to see and navigate. Programmable in up to 44 languages to meet today's diverse workforce, the monitor clearly displays critical information you need to operate efficiently and effectively. Plus it projects the image from the standard rearview camera to help you see what's going on around you so you can stay safely focused on the job at hand.

A Safe, Quiet Cab

The ROPS cab provides you with a safe working environment when properly seated and belted. It also contributes to your comfort because it's attached to a reinforced frame with special viscous mounts that limit vibration and unnecessary sound. Add in special roof lining and sealing and you have a cab that's as quiet inside as today's top pickup trucks.



Comfortable Seat

An air suspension seat comes standard on the 320F. The seat features a reclining back, upper and lower slide adjustments, and height and tilt angle adjustments to meet your needs for maximum comfort.



A Cool & Warm Environment

The automatic climate control system features multiple air outlets with filtered ventilation. Air flows on the floor, behind the seat, and in front of you to make your work in either hot or cold weather much more pleasant and productive.



Controls Just For You

The joystick consoles adjust to improve your comfort and productivity during the course of a day. The armrests telescope up and down just like a bicycle seat. Joysticks for tool control have buttons to make working with a two-way-flow grapple, thumb, and shear simple. The right joystick features a button that will reduce engine speed when you are not working to help save fuel. Touch it once and speed reduces; touch it again and speed increases for normal operation.



Ample Storage & Auxiliary Power

Storage spaces are located in the front, rear, and side consoles of the cab. A drink holder accommodates a large mug, and a shelf behind the seat stores large lunch or toolboxes. Two 12-volt power supply sockets are conveniently located near the key storage areas for charging your electronic devices like an MP3 player, a cell phone, or a tablet.

Durable Linkages

Options to take on your far-reaching and up-close tasks



Link & Pins

The power link between the stick and bucket is designed for long-term heavy-duty lifting. With an integrated lifting eye, the power link helps enhance the machine's lifting capability by lowering your load point and maximizing the power built into the boom cylinders. All pins used in the front linkage have thick chrome plating to give them high wear and corrosion resistance. The large diameter pins distribute load weight to ensure long pin, boom, and stick life.

Boom & Stick

The 320F is offered with a Reach or Variable Angle boom and 2.9 m stick. This combination allows for excellent all-around versatility. Your Cat dealer can help you equip the machine with the right attachments for your specific line of work.

Built To Last

The boom and stick are built with internal baffle plates for additional durability, and they undergo ultrasound inspection to ensure quality and reliability. Large box-section structures with thick, multi-plate fabrications, castings, and forgings are used in high-stress areas such as the boom nose, boom foot, and boom and stick cylinders to enhance durability for the tough work you do.

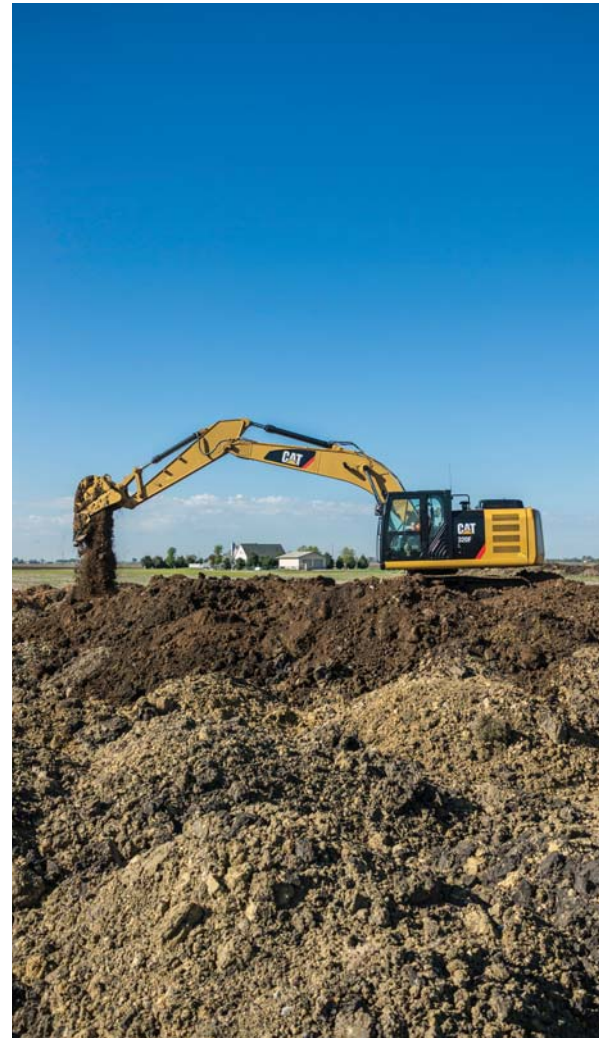



Structures & Undercarriage

Made to work in your demanding applications



Robust Frame

The 320F L is a well-built machine designed to give you a very long service life. The upper frame (1) has mountings made specifically to support the heavy-duty cab; it's also reinforced around key areas that take on stress like the boom foot and skirt. Massive bolts are used to attach the track frames to the body, and additional bolts are used throughout to increase the machine's digging force, which leads to more productivity for you.



Durable Undercarriage

The long undercarriage (2) contributes significantly to the 320F's outstanding stability and durability. Track shoes, links, rollers, idlers, and final drives are all built with long-lasting, high-tensile-strength steel. Cat Grease Lubricated Track 2 (GLT2) track link protects moving parts by keeping water, debris, and dust out and grease sealed in, which delivers longer wear life and reduced noise when traveling. Optional guide guards help maintain track alignment to improve the machine's overall performance – whether you're traveling on a flat, heavy bed of rock or a steep, wet field of mud.



Huge Counterweight

The heavier counterweight (3) weighs nearly 3700 kg to help enhance lift capability – out front and over the side. Rounded to minimize the amount of overhang, the weight is bolted directly to the main frame using four massive bolts to ensure maximum rigidity. Plus the counterweight has an integrated housing to help protect the machine's standard rearview camera.

Attachments

Tools to make you productive and profitable



Get The Most Out Of One Machine

You can easily expand the performance of your machine by utilizing any of the variety of attachments offered by Cat Work Tools.

Change Jobs Quickly

A quick coupler brings the ability to quickly change attachments and switch from job to job. The Cat Pin Grabber coupler is the secure way to decrease downtime and increase job site flexibility and overall productivity.

Dig, Rip, Finish & Compact

Cat buckets dig everything from top soil to harsh, abrasive material. Add a ripper to get through hard rock. For finishing and grading work, compact and shallow ditch cleaning buckets fit the need. A Cat compactor prepares the area for the next phase of construction.

Break, Demolish, Scrap, Move & Handle

A hydraulic hammer equips your machine for breaking rock in quarries, preparing trenches on construction sites, or taking down bridge pillars and reinforced concrete on road jobs. Multi-processor, pulverizer, and shear attachments take your machine into structure demolition jobs and process the debris for reuse and recycle. Add a thumb to move and handle brush, rocks, and debris. For constant material handling, a grapple is your solution. Choose from three different styles for picking, sorting, and loading trash, demolition debris, or recyclables.

Set Up Your Machine For Profitability

Your Cat dealer can install hydraulic kits to properly operate all Cat Work Tool attachments – maximizing the machine's uptime and your profits. All Cat Work Tool attachments are supported by the same Cat dealer network as your Cat machine.



1) CW dedicated Quick Coupler 2) General Duty (GD)
3) Heavy Duty (HD) 4) Severe Duty (SD) 5) Extreme Duty (XD)



Serviceable

Designed to make your maintenance quick and easy



On-Board Monitoring

The 320F has a pre-start monitoring system that allows you to check coolant, hydraulic oil, and engine oil levels right inside the cab. The monitor also tells you fluid and filter change intervals to ensure you keep the machine in top-performing condition.

Safe, Convenient Access

You can see the service hour meter inside the cab and reach most routine maintenance items like fluid taps and grease points from the safety and convenience of ground level. Filters are banked together for higher service efficiency. Compartments feature wide service doors and heavy-duty hardware to keep them open – all to make service work simpler and more secure.

A Fresh Idea

The fresh air filter is conveniently located on the side of the cab to make it easy for you to reach and replace. It's protected by a lockable door that can only be opened with the engine key.

A Priming Solution

Located in the pump compartment, an electric fuel priming pump eliminates the need for you to manually prime after filter changes. It also eliminates the risk of fuel contamination by preventing unfiltered fuel from being backfilled during filter changes.

More Service Benefits

Drain tubes beneath the machine make it easy and simple for you to remove water and sediment during routine maintenance. They also make it easy to change oil without special tools or the risk of spilling. Same goes for an integrated fuel level indicator that pops up to help you reduce the possibility of fuel tank overfilling.

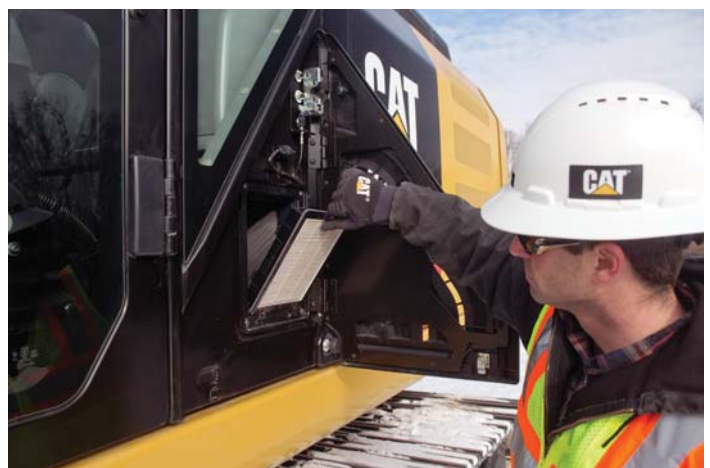

Safe Work Environment

Features to help protect you day in and day out

A Safe, Quiet Cab

The ROPS cab provides you with a safe working environment when properly seated and belted. It also contributes to your comfort because it's attached to a reinforced frame with special viscous mounts that limit vibration and unnecessary sound. Add in special roof lining and sealing and you have a cab that's as quiet inside as any of today's top pickup trucks.

Secure Contact Points

Multiple large steps get you into the cab as well as a leg up to the compartments. Extended hand and guard rails allow you to safely climb to the upper deck. Anti-skid plates reduce your slipping hazards in all types of weather conditions, and they can be removed for cleaning.

Great Views

Ample glass gives you excellent visibility out front and to the side, and the available rearview camera gives you a clear field of view behind the machine through the cab monitor. The available split-configuration windshield features an upper window with handles that make it easy to slide and store above you and a lower window that can be removed and stored on the inside wall of the cab. The large skylight also serves as an emergency exit and provides you with enhanced overhead visibility.

Smart Lighting

Halogen lights provide plenty of illumination, and the cab and boom lights can be programmed to stay on for up to 90 seconds after the engine has been turned off to help you safely exit the machine.

Guard Options

The 320F can be equipped with several guarding options. Following are just a few offered by your local Cat dealer that will help protect you and your machine:

- Falling Object Guarding System (FOGS)
- Vandal guards
- Swivel guard

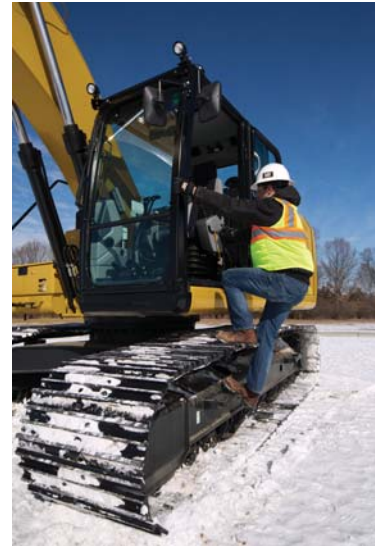



Complete Customer Care

Support you can count on

Expert Advice You Can Trust

What are the job requirements and machine attachments? What production is needed? Your Cat dealer can provide recommendations to help you make the right machine choices.

Support Agreements To Fit Your Needs

Cat dealers offer a variety of customer support agreements and work with you to develop a plan to meet your specific needs. These plans can cover the entire machine, including attachments, to help protect your investment.

Parts When And Where You Need Them

Cat dealers utilize a worldwide parts network to maximize your machines' uptime. Plus they can help you save money with Cat remanufactured components.

Operating Techniques To Boost Your Profits

Improving operating techniques can boost your profits. Your Cat dealer has videos, literature, and other ideas to help you increase productivity. Caterpillar also offers simulators and certified operator training to help maximize the return on your investment.

Financial Options Just For You

Consider financing options and day-to-day operating costs. Look at dealer services that can be included in the machine's cost to yield lower owning and operating costs over time.

What's Best For You Today...And Tomorrow

Repair, rebuild, or replace? Your Cat dealer can help you evaluate the cost involved so you can make the best choice for your business.



Sustainability

Generations ahead in every way

- The C4.4 ACERT engine is miserly on fuel and meets Stage IV emission standards.
- The engine can run on either ultra-low-sulfur diesel (ULSD) fuel with 10 ppm of sulfur or less or biodiesel (up to B20) fuel blended with ULSD.
- A ground-level overfill indicator rises when the tank is full to help the operator avoid spilling.
- The machine is built to be rebuilt with major structures and components capable of being remanufactured to reduce waste and replacement costs.
- The 320F L is an efficient, productive machine that's designed to conserve our natural resources for generations ahead.

320F L Hydraulic Excavator Specifications

Engine

Engine Model	Cat C4.4 ACERT
Engine Power – ISO 14396	122 kW (166 PS)
Net Power – ISO 9249	120 kW (163 PS)
Bore	105 mm
Stroke	127 mm
Displacement	4.4 L

- The 320F meets Stage IV emission standards.
- No engine power derating required below 3000 m altitude.
- Rating at 1,800 rpm.

Track

Number of Shoes Each Side	49 pieces
Number of Track Rollers Each Side	8 pieces
Number of Carrier Rollers Each Side	2 pieces

Swing Mechanism

Swing Speed	11.2 rpm
Swing Torque	61.8 kN·m

Drive

Maximum Travel Speed – High	5.6 km/h
Maximum Drawbar Pull	205 kN

Hydraulic System

Main System – Maximum Flow (Total)	428 L/min
Maximum Pressure – Equipment	
Heavy Lift	38 000 kPa
Normal	35 000 kPa
Maximum Pressure – Travel	35 000 kPa
Maximum Pressure – Swing	25 000 kPa
Pilot System – Maximum Flow (Total)	24.3 L/min
Pilot System – Maximum Pressure	3920 kPa
Boom Cylinder – Bore	120 mm
Boom Cylinder – Stroke	1260 mm
Stick Cylinder – Bore	140 mm
Stick Cylinder – Stroke	1504 mm
Bucket Cylinder – Bore	120 mm
Bucket Cylinder – Stroke	1104 mm

Service Refill Capacities

Fuel Tank Capacity	410 L
DEF Tank Capacity	21 L
Cooling System	30 L
Engine Oil	25 L
Swing Drive	8 L
Final Drive	8 L
Hydraulic System Oil (including tank)	260 L
Hydraulic Tank Oil	159 L

Sound Performance

Exterior Sound Power Level – ISO 6395	97 dB(A)
Operator Sound Pressure Level – ISO 6396	68 dB(A)

- When properly installed and maintained, the cab offered by Caterpillar, when tested with doors and windows closed according to ANSI/SAE J1166 OCT98, meets OSHA and MSHA requirements for operator sound exposure limits in effect at time of manufacture.
- Hearing protection may be needed when operating with an open operator station and cab (when not properly maintained or doors/windows open) for extended periods or in a noisy environment.

320F L Hydraulic Excavator Specifications

Dimensions

All dimensions are approximate.

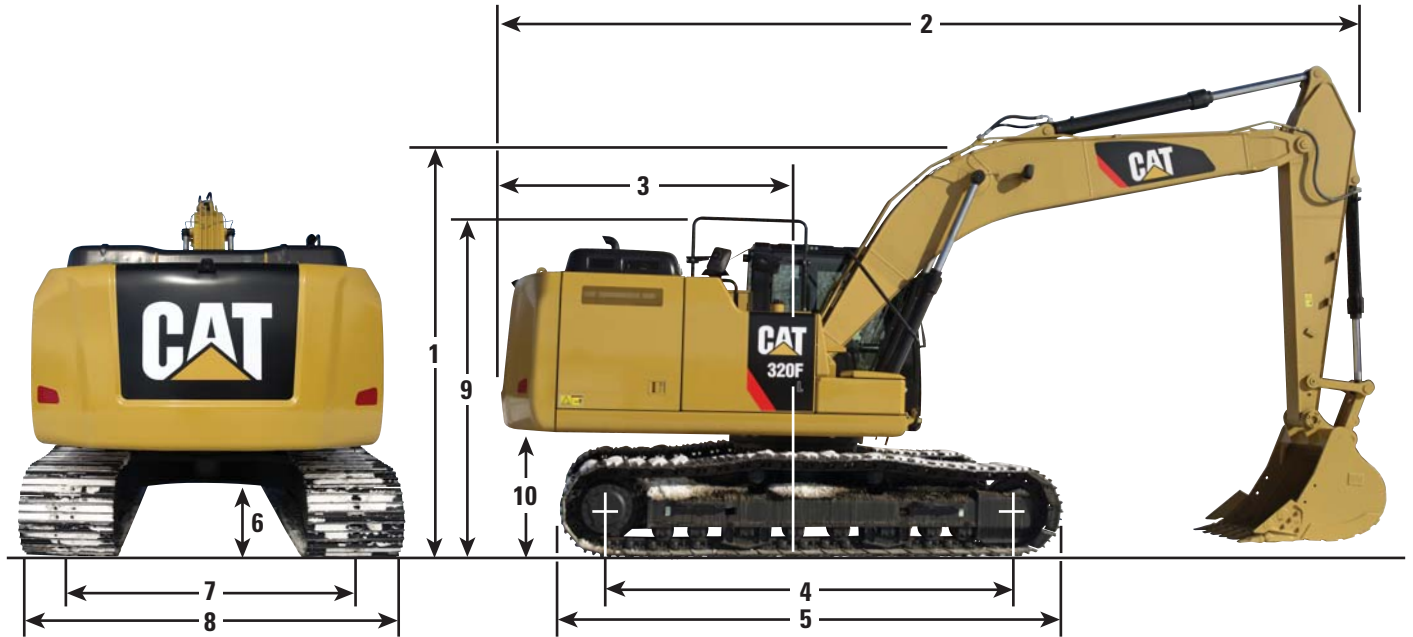

Boom Options Stick Options	Reach Boom – 5.7 m		Variable Angle Boom	
	R2.9 m	R2.5 m	R2.9 m	R2.5 m
1 Shipping Height	3130 mm	3050 mm	3010 mm	3020 mm
2 Shipping Length	9540 mm	9450 mm	9780 mm	9820 mm
3 Tail Swing Radius	2830 mm	2830 mm	2830 mm	2830 mm
4 Length to Center of Rollers – Long Undercarriage	3650 mm	3650 mm	3650 mm	3650 mm
5 Track Length – Long Undercarriage	4460 mm	4460 mm	4460 mm	4460 mm
6 Ground Clearance	450 mm	450 mm	450 mm	450 mm
7 Track Gauge – Long Undercarriage (shipping)	2380 mm	2380 mm	2380 mm	2380 mm
8 Transport Width – Long Undercarriage				
600 mm Shoes	2980 mm	2980 mm	2980 mm	2980 mm
700 mm Shoes	3080 mm	3080 mm	3080 mm	3080 mm
790 mm Shoes	3170 mm	3170 mm	3170 mm	3170 mm
9 Handrail Height	3010 mm	3010 mm	3010 mm	3010 mm
10 Counterweight Clearance	1020 mm	1020 mm	1020 mm	1020 mm
Bucket Type	HD	GD	GD	GD
Bucket Capacity	1.19 m ³	1.3 m ³	1.3 m ³	1.3 m ³

320F L Hydraulic Excavator Specifications

Working Ranges

All dimensions are approximate.

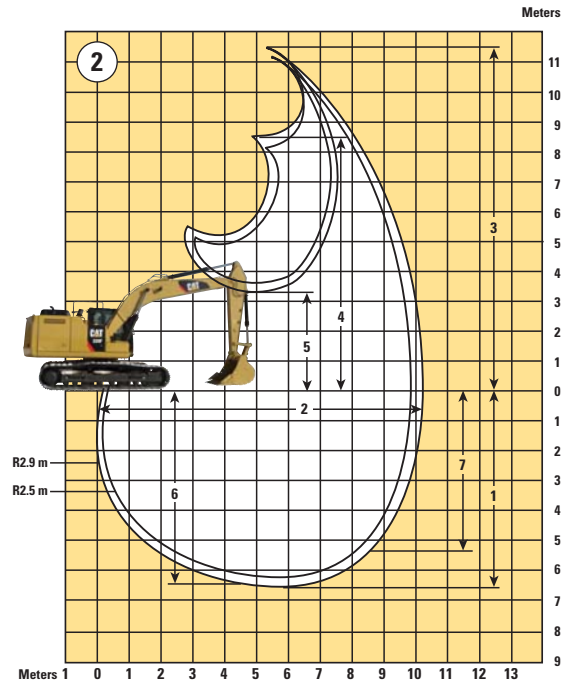
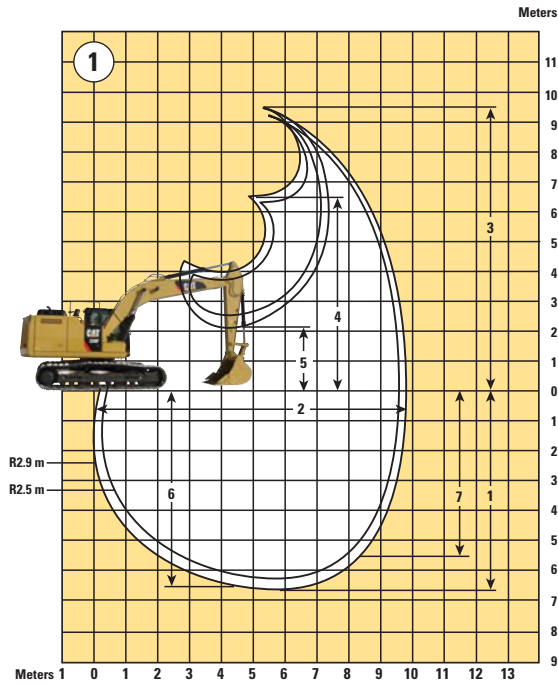

Boom Options

Reach Boom 5.7 m

Variable Angle Boom

①

②

Stick Options

	R2.9 m	R2.5 m	R2.9 m	R2.5 m
1 Maximum Digging Depth	6710 mm	6290 mm	6680 mm	6270 mm
2 Maximum Reach at Ground Line	9850 mm	9450 mm	10 200 mm	9800 mm
3 Maximum Cutting Height	9450 mm	9240 mm	11 520 mm	11 180 mm
4 Maximum Loading Height	6500 mm	6300 mm	8410 mm	8070 mm
5 Minimum Loading Height	2180 mm	2600 mm	3270 mm	3670 mm
6 Maximum Depth Cut for 2440 mm Level Bottom	6540 mm	6100 mm	6580 mm	6170 mm
7 Maximum Vertical Wall Digging Depth	5610 mm	5210 mm	5290 mm	4890 mm
Bucket Type	GD	GD	GD	GD
Bucket Capacity	1.3 m ³	1.3 m ³	1.3 m ³	1.3 m ³
Bucket Digging Force (ISO)	140 kN	140 kN	140 kN	140 kN
Stick Digging Force (ISO)	107 kN	118 kN	107 kN	118 kN

320F L Hydraulic Excavator Specifications

Operating Weights and Ground Pressures

Long Undercarriage			600 mm Shoes		700 mm Shoes		790 mm Shoes	
Boom	Stick	Bucket	Weight	Ground Pressure	Weight	Ground Pressure	Weight	Ground Pressure
Reach Boom 5.7 m	R2.9 m	1.3 m ³ GD bucket	21 500 kg	44.7 kPa	21 900 kg	39.0 kPa	22 200 kg	35.1 kPa
Reach Boom 5.7 m	R2.5 m	1.3 m ³ GD bucket	21 500 kg	44.7 kPa	21 900 kg	39.0 kPa	22 200 kg	35.1 kPa
VA Boom 5.7 m	R2.9 m	1.3 m ³ GD bucket	22 300 kg	46.4 kPa	22 700 kg	40.5 kPa	23 000 kg	36.3 kPa
VA Boom 5.7 m	R2.5 m	1.3 m ³ GD bucket	22 300 kg	46.4 kPa	22 700 kg	40.5 kPa	23 000 kg	36.3 kPa

Major Component Weights

Base Machine (with boom cylinder without counterweight, front linkage and track shoe)	7000 kg
Long Undercarriage	4470 kg
Counterweight	3700 kg
Reach Boom (5.7 m) includes lines, pins and stick cylinder	1740 kg
Variable Angle Boom includes lines, pins, stick cylinder and VAB cylinder	2540 kg
R2.9 m Stick includes lines, pins, bucket cylinder and bucket linkage	970 kg
R2.5 m Stick includes lines, pins, bucket cylinder and bucket linkage	970 kg
600 mm Triple Grouser Track Shoes (long/per two track)	2690 kg
700 mm Triple Grouser Track Shoes (long/per two track)	3070 kg
790 mm Triple Grouser Track Shoes (long/per two track)	3360 kg
HD 1.19 m ³ Bucket	1060 kg
GD 1.3 m ³ Bucket	920 kg









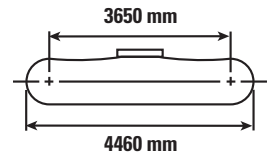
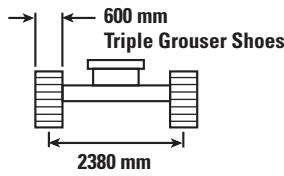
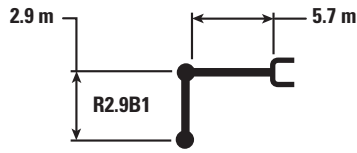



All weights are rounded up to nearest 10 kg except for buckets. Kg were rounded up separately so some of the kg do not match.

Base machine includes 75 kg operator weight, 90% fuel weight, and undercarriage with center guard.

320F L Hydraulic Excavator Specifications

Reach Boom Lift Capacities with Bucket Linkages, without Bucket – Heavy Lift On



		1.5 m		3.0 m		4.5 m		6.0 m		7.5 m				
														m
7.5 m	kg							*4950	*4950			*4300	*4300	6.15
6.0 m	kg							*5400	5250			*3950	3800	7.29
4.5 m	kg							*5950	5100	5550	3600	*3900	3200	7.99
3.0 m	kg					*8650	7400	*6800	4850	5400	3500	*4000	2950	8.36
1.5 m	kg					*10 500	6900	7400	4600	5300	3350	*4200	2850	8.45
0 m	kg			*6600	*6600	11 350	6600	7200	4450	5200	3300	4550	2900	8.26
-1.5 m	kg	*7050	*7050	*11 400	*11 400	11 250	6500	7100	4350	5150	3250	4900	3100	7.78
-3.0 m	kg	*12 100	*12 100	*15 450	12 750	*10 900	6600	7150	4400			5800	3650	6.95
-4.5 m	kg			*12 350	*12 350	*8850	6800					*6700	5050	5.60



ISO 10567



*Indicates that the load is limited by hydraulic lifting capacity rather than tipping load. The above loads are in compliance with hydraulic excavator lift capacity standard ISO 10567:2007. They do not exceed 87% of hydraulic lifting capacity or 75% of tipping load. Weight of all lifting accessories must be deducted from the above lifting capacities. Lifting capacities are based on the machine standing on a firm, uniform supporting surface. The use of a work tool attachment point to handle/lift objects, could affect the machine lift performance.

Lift capacity stays with $\pm 5\%$ for all available track shoes.

Always refer to the appropriate Operation and Maintenance Manual for specific product information.

320F L Hydraulic Excavator Specifications

Reach Boom Lift Capacities with Bucket Linkages, without Bucket – Heavy Lift On

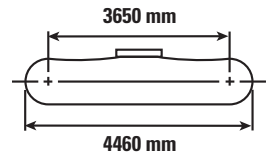
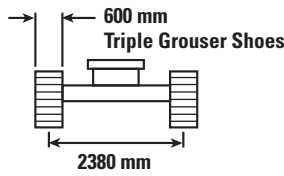
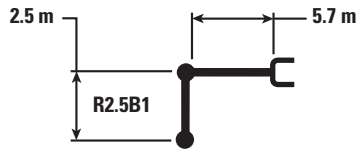

Reach (m)	Unit	3.0 m		4.5 m		6.0 m		7.5 m		m		
		Diagram	Diagram	Diagram	Diagram	Diagram	Diagram	Diagram	Diagram	Diagram	Diagram	
7.5 m	kg									*5150	*5150	5.60
6.0 m	kg					*5850	5150			*4750	4150	6.83
4.5 m	kg			*7350	*7350	*6300	5000	*5200	3500	*4650	3450	7.57
3.0 m	kg			*9250	7250	*7150	4800	5350	3450	*4750	3150	7.96
1.5 m	kg			*10 900	6800	7350	4550	5250	3350	4750	3000	8.05
0 m	kg			11 300	6550	7150	4400	5200	3300	4850	3100	7.86
-1.5 m	kg	*12 000	*12 000	11 250	6550	7100	4350			5350	3350	7.35
-3.0 m	kg	*14 450	12 900	*10 500	6650	7200	4450			6500	4050	6.47
-4.5 m	kg			*7850	6950					*6800	6050	4.98



ISO 10567



*Indicates that the load is limited by hydraulic lifting capacity rather than tipping load. The above loads are in compliance with hydraulic excavator lift capacity standard ISO 10567:2007. They do not exceed 87% of hydraulic lifting capacity or 75% of tipping load. Weight of all lifting accessories must be deducted from the above lifting capacities. Lifting capacities are based on the machine standing on a firm, uniform supporting surface. The use of a work tool attachment point to handle/lift objects, could affect the machine lift performance.

Lift capacity stays with $\pm 5\%$ for all available track shoes.

Always refer to the appropriate Operation and Maintenance Manual for specific product information.

320F L Hydraulic Excavator Specifications

Variable Angle Boom Lift Capacities with Bucket Linkages, without Bucket – Heavy Lift On

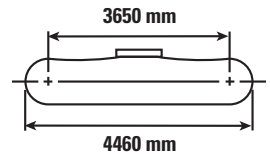
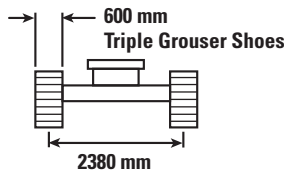
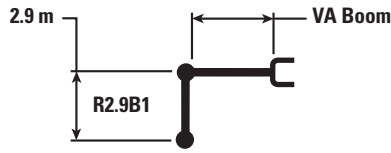

		1.5 m		3.0 m		4.5 m		6.0 m		7.5 m		m		
9.0 m	kg					*5400	*5400					*5450	*5450	4.88
7.5 m	kg					*7400	*7400	*4600	*4600			*4650	4400	6.62
6.0 m	kg					*7500	*7500	*5200	*5200	*4400	3500	*4350	3350	7.69
4.5 m	kg			*11 600	*11 600	*7300	*7300	*5200	5000	*4450	3450	*4250	2850	8.35
3.0 m	kg			*11 000	*11 000	*7050	*7050	*5200	4650	*4700	3300	4200	2600	8.71
1.5 m	kg			*6600	*6600	*7650	6450	*5900	4350	5150	3150	4050	2500	8.79
0 m	kg	*7350	*7350	*6000	*6000	*9950	6100	*6850	4100	5000	3050	4150	2500	8.61
-1.5 m	kg	*9050	*9050	*9300	*9300	10 900	6050	6850	4050	5000	3000	4450	2700	8.16
-3.0 m	kg	*14 300	*14 300	*12 800	12 000	*8850	6150	*6900	4100			*4800	3200	7.34
-4.5 m	kg	*22 350	*22 350	*13 100	12 500	*8350	6450					*7000	5050	5.35



ISO 10567



*Indicates that the load is limited by hydraulic lifting capacity rather than tipping load. The above loads are in compliance with hydraulic excavator lift capacity standard ISO 10567:2007. They do not exceed 87% of hydraulic lifting capacity or 75% of tipping load. Weight of all lifting accessories must be deducted from the above lifting capacities. Lifting capacities are based on the machine standing on a firm, uniform supporting surface. The use of a work tool attachment point to handle/lift objects, could affect the machine lift performance.

VA cylinder is flexible.

Lift capacity stays with ±5% for all available track shoes.

Always refer to the appropriate Operation and Maintenance Manual for specific product information.

320F L Hydraulic Excavator Specifications

Variable Angle Boom Lift Capacities with Bucket Linkages, without Bucket – Heavy Lift On

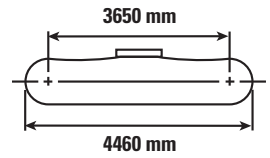
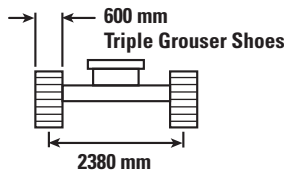
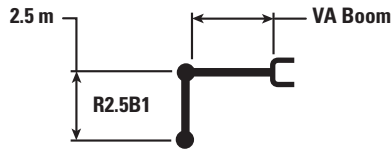

Reach (m)	Unit	1.5 m		3.0 m		4.5 m		6.0 m		7.5 m		m		
		Diagram	Diagram	Diagram	Diagram	Diagram	Diagram	Diagram	Diagram	Diagram	Diagram	Diagram	Diagram	
9.0 m	kg											*6450	*6450	4.11
7.5 m	kg					*7500	*7500	*5350	5100			*5200	4950	6.08
6.0 m	kg					*7450	*7450	*4850	*4850			*4750	3650	7.23
4.5 m	kg			*11 350	*11 350	*7250	*7250	*4600	*4600	*4750	3400	*4650	3050	7.93
3.0 m	kg			*9950	*9950	*6550	*6550	*4550	*4550	*5000	3250	4450	2750	8.30
1.5 m	kg			*7200	*7200	*6850	6300	*5150	4250	5100	3100	4350	2650	8.39
0 m	kg	*9800	*9800	*6400	*6400	*9100	6050	*6150	4100	5000	3050	4450	2700	8.21
-1.5 m	kg	*11 000	*11 000	*9900	*9900	*8650	6050	*6850	4050	*4900	3050	*4500	2950	7.72
-3.0 m	kg	*17 250	*17 250	*10 150	*10 150	*6400	6200	*4800	4150			*4150	3550	6.77
-4.5 m	kg	*23 400	*23 400	*10 500	*10 500							*7350	*7350	4.14



ISO 10567



*Indicates that the load is limited by hydraulic lifting capacity rather than tipping load. The above loads are in compliance with hydraulic excavator lift capacity standard ISO 10567:2007. They do not exceed 87% of hydraulic lifting capacity or 75% of tipping load. Weight of all lifting accessories must be deducted from the above lifting capacities. Lifting capacities are based on the machine standing on a firm, uniform supporting surface. The use of a work tool attachment point to handle/lift objects, could affect the machine lift performance.

VA cylinder is flexible.

Lift capacity stays with ±5% for all available track shoes.

Always refer to the appropriate Operation and Maintenance Manual for specific product information.

320F L Hydraulic Excavator Specifications

Bucket Specifications and Compatibility

						600 mm Triple Grouser			
						3700 kg Counterweight			
	Linkage	Width	Capacity	Weight	Fill	Reach Boom		VA Boom	
		mm	m ³	kg	%	R2.9 m	R2.5 m	R2.9 m	R2.5 m
Without Quick Coupler									
General Duty (GD)	B	600	0.46	549	100	●	●	●	●
	B	750	0.64	620	100	●	●	●	●
	B	900	0.81	666	100	●	●	●	●
	B	1200	1.19	800	100	⊙	⊙	○	⊖
	B	1300	1.30	832	100	⊖	⊙	○	○
	B	1400	1.43	867	100	⊖	⊖	◇	○
Heavy Duty (HD)	B	1050	1.00	879	100	●	●	⊖	⊙
	B	1200	1.19	906	100	⊖	⊙	○	⊖
	B	1200	1.19	917	100	⊖	⊙	○	⊖
	B	1200	1.19	970	100	⊖	⊙	○	○
	B	1300	1.30	960	100	⊖	⊖	○	○
Severe Duty (SD)	B	1050	1.00	962	90	●	●	⊖	⊙
Maximum load pin-on (payload + bucket)					kg	2940	3160	2465	2651
With Pin Grabber Coupler									
General Duty (GD)	B	600	0.46	549	100	●	●	●	●
	B	750	0.64	620	100	●	●	●	●
	B	900	0.81	666	100	●	●	⊖	⊙
	B	1200	1.19	800	100	⊖	⊖	◇	○
	B	1300	1.30	832	100	○	⊖	◇	◇
	B	1400	1.43	867	100	○	○	X	◇
Heavy Duty (HD)	B	1050	1.00	879	100	⊖	⊙	○	○
	B	1200	1.19	906	100	○	⊖	◇	◇
	B	1200	1.19	917	100	○	⊖	◇	◇
	B	1200	1.19	970	100	○	⊖	◇	◇
	B	1300	1.30	960	100	○	○	X	◇
Severe Duty (SD)	B	1050	1.00	962	90	⊙	⊙	○	○
Maximum load with coupler (payload + bucket)					kg	2530	2750	2055	2241

Maximum Material Density:

- 2100 kg/m³
- ⊙ 1800 kg/m³
- ⊖ 1500 kg/m³
- 1200 kg/m³
- ◇ 900 kg/m³
- X Not recommended

The above loads are in compliance with hydraulic excavator standard EN474, they do not exceed 87% of hydraulic lifting capacity or 75% of tipping capacity with front linkage fully extended at ground line with bucket curled.

Capacity based on ISO 7451.

Bucket weight with General Duty tips.

Caterpillar recommends using appropriate work tools to maximize the value customers receive from our products. Use of work tools, including buckets, which are outside of Caterpillar's recommendations or specifications for weight, dimensions, flows, pressures, etc. may result in less-than-optimal performance, including but not limited to reductions in production, stability, reliability, and component durability. Improper use of a work tool resulting in sweeping, prying, twisting and/or catching of heavy loads will reduce the life of the boom and stick.

320F L Hydraulic Excavator Specifications

Bucket Specifications and Compatibility

						600 mm Triple Grouser 3700 kg Counterweight			
	Linkage	Width	Capacity	Weight	Fill	Reach Boom		VA Boom	
		mm	m ³	kg	%	R2.9 m	R2.5 m	R2.9 m	R2.5 m
With Quick Coupler (CW40, CW40s)									
General Duty (GD)	B	600	0.46	502	100	●	●	●	●
	B	750	0.64	587	100	●	●	●	●
	B	900	0.81	653	100	●	●	⊙	●
	B	1200	1.19	767	100	⊖	⊙	○	○
	B	1300	1.30	798	100	⊖	⊖	◇	○
	B	1400	1.43	834	100	○	⊖	◇	◇
Heavy Duty (HD)	B	600	0.46	584	100	●	●	●	●
	B	1200	1.19	873	100	⊖	⊖	◇	○
	B	1300	1.30	927	100	○	⊖	◇	◇
Maximum load with coupler (payload + bucket)					kg	2688	2908	2213	2399

Maximum Material Density:

- 2100 kg/m³
- ⊙ 1800 kg/m³
- ⊖ 1500 kg/m³
- 1200 kg/m³
- ◇ 900 kg/m³

The above loads are in compliance with hydraulic excavator standard EN474, they do not exceed 87% of hydraulic lifting capacity or 75% of tipping capacity with front linkage fully extended at ground line with bucket curled.

Capacity based on ISO 7451.

Bucket weight with General Duty tips.

Caterpillar recommends using appropriate work tools to maximize the value customers receive from our products. Use of work tools, including buckets, which are outside of Caterpillar's recommendations or specifications for weight, dimensions, flows, pressures, etc. may result in less-than-optimal performance, including but not limited to reductions in production, stability, reliability, and component durability. Improper use of a work tool resulting in sweeping, prying, twisting and/or catching of heavy loads will reduce the life of the boom and stick.

320F L Hydraulic Excavator Specifications

Work Tool Offering Guide*

Boom Type	Reach Boom		VA Boom	
Stick Type	2.9 m	2.5 m	2.9 m	2.5 m
Undercarriage	Long			
Hydraulic Hammer	H115E s H120E s H130E s	H115E s H120E s H130E s	H115E s H120E s H130E s	H115E s H120E s H130E s
Multi-Processor	MP318 CC Jaw MP318 D Jaw MP318 P Jaw ^{^>>} MP318 S Jaw MP318 U Jaw ^{^>>}	MP318 CC Jaw MP318 D Jaw MP318 P Jaw MP318 S Jaw MP318 U Jaw	MP318 CC Jaw ^{^>>} MP318 D Jaw ^{^>>} MP318 P Jaw [^] MP318 S Jaw ^{^>>} MP318 U Jaw [^]	MP318 CC Jaw MP318 D Jaw MP318 P Jaw ^{^>>} MP318 S Jaw MP318 U Jaw ^{^>>}
Pulverizer	P215	P215	P215	P215
Crusher	P315	P315	P315 ^{^>>}	P315
Demolition and Sorting Grapple	G315B-D/R G315B-WH G315B-D/R fixed CAN	G315B-D/R G315B-WH G315B-D/R fixed CAN	G315B-D/R ^{^>>} G315B-WH ^{^>>} G315B-D/R fixed CAN	G315B-D/R G315B-WH G315B-D/R fixed CAN
Scrap and Demolition Shear	S320B ^{^>>} S325B##	S320B S325B##	S320B [^] S325B##	S320B ^{^>} S325B##
Compactor (Vibratory Plate)	CVP110	CVP110	CVP110	CVP110
Orange Peel Grapple				
Rippers				
Pin Grabber Coupler	Cat PG			
Dedicated Quick Coupler	CW-40 CW-40s CWAC-40 (autoconnect)			

These work tools are available for the 320F L.
Consult your Cat dealer for proper match.

* Offerings not available in all areas. Matches are dependent on excavator configurations. Consult your Cat dealer to determine what is offered in your area and for proper work tool match.

Boom Mount

[^] Work over the front only with CW (Pin-on and CW)

^{^>} Work over the front only with CWAC (Pin-on, CW and CWAC)

^{^>>} Work over the front only with Cat PG or CWAC (Pin-on, CW, Cat PG and CWAC)

Note: Demolition and Sorting Grapple:

D-Demolition shells, R-Recycling shells

fixed CAN – fixed hinge plates for CW quick coupler usage.

320F L Standard Equipment

Standard Equipment

Standard equipment may vary. Consult your Cat dealer for details.

ENGINE

- C4.4 ACERT diesel engine
- Stage IV emission standards
- 3000 m altitude capability with no derate
- Up to B20 biodiesel capable
- One-touch low idle with automatic engine shutdown
- Electric refueling pump with auto shutoff
- Electric lifting pump
- Radial seal air filter
- Variable fan speed control with viscous clutch
- Air precleaner
- Standard, economy and high power modes
- Three stage fuel filtration system with water separator and indicator
- Two-speed travel
- 52° C high ambient cooling capability, with derate from 48° C

HYDRAULIC SYSTEM

- Electric boom regeneration circuit
- Stick regeneration circuit
- One-touch Heavy Lift mode
- Reverse swing damping valve
- High-performance hydraulic return filter (capsule filter type)
- Automatic swing parking brake
- Capability of installing additional auxiliary circuits

CAB

- ROPS certified cab
- Mirrors
- Pressurized operator station with positive filtration
- Laminated glass front upper window and tempered other windows
- Sliding upper door window (left-hand cab door)
- Removable lower windshield with in cab storage bracket

- Openable skylight as emergency exit
- Interior:
 - Glass-breaking safety hammer
 - Coat hook
 - Beverage holder
 - Literature holder
 - Interior lighting
 - AM/FM radio mounting (DIN size)
 - Two 12V stereo speakers
 - Storage shelf suitable for lunch or toolbox
 - Power supply with 12V, two power outlets (10 amp)
 - Thumb wheel modulation joystick for use with combined auxiliary control
 - Sun screen
 - Air conditioner, heater and defroster with climate control
- Seat:
 - Seat belt, 51 mm
 - Adjustable armrest
 - Height adjustable joystick consoles
 - Neutral lever (lock out) for all controls
 - Travel control pedals with removable hand levers
 - Capability of installing two additional pedals
 - Two speed travel
 - Floor mat, washable
 - Adjustable high-back, heated seat with air suspension
- Monitor:
 - Clock
 - Video ready
 - Color LCD display with warning, filter/fluid change, and working hour information
 - Language display (full graphic and full color display)
 - Machine condition, error code and tool mode setting information
 - Start-up level check for engine oil, engine coolant and hydraulic oil
 - Warning, filter/fluid change and working hour information
 - Fuel consumption meter
- Windshield:
 - 70-30 split, sliding, removable lower windshield with in cab storage bracket

UNDERCARRIAGE & STRUCTURES

- 3700 kg counterweight
- Grease-lubricated track link
- Swivel guard
- Track guiding guards:
 - Segmented, two pieces

ELECTRICAL

- Maintenance-free battery
- Centralized electrical disconnect switch
- 85 amp alternator
- Programmable time delay working lights (halogen); storage box mounted (one), cab mounted (two), boom mounted (two)

SERVICE & MAINTENANCE

- Engine oil, fuel, and hydraulic oil filters grouped for ease of maintenance
- Sampling ports for Scheduled Oil Sampling (S·O·SSM)
- Three side-by-side cooling package for easy maintenance
- PM (Preventative Maintenance) ready (QuickEvacTM)

SAFETY & SECURITY

- Rear and right hand side vision camera
- Handrails
- Bolt-free service platform with anti-skid plate
- Neutral lever (lock out) for all controls
- Ground-level accessible secondary engine shutoff switch in cab
- Signaling/warning horn
- Safety hammer for cab evacuation
- Travel alarm

INTEGRATED TECHNOLOGIES

- Product Link
- Rear vision camera

Optional Equipment

Optional equipment may vary. Consult your Cat dealer for details.

ENGINE

- Cold weather starting package, -32°C or -18°C

HYDRAULIC SYSTEM

- HP hydraulic lines for boom and stick
- MP hydraulic lines for boom and stick
- QC hydraulic lines for boom and stick
- QC control

TRACKS

- 600 mm triple grouser shoes
- 700 mm triple grouser shoes
- 790 mm triple grouser shoes

FRONT LINKAGE

- 5.7 m Reach boom (with BLCV/SLCV/SmartBoom™)
 - R2.9 m stick
 - R2.5 m stick
- VA boom (with BLCV/SLCV/SmartBoom)
 - R2.9 m stick
 - R2.5 m stick
- Bucket linkage
 - B1 linkage with lifting eye
- CW dedicated or Pin Grabber quick coupler

GUARDS

- FOGS capability

CAB

- Straight travel pedal

For more complete information on Cat products, dealer services, and industry solutions, visit us on the web at www.cat.com

AEHQ7768 (01-2016)

© 2016 Caterpillar
All rights reserved

Materials and specifications are subject to change without notice. Featured machines in photos may include additional equipment. See your Cat dealer for available options.

CAT, CATERPILLAR, SAFETY.CAT.COM, their respective logos, "Caterpillar Yellow" and the "Power Edge" trade dress, as well as corporate and product identity used herein, are trademarks of Caterpillar and may not be used without permission.

VisionLink is a trademark of Trimble Navigation Limited, registered in the United States and in other countries.

