

6020B

Hydraulic Shovel



Engine

Engine Model	Cat® C32 ACERT™	
Gross Power – SAE J1995	778 kW	1,043 hp
Net Power – SAE J1349	778 kW	1,043 hp

Bucket

Standard Bucket Capacity – Backhoe (Heaped 1:1)	12.0 m ³	15.7 yd ³
--	---------------------	----------------------

Operating Specifications

Bucket Payload	22 tonnes	24 tons
Operating Weight	224 tonnes	247 tons

6020B Features

When we invited you to help us design the first B Series Cat Hydraulic Mining Shovel, you gave us three top priorities: Make it safe, keep it simple and make it reliable. We responded by developing the 6020B, a brand new, clean-sheet design that delivers the simplicity and reliability you desire, with valuable modern design features that set it apart from the competition:

- *Safety-enhancing state-of-the-art operator's cab with class-leading visibility.*
- *Ready serviceability with a unique walk-through and exchangeable power module.*
- *Industry-leading efficiency with dedicated pump flow allocation technology.*
- *Quick field assembly via its modular design.*

Contents

State-of-the-Art Operator's Cab	4
Advanced Hydraulic System.....	6
Independent Oil Cooling System	8
Electronic Control System	9
Safety	10
Serviceability	12
Customer Support.....	14
Loading/Hauling Efficiency.....	16
Drive System.....	17
Cat MineStar™ System and Technology Solutions	18
Swing System	20
Undercarriage	21
Cat Buckets and Ground Engaging Tools.....	22
Machine Structures.....	24
Sustainability	25
Specifications.....	26
Optional Equipment.....	31





6020B – It's Not Complicated

You need a shovel that works. A simple, durable digger that gets the job done efficiently and safely. The Cat 6020B is engineered from the ground up with ease of use in mind. It's easy to assemble, easy to learn, easy to operate and easy to maintain. So you can concentrate on running a safe, productive operation. The new Cat 6020B. It's not complicated.

State-of-the-Art Operator's Cab

Protecting and Supporting Your Most Important Asset: the Operator





Optimizing Operator Situational Awareness with Class-leading Cab Visibility

- Direct view of tracks, while seated in the operator's station, via floor window for safe and easy machine repositioning and underfoot obstacle avoidance.
- Safe machine positioning and truck loading via large windshield and side windows.
- Multiple strategically positioned and high-powered LED lights for maximum illumination of the digging area in dark conditions.
- Heavy-duty wiper ensures good visibility in inclement weather conditions.

Supporting Peak Operator Performance with Enhanced Training Capability

- First in class and patented three-seat design with unobstructed view of digging environment from all seats.
- Elevated observer's work station, positioned behind the operator seat, provides space for a laptop and great visibility of the operator station and the digging environment.
- Dual in-cab E-stop button easily accessible from both trainer seats and operator station.

Maximizing Operator Alertness and Effectiveness with Leading Comfort Features

- Extremely quiet and fully pressurized cab environment.
- Ergonomic operator seat and controls with armrest adaptable to operator preference.
- 10 inch touch-screen display includes troubleshooting aids and machine documentation.
- Extensive in-cab air distribution via powerful HVAC unit and multiple, optimally positioned, vents.
- Cab module supported with rubber mounts for shock absorption.
- Electro-servo control system ensures no hydraulic lines are present in the cab for a clean, quiet, and odorless environment.



Advanced Hydraulic System

Reliable Performance from an Efficient, Clean,
and Serviceable System



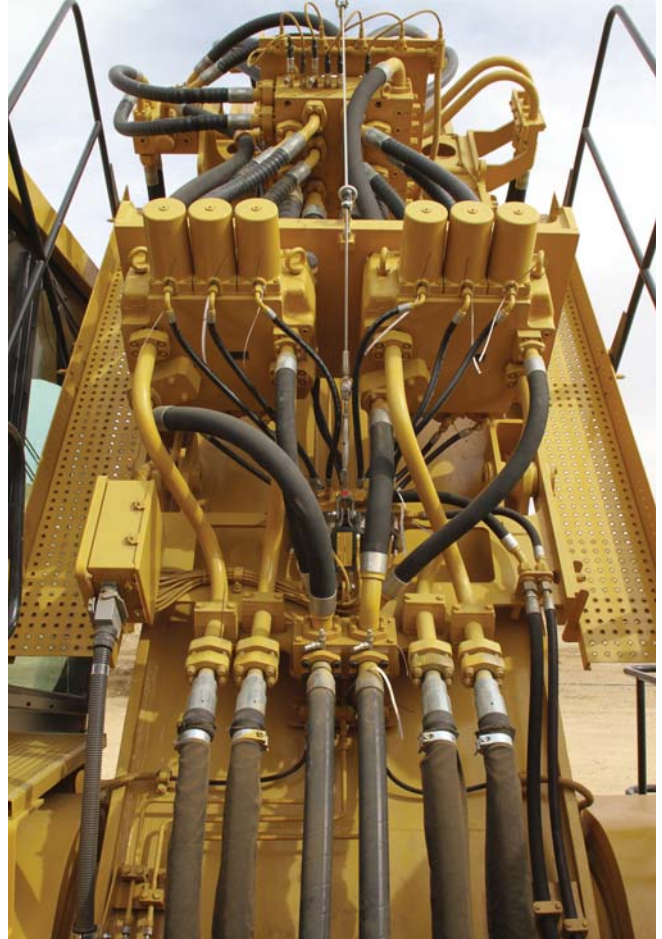
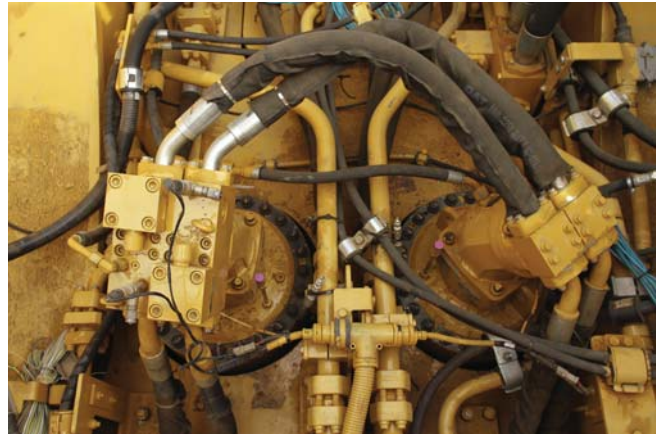

Fuel Savings as a Result of Best-in-Class Energy Efficiency

More efficient hydraulic pump utilization, reduced energy losses, and increased fuel savings are realized with our innovative, patent-pending dedicated pump-flow allocation technology.

Additional fuel savings resulting from boom float feature, improving energy efficiency.

Straightforward and Safe System Maintenance

Providing easier access for service and de-cluttering of the mainframe, the hydraulic valve block is mounted on the boom.

Consistent Oil Cleanliness for Dependable Hydraulic System Performance

The hydraulic system design has been optimized for peak performance and reliability.

- Machine comes equipped with standard high-pressure and return oil filtration.
- A separate kidney loop provides continuous filtration and optimum oil cleanliness at all times, supporting the hydraulic system.



Independent Oil Cooling System

Efficient Oil Cooling for Extended Component Life

Protect and Extend the Life of Your Hydraulic Components and Seals

Providing an efficient means of cooling, particularly in demanding applications, our unique independent oil cooling system will extend the life of your hydraulic shovel's components.

More Efficient Oil Cooling

Our system is independent of return oil, achieving efficiency through the utilization of dedicated pumps that provide cooling capacity as needed, whether the engine is idling or under load. That means optimum oil temperature is being maintained, even while your operator waits for the next truck to load. Competitive hydraulic shovels only provide cooling when the machine is working and the engine is under load.

Additional efficiency is achieved via:

- Variable oil flow
- Variable fan speed
- Auto-reversible fan feature for self-cleaning

Optimal Oil Temperature Maintained

Our unique independent oil cooling system ensures that system operating temperatures remain within the optimal operating viscosity range at all times.

Electronic Control System

Operate with Confidence



Enhanced Control Response and Optimized Hydraulic Engine Load Management

Help your team meet productivity and performance standards with our intuitive, informative on-board electronics.

Electro-hydraulic Servo Control

- **Enhanced Control Response Resulting in Increased Operator Comfort**

The system relays actuating signals from the joysticks, delivering load independent and precise machine reactions that reduce operator fatigue.

- **Increased Up-time**

Up-time is increased as a result of simplified troubleshooting and advanced diagnostic capabilities.

- **Clean and Quiet Cab Environment**

No hydraulic lines are present in the cab or the cab module, ensuring a clean, odorless arrangement with less noise.

Control and Monitoring Platform (CAMP)

- **Reduced Control System Inventory**

Streamlined system requires only two controllers for all functions (i.e., drive train and servo).

- **Less Fuel Consumption**

Both engine and hydraulic pumps work in optimal range of performance during the entire digging cycle, reducing fuel burn.

Safety

Designed with Your Safety as Our Top Priority





Sharing your commitment to safety, and driven by our commitment to Zero Harm, we work tirelessly to design the safest machines possible to protect your most important asset; your employees.

Some examples of the safety-enhancing features of the Cat 6020B Hydraulic Mining Shovel include the following:

Operator Environment

- Optimized operator situational awareness and safe machine positioning/truck-loading via class leading cab visibility.
- Safe training environment facilitated by unobstructed view of digging environment and accessibility of E-stop button from both seat belt equipped trainer seats.
- Enhanced operator safety with fuel and hydraulic oil tanks positioned away from the cab.
- FOPS certified cab with safety glass windshield.
- Cab equipped with emergency hammer for quick escape and ready access to emergency ladder.

Machine Access

- Safe access to power module components from machine platform and counterweight.
- Safe movement about the machine via wide and slip-resistant walkways, limited walkway elevation changes (steps up/down), and minimized trip hazards.
- Quick exit from machine during emergency facilitated by three means of egress.

Sound Suppression

- Excellent power module and cab sound suppression system to protect operators and service personnel.

Electrical System

- Safe electrical maintenance facilitated by lockable battery isolation and starter lockout switch.

Emergency Shut-offs

- Multiple emergency stop buttons strategically located around machine for immediate engine shut-down, including a pull switch accessible from the ground.



Serviceability
Service Friendly for Greater Uptime

Designed to Start Producing Almost Immediately Upon Arrival on Site

The modular design of the 6020B facilitates quick field assembly. The average assembly time in typical conditions is 14 days; however, similar assembly times were achieved with pilot machines assembled at -30°C (-22°F).

Reduced Downtime Due to Exchangeable Power Module

Our exchangeable power module, which contains the most vital machine operating systems, can be quickly removed and replaced with a spare power module to increase machine uptime.

This capability also allows for transporting of the power module away from the production area to allow service and repair in a safe, convenient, and clean environment.

Service Friendly, with Unparalleled In-class Component Accessibility

The 6020B was designed to be easily serviced and maintained:

- Exceptional component accessibility and weather protection via first-in-class and spacious walk-through power module.
- Superior swing system component accessibility via boom-mounted hydraulic valve block.
- Ground-level accessible service fluid fill points and jump start receptacle.
- Automatic centralized lubrication system.
- 24 hour non-stop machine operation capability.
- Extensive troubleshooting capability via hydraulic service ports.
- Streamlined maintenance and parts availability with integrated Cat components.

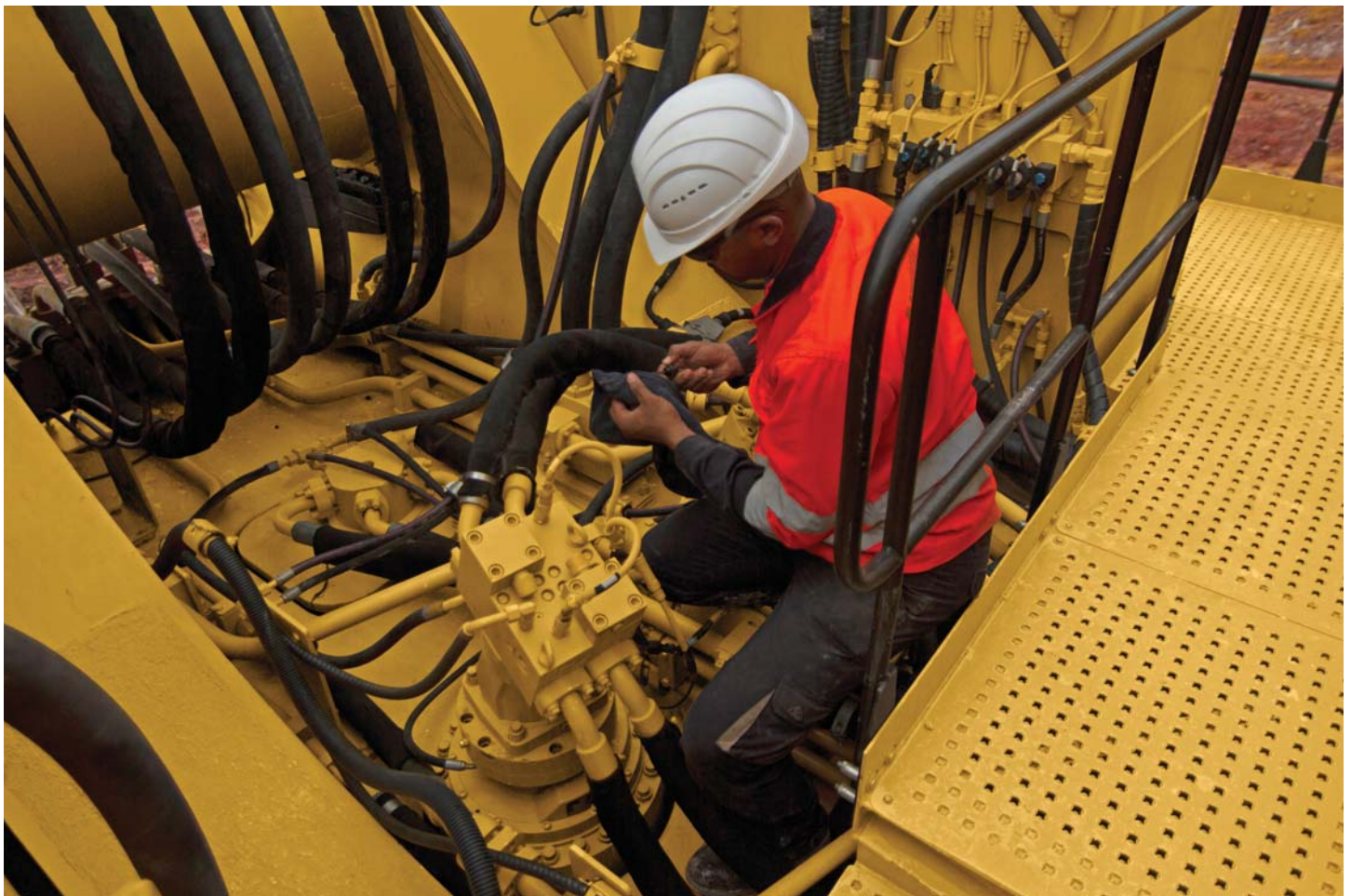



Customer Support

Seamless Dealer Support

Parts Available When You Want Them

Receiving 6020B parts from your local Cat dealer is streamlined through the optimized use of Cat components, integrated part numbers, and stocking of parts in local Caterpillar warehouses. Your 6020B will be supported 24 hours a day, 7 days a week, by a worldwide network of parts distribution facilities, dealer service centers, and technical training facilities to keep it up and running at peak performance levels.

A Single Source for All Service and Maintenance Needs

With the use of Cat components throughout, you can rest assured that your local Cat dealer is your most knowledgeable and trusted single source for your 6020B service and maintenance needs. Cat dealer expert technicians have the unique knowledge, experience, training, and tooling necessary to fully support your 6020B hydraulic shovel, no matter the need or where your site is located.

Continued Support throughout the Life of Your 6020B

Consistent with any piece of Cat equipment, the 6020B is designed and built to provide maximum productivity, capability and operating economy throughout its working life. To help you meet these performance levels with your 6020B, Cat dealers offer a wide range of service plans that maximize uptime and return on your investment, including:

- Preventative maintenance programs
- Diagnostic programs, such as scheduled oil sampling and technical analysis
- Rebuild and reman options
- Customer support agreements

And although the 6020B is designed for easy operation, your Cat dealer can arrange training programs to help your operators improve productivity, increase uptime, reduce operating costs, and enhance safety.

No One Knows Your 6020B Hydraulic Shovel Better

The vast majority of Cat dealers across the globe have supported our line of hydraulic shovels for over a decade, so they are uniquely equipped to optimize the performance of your 6020B with their unmatched Cat hydraulic shovel expertise. This expertise includes a deep understanding of how the 6020B is best applied and utilized in all types of applications, so they can take your site-specific factors into account to help lower your operating and maintenance costs.





Loading/Hauling Efficiency

Move More Material with Optimal Pass Match Pairings

Achieve Targeted Loading/Hauling Production with Perfectly Paired Cat Hydraulic Shovels and Mining Trucks

For full truck payloads with minimum loading time, an efficient loading/hauling system begins with an optimized equipment match. Cat hydraulic shovels are matched with Cat mining trucks to maximize volume of material moved at the lowest operating cost per ton.

The 6020B was designed to be an optimal pass-match with our popular 777 Series off-highway truck. It is also capable of pairing with the 785 Series mining truck, where applicable.

6020B Pass Match with Cat Off-highway/Mining Trucks

	777G/777F/777D	785D/785C
	96.9 tonne (106.9 ton)	136 tonne (150 ton)
6020B	4-5	5-6



Drive System

Simple and Reliable System
Supported Seamlessly

Simple and Cost-effective Single Engine Concept

When we asked you what design features you desired most from a 200 metric ton (220 short ton) size class hydraulic backhoe, a single-engine platform was a top request. We listened by designing the 6020B with a single C32 engine for reliable performance and simple and cost effective service when needed.



Reliable Cat C32 ACERT Tier 2 Engine

Delivering durable, reliable power that will keep your 6020B producing, the C32 has proven its ability to perform in harsh mining conditions throughout the world. Offering low operating costs, and supported 24/7 by your local Cat dealer, the C32 will help you achieve your production and profitability targets, reliably.

ACERT Technology

The development of ACERT Technology began with the search for a better way to reduce diesel engine emissions, and culminated in a revolutionary engine design breakthrough that burns fuel more precisely than ever before. Lower combustion temperatures reduce emissions and prolong the life of lighter, more power-dense engine platforms. It also varies the injection timing based on factors like engine load and speed for optimum performance under a wide range of operating conditions, including mining.

Worldwide Cat Engine Support

Our engines are only as good as the service and support that stand behind them. Highly trained and experienced service technicians at your local Cat dealership are ready with whatever you need, wherever and whenever you need it. They know the Cat C32 engine inside and out, so they can promptly diagnose issues and keep your 6020B running at peak performance.



Cat MineStar System and Technology Solutions

Evolving Your Mine for Greater Safety and Productivity

Helping You Enhance Safety and Productivity through Technology

Aimed at enhancing the productivity and profitability of your 6020B hydraulic mining shovel, we currently offer a combination of Cat MineStar System offerings and Cat hydraulic mining shovel technology solutions.

Cat MineStar System

Helping you achieve your goals for enhanced mine site safety, improved efficiency, reduced operating costs, and greater profitability, the Cat MineStar System provides the most comprehensive suite of mining technology products in the industry. It consists of a number of configurable capability sets – Fleet, Terrain, Detect, Health, and Command – that allow you to scale the system to your mine site needs. Cat MineStar System helps you manage everything from material tracking to sophisticated real-time fleet management, machine health systems, autonomous equipment, and more.

The Cat 6020B is “MineStar ready”, capable of utilizing four of the Cat MineStar System capability sets:

- **Health**

Health delivers critical event-based machine condition and operating data for your entire fleet. It includes comprehensive equipment health and asset monitoring capabilities with a wide range of diagnostic, analytic and reporting tools.

- **Fleet**

Fleet provides real-time machine tracking, assignment and productivity management, providing a comprehensive overview of all your asset operations from anywhere in the world.

- **Terrain**

Terrain enables high-precision management of drilling, dragline, grading and loading operations through the use of guidance technology. It increases machine productivity and provides you real-time feedback for improved efficiency.

- **Detect**

Detect provides equipment operators with enhanced awareness for increased site safety, using a combination of radars, an in-cab display, and multiple cameras.

Please speak to your local dealer for more information on MineStar for the 6020B.

Hydraulic Shovel Technology Solutions

- **Monitoring and Diagnostic System**

Enhancing diagnostic capabilities and providing detailed troubleshooting functions, our Board Control System uses sensors throughout the machine to monitor operating data, record faults, and notify the operator audibly and visually. This promotes the earliest possible detection of faults and allows for timely maintenance planning and assistance for speedy repair.





Swing System

Efficiency Enabling and Simplified Design

Enabling the Use of Advanced Hydraulics with an Open-loop Swing Circuit

The 6020B includes an open-loop swing circuit that interacts well with its newly designed advanced hydraulics. Utilizing patent-pending dedicated pump flow allocation technology, hydraulic pumps are allocated to individual circuits on demand, allowing all produced oil flow to be translated into cylinder motion, optimizing hydraulic efficiencies and reducing heat generation. To fully leverage the advantages of this innovative technology, the open-loop swing system was incorporated for its use of a common set of pumps to serve all functions and the flexibility it offers for utilization of hydraulic flow.

More Reliable Swing Component Life

Extending component life and ultimately improving machine uptime, our swing system includes a triple-race swing roller bearing with internal gearing connected to an automatic lubrication system.

For added reliability, all lube lines supplying the swing roller bearing are located inside the superstructure for maximum protection.

Better wear of undercarriage components

- Even idler slide wear and extended component life result from the floating push tube.
- Low wear drive system via induction hardened and high quantity of sprocket teeth.
- Optional rough terrain undercarriage protection kit available to further protect undercarriage components from harsh ground conditions.

Superior serviceability

- The 6020B's automatic track tensioning system is a simplified design that requires no manual adjustment.
- Service simplified by externally serviceable break.

Reliable crawler performance

- Exceptional track guidance via standard track guides the entire length of the crawler.
- Usage of a skid plate, instead of a third support roller in the center, helps to prevent build-up of material and jamming of rollers.
- Travel motors and gearboxes are well protected by robust steel covers.



Undercarriage

Extended Component Life and Superior Serviceability

Cat Buckets and Ground Engaging Tools

Improved Productivity, Operational Efficiency, and Serviceability

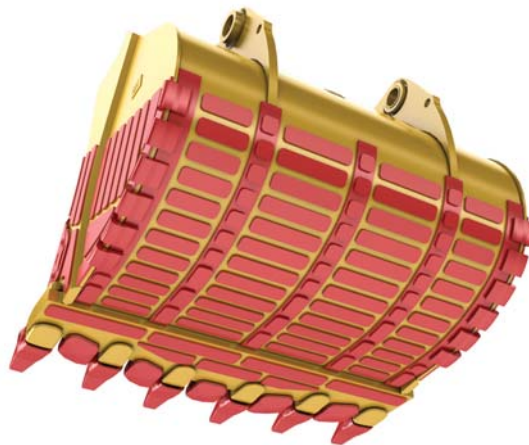
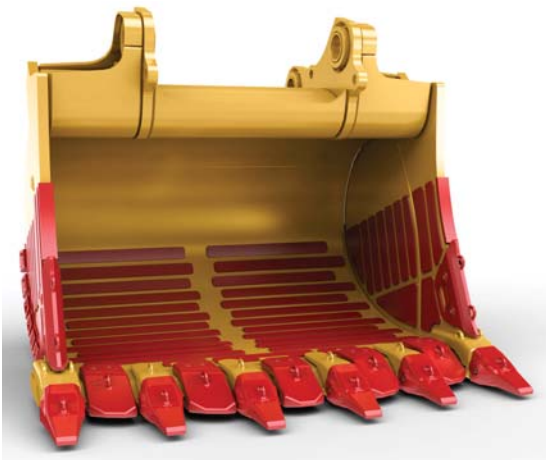

- 1) MultiPlus Rock Bucket
- 2) High Abrasion Rock Bucket



Cat Buckets Increase Productivity

Cat buckets are designed to match your Cat 6020B mining shovel, providing optimum payload and machine efficiency while protecting your investment. Bucket wear surfaces are armored with replaceable wear materials to extend the life of your bucket. Cat buckets are easy to rebuild, with all parts available through your Cat dealer. Trust Cat to give you long service life without adding excessive weight.

Key Features:

- Sized to match the 6020B mining shovel and your application.
- Protected with high abrasion materials matched to the wear characteristics of your application.
- Rebuildable, with all wear components (shown below in red) available as mechanically attached service parts.

MultiPlus Rock Buckets

Cat MultiPlus rock buckets are suited for standard rock and soil applications, which constitutes the vast majority of mining and quarry/aggregate applications.

High Abrasion Rock Buckets

High abrasion rock buckets are more heavily guarded for use in dense rock and aggressive digging conditions.

G.E.T. Quality and Performance Made Easy

Increase your operational efficiency and productivity with hammerless Cat G.E.T. designed specifically for the 6020B hydraulic mining shovel. By designing our own G.E.T., we are able to take a production focus, rather than a component focus, to optimize performance across the entire machine. And like all Cat G.E.T., it is fully supported by your local Cat dealer.

- **Simple:** No special tools required for Removal & Install
- **Fast:** One turn to lock and unlock
- **Safe:** No hammer required to service the lip system
- **Options:** Four tip shapes to optimize your production



Machine Structures

Built-in Durability You Can Rely On

Large and Robust Structures Designed and Fabricated to Withstand Your Toughest Digging Conditions

To extend service life and ensure that your 6020B keeps producing, our structures are designed for durability and dependability. Extended performance in the harsh digging conditions you face daily is accomplished through selection of high-strength steels and rugged castings, joined and thermally stress-relieved to create a reliable external shell.

- Manufactured from high-strength steel for durability.
- Full penetration, profiled and ground welds at critical junctures.
- MT, UT, and X-ray inspections on select welds ensure quality.

Reliable Front Attachment Structures

The 6020B boom and stick utilize high-strength steel and rugged castings that are joined and thermally stress relieved for optimum structural life.

- Heavy castings at all pivot points.
- Single-plate side walls.
- Better flow of forces and less welding seams, as top chords are made of one bend plate.
- Entire boom and stick are stress relieved after welding for maximized reliability.
- Extensive use of Finite Element Analysis (FEA).

Fully Tested and Validated

All 6020B structures have been fully tested and validated at our state-of-the-art proving ground in Tucson, AZ (U.S.A.).



Sustainability

Higher Standards for a Better Tomorrow

Meeting the needs of today without compromising the needs of tomorrow is the goal for all Cat machinery. The commitment to helping you operate safely and sustainably is affirmed in the design of the 6020B hydraulic mining shovel.

Cat 6020B Sustainability

- **Rebuilds**

Decrease your energy use and material consumption with a machine design that facilitates rebuilding.

- **Service**

Ground-level accessible service fluid fill points ensure fast, easy, and secure replenishment of machine fluids.

- **Sound Levels**

Reduced operator and spectator sound levels result in less impact on the communities where they operate. The 6020B provides sound suppression on its power module to keep spectator sound levels low, and provides a sound suppressed cab for an extremely quiet working environment for the operator.

- **Component Life**

The 6020B's automatic centralized lubrication system maintains the proper grease lubrication on working surfaces, significantly extending component life.

6020B Hydraulic Shovel Specifications

General Data

Operating Weight	224 tonnes	247 tons
Engine Output SAE J1995	778 kW	1,043 hp
Standard Bucket Capacity	12 m ³	15.7 yd ³

Operating Weight – Backhoe

Standard Track Pads	800 mm	2 ft 7 in
Operating Weight	224 000 kg	493,830 lb
Ground Pressure	21.7 N/cm ²	31.4 psi

Diesel Engine

Make and Model	Cat C32 (Tier 2)	
Rated Net Power ISO 3046/1	778 kW	1,043 hp, 1,800 min ⁻¹
Rated Net Power SAE J1349	778 kW	1,043 hp, 1,800 min ⁻¹
Rated Gross Power SAE J1995	778 kW	1,043 hp, 1,800 min ⁻¹
No. of Cylinders	12	
Bore	145 mm	5.71 in
Stroke	162 mm	6.38 in
Displacement	32 L	1,959 in ³
Aspiration	Turbocharged and air-to-air aftercooled	
Maximum Altitude without Deration above sea level (a.s.l.)	2000 m	6,560 ft
Alternator	275A	
Emission Certification	U.S. EPA Flex	
Fuel Tank Capacity	3600 L	951 U.S. gal

- Hydraulically driven radiator fan with variable electronically controlled fan speed
- Reversible fan for self cleaning of engine radiator
- Micro processed engine management
- Heavy-duty air filters
- Two-stage fuel filter
- Additional high-capacity water separator including electric priming pump
- Large fuel tank allows for 24 hour machine operation

Electrical System

System Voltage	24V
Batteries (12V each)	6 × 210 Ah
In Series/Parallel Installation	630 Ah – 24V
Battery isolation relays	manual lockable disconnect switch and automatic disconnect relay

- Emergency stop buttons inside cab, accessible from all seating locations, and engine module
- Additional ground-level emergency stop
- 8 LED high-brightness working flood lights
 - 6 for working area
 - 2 for rear end
- 2 LED high-brightness access flood lights
- 7 LED service lights
- 1 beacon lamp on cab roof

Hydraulic System with Electronic Pump Management

Main Pumps	6 × variable swash plate pumps	
Maximum Total Oil Flow	2350 L/min	621 U.S. gal/min
Maximum Swing Oil Flow	783 L/min	216 U.S. gal/min
Maximum Pressure, Attachment	310 bar	4,495 psi
Maximum Pressure, Travel	310 bar	4,495 psi
Maximum Pressure, Swing	350 bar	5,080 psi

- Electronic pump management contains:
 - Electronic load limit control
 - Dedicated circuit pump allocation
 - Automatic return of main pumps to zero flow
 - Automatic rpm reduction of engine speed during working breaks
 - Reduced oil flow of main pumps at high hydraulic oil temperature and at high engine temperature
- Pressure cut-off function for all main pumps
- Cooling of pump transmission gear oil
- Filters:
 - Full-flow high-pressure filters (100 µm) for main pumps, installed directly behind each pump
 - Full-flow filters (10 µm) for complete return circuit
 - Full-flow filters (10 µm) for cooling return circuit
 - Pressure filters (6 µm) for servo circuit
 - Transmission oil filter (40 µm)

6020B Hydraulic Shovel Specifications

Hydraulic Oil Cooling

Oil Flow of Cooling Pumps	800 L/min	211 U.S. gal/min
Diameter of Fan	1500 mm	4 ft 11 in

- Cooling system fully independent of all main circuits, i.e. controlled cooling capacity available whenever engine is running
- Variable electronically controlled flow of oil through cooler and fan speed
- Reversible fan for self cleaning of oil cooler
- Superior cooling efficiency to ensure optimum oil temperature

Swing System

Swing Drives	2 compact planetary transmissions with axial piston motors
Parking Brake	Wet multiple-disc brake, spring-loaded/hydraulically released
Maximum Swing Speed	4.9 rpm
Swing Ring	Triple-race roller bearing with sealed internal gearing

- Open swing circuit with auto slow down when joysticks in neutral
- All slew ring raceways and grease tub for internal gearing supplied by automatic, central lubrication system

Centralized Service Area

Centralized service area accessible from ground level.

- Equipped with:
- Quick couplings for:
 - Diesel fuel
 - Engine coolant
 - Pump transmission gear oil
 - Engine oil (oil pan)
 - Hydraulic oil
- Cat jump-start socket
- Indicator light for hydraulic tank full

Undercarriage

Travel Speed (2 Stages):		
1st Stage (maximum)	1.2 km/h	0.75 mph
2nd Stage (maximum)	2.7 km/h	1.68 mph
Maximum Tractive Force	1066 kN	239,560 lbf
Gradeability of Travel Drives	Approximately 56%	
Track Pads (each side)	49	
Bottom Rollers (each side)	8	
Support Rollers (each side)	2 plus slide	
Travel Drives (each side)	1 planetary transmission with 2 two-stage axial piston motors	
Parking Brakes	Wet multiple disc brake, spring loaded/hydraulically released	

- Forged double-grouser track pads
- Chain links connected by hardened pins and bushings
- All running surfaces of sprockets, idlers, rollers and track chain links hardened
- Fully hydraulic self-adjusting track tensioning system with accumulator
- Automatic hydraulic retarder valve to prevent overspeed on downhill travel
- Audible travel alarm

Operator's Cab

Operator's Eye Level (approximate)	5.5 m	18 ft 1 in
Internal Dimensions of Cab:		
Length	2230 mm	7 ft 4 in
Width	1625 mm	5 ft 4 in
Height	2070 mm	9 ft 9 in

- Large cab floor window with removable grating for easy cleaning
- Pneumatically cushioned and multi-adjustable operator seat with lumbar support, safety belt, head- and armrests
- Safety switch in operator's seat for automatic motion shutdown
- Joystick integrated in adjustable seat armrest
- Full sized trainer seat with safety belt and work table
- Auxiliary fold-away seat with safety belt for 3rd person
- FOPS (rock guard; approved according to ISO 3449) compliant
- Windshield with parallel intermittent wiper/washer
- Roller blinds
- New Board Control System (BCS): Electronic monitoring, data logging and diagnostic system for vital signs and service data of engines, hydraulic and lubrication system, featuring:
 - Robust instrument panel including large (254 mm/10 in) color touch screen
 - On-screen PDF documentation (e.g. operating instructions, technical handbook, spare parts catalog, electric circuit diagram)
 - On-screen troubleshooting assistance
 - Graphical data logging
 - Fault memory capabilities
 - USB, Lan (TCP/IP) and CAN BUS interfaces for data export
- Machine access via retractable access stairway, stairway angle approximately 45°, hydraulically operated
- Additional emergency ladder in close proximity to emergency escape window

6020B Hydraulic Shovel Specifications

Automatic Lubrication System

Capacity of Grease Barrel 205 L 54 U.S. gal

- Single-circuit progressive system with hydraulically driven heavy-duty pump and electronic time control
- Grease supplied to swing roller bearing, all pivot points of attachment, and swing gearbox bearing
- System condition and failures displayed by Board Control System

Attachment

- Boom and stick torsion-resistant with welded box design
- High-tensile steel with solid steel castings at pivot areas
- Boom and stick stress-relieved after welding
- Catwalks with rails at boom
- Float valve for boom down function
- Buckets equipped with:
 - Special liner material covering main wear areas inside and outside
 - Lip shrouds
 - Wing shrouds
 - Heel shrouds

6020B Hydraulic Shovel Specifications

Dimensions

All dimensions are approximate.

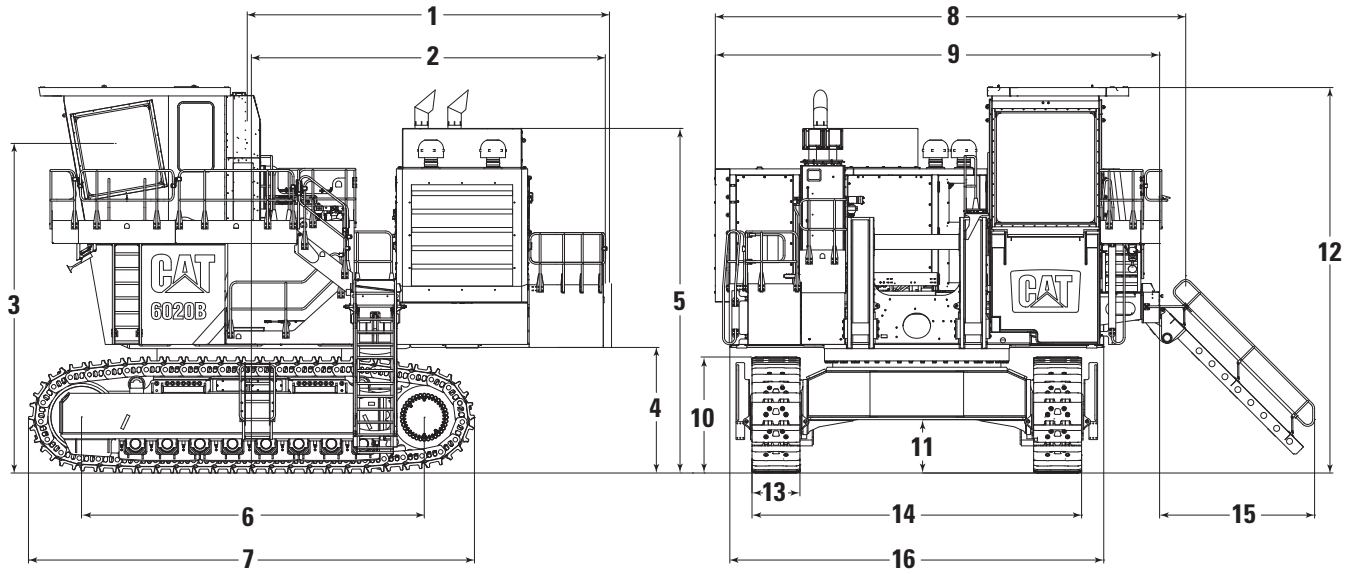

1	6045 mm	19 ft 10 in
2	5905 mm	19 ft 4 in
3	5450 mm	17 ft 11 in
4	2030 mm	6 ft 8 in
5	5680 mm	18 ft 8 in
6	5720 mm	18 ft 9 in
7	7445 mm	24 ft 5 in

8	7405 mm	24 ft 4 in
9	7405 mm	24 ft 4 in
10	1870 mm	6 ft 2 in
11	825 mm	2 ft 8 in
12	6370 mm	20 ft 11 in
13	800 mm	2 ft 7 in
14	5500 mm	18 ft 1 in
15	2400 mm	7 ft 10 in
16	6240 mm	20 ft 6 in

6020B Hydraulic Shovel Specifications

Backhoe Attachment (BH)

Working Diagram – Boom 8.7 m (28 ft 7 in) – Stick 3.9 m (12 ft 10 in)

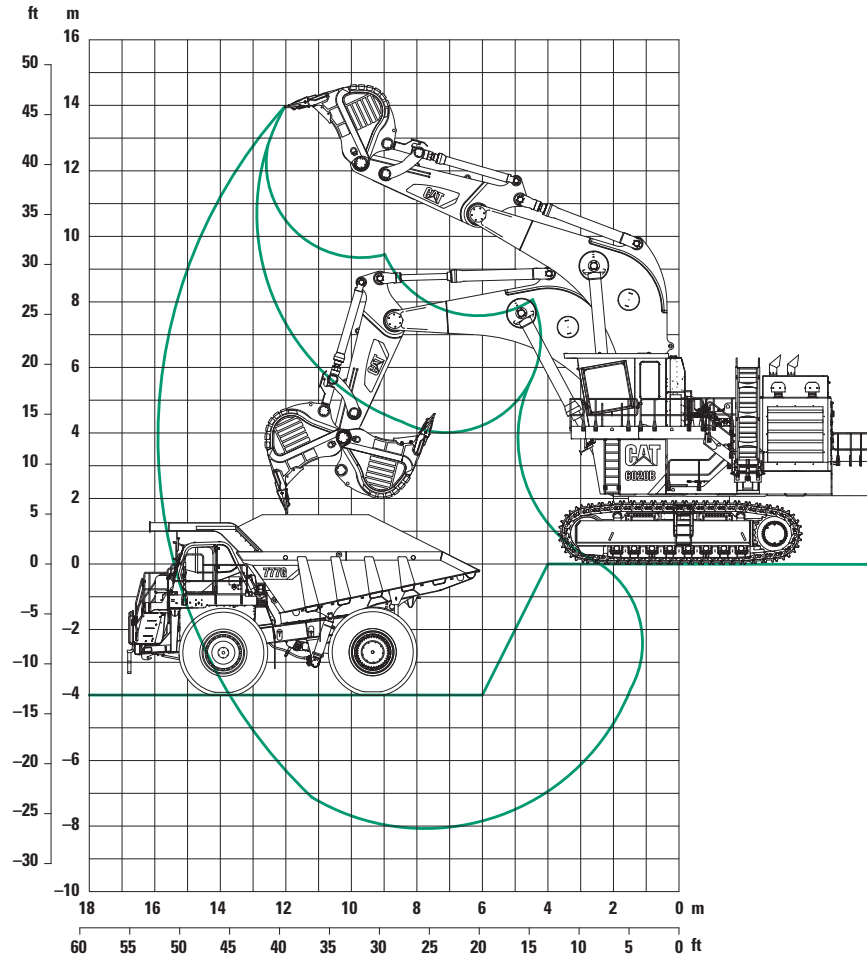

Working Range

Maximum Digging Depth	8.1 m	26 ft 7 in
Maximum Digging Reach	15.9 m	52 ft 2 in
Maximum Digging Height	13.9 m	45 ft 7 in

Digging Forces

Maximum Tearout Force	650 kN	146,125 lb
Maximum Breakout Force	730 kN	164,050 lb

Backhoes

Type	Standard rock bucket	
Tooth System	Cat C85 system	
Capacity 1:1	12.0 m ³	15.7 yd ³
Capacity 2:1	10.6 m ³	13.8 yd ³
Capacity Struck	9.2 m ³	12 yd ³
Total Width	3450 mm	14 ft 6 in
Inner Width	3000 mm	9 ft 10 in
No. of Teeth	6	
Weight including standard wear package	12 800 kg	28,220 lb
Maximum Material Density (loose)	1.8 t/m ³	3,030 lb/yd ³

Optional Equipment

Optional equipment may vary. Consult your Cat dealer for details.

SUPERSTRUCTURE

- Cold-weather package

CAB

- Redundant HVAC system
- Camera system
- Cat MineStar ready (Health, Fleet, Terrain, and Detect)

UNDERCARRIAGE

- Rough terrain undercarriage protection kit including belly plate and rear plumbing guard

ATTACHMENT

- Work lights on boom

BUCKETS

- 12.0 m³ (15.7 yd³) backhoe with abrasive wear package for 1.8 t/m³ (3,030 lb/yd³) density
- Additional buckets available, based on application, through your local Cat dealer

For more complete information on Cat products, dealer services, and industry solutions, visit us on the web at www.cat.com

AEHQ7364-02 (03-2015)
Replaces AEHQ7364-01

© 2015 Caterpillar
All rights reserved

Materials and specifications are subject to change without notice. Featured machines in photos may include additional equipment. See your Cat dealer for available options.

CAT, CATERPILLAR, SAFETY.CAT.COM, their respective logos, "Caterpillar Yellow" and the "Power Edge" trade dress, as well as corporate and product identity used herein, are trademarks of Caterpillar and may not be used without permission.

