

966M/972M

Wheel Loaders



	966M	972M
Engine Model	Cat® C9.3 ACERT™	Cat C9.3 ACERT
Maximum Power – ISO 14396	229 kW (311 hp metric)	247 kW (336 hp metric)
Maximum Net Power – ISO 9249	206 kW (280 hp metric)	223 kW (303 hp metric)
Bucket Capacities	2.5-9.2 m ³	2.9-9.9 m ³
Operating Weight	23 220 kg	24 897 kg

RELIABLE, PRODUCTIVE AND FUEL EFFICIENT

- 10% more fuel efficient than the industry leading K Series*
- Up to 25% more fuel efficient than H Series*
- **Performance Series buckets** are easy to load and improve material retention
- **Cat Fusion™ coupler system and work tools** provide a wide range of work tools and allow the same work tool on different sizes of wheel loaders
- **Cat engine with ACERT Technology** which meets EU Stage IV emission standards and includes Cat Clean Emissions Module for continuous and efficient operation
- **Advanced powershift transmission** with a standard lock up clutch torque converter and lock-to-lock shifting delivers smooth shifts, fast acceleration and speed on grade
- **Next generation axle** with standard on-the-go disc-type front manual differential locks to provide optimal traction in varying underfoot conditions for improved productivity
- **Next generation load-sensing hydraulic system** to provide optimal control of machine functions

EASE OF OPERATION

- **Best-in-class operator environment** for unmatched operator comfort and efficiency
- **Advanced technology with Cat Connect** to monitor, manage and enhance job site operations

SERVICE ACCESS

- *Legacy one-piece hood, centralized service centers, windshield cleaning platform and harness tie-off to provide the best in class service access*

Contents

Reliable4

Durable5

Productive6

Fuel Efficient7

Easy to Operate8

Versatile.....10

Integrated Technologies.....12

Owning Costs.....14

Operating Costs.....15

Serviceable.....16

Sustainable17

Customer Support.....17

Specifications.....18

Standard Equipment.....32

Optional Equipment.....33

Notes.....34



**Fuel efficiency is measured in mass of material moved per volume of fuel burned. Average efficiency improvement as tested and analyzed for an average composite cycle and standard configuration with variations per comparable model with and without Economy Mode active. Factors influence result variation such as, but not limited to, machine configuration, operator technique, machine application, climate, etc.*



The new 966M and 972M Wheel Loaders have an EU Stage IV ACERT engine equipped with a combination of proven electronic, fuel, air and aftertreatment components. Applying proven technologies systematically and strategically lets us meet our customer's high expectations for productivity and fuel efficiency. Deep system integration results in reduced emissions, improved performance and improved fuel economy without interrupting machine performance making it seamless to operators. The reliability, durability, and versatility of both the 966M and 972M result in machines that are better built to meet your needs.



Reliable

Proven Components and Technology You Can Count On.

Every EU Stage IV ACERT engine is equipped with a combination of proven electronic, fuel, air and aftertreatment components.

More Powerful, Reliable Engine Electronics

The electronics used in Cat EU Stage IV engines are more powerful and robust than ever. Increased features and connection commonality improve the customer experience and increase quality and reliability. Over-foam wiring harness adds to reliability even in the most demanding applications.

Hydraulics

The 966M and 972M hydraulic systems have significant design changes and customer value improvements. The main hydraulic valve is now a mono-block with an integrated ride control section. The mono-block design reduces weight, has forty percent fewer leak points and is common across all M Series models. Auxiliary third and fourth hydraulic functions can be easily added at the factory or in the field with the addition of a second remote valve.

Equipment Monitoring

Cat Connect technologies and Cat dealer services take the guesswork out of equipment management. Product Link™ and the online VisionLink® application enable you to monitor real-time machine data and manage machines health. Your Cat dealer offers expert advice and S-O-SSM Services to maintain equipment reliability and efficiency.

Cold Start Package

The new optional cold start package provides dependable starts in extreme cold weather and high altitudes.



Durable

Better Built to Meet Your Needs.

Frames

The robotically welded two-piece structural frame design provides strong and rigid structures that absorb all the forces associated to penetration, loading and twisting.

The M Series articulating hitch system, joining the front and rear frames, provides increased bearing force capacity.

Axles

The M Series axles are designed to handle extreme applications resulting in reliable performance and durable life. The rear axle can oscillate to ± 13 degrees helping to ensure all four wheels stay on the ground providing stability even in the roughest terrain, for excellent stability and traction.

Productive

Work Smart and Move More.



The right technologies fine-tuned for the right applications result in:

- **Improved Fluid Efficiency** – Up to 5% improvement over EU Stage IIIB products (including Diesel Exhaust Fluid consumption).
- **High Performance** across a variety of applications.
- **Enhanced Reliability** through commonality and simplicity of design.
- **Maximized Uptime and Reduced Cost** with world-class support from the Cat dealer network.
- **Minimized Impact of Emission Systems** – Designed to be transparent to the operator without requiring interaction.
- **Durable Designs** with long life to overhaul.
- **Delivering Better Fuel Economy** with minimized maintenance costs while providing the same great power and response.

Hydraulics

The new ride control system now has two accumulators enabling it to be more effective over a greater payload range, increasing productivity and operator efficiency due to a better ride.

The next generation implement pump continuously and automatically balance hydraulic loads with the machine performance desired by the operator. Engine response is improved as is performance at higher altitudes.

Transmission

The 966M and 972M power trains have been improved with the addition of a lock-up clutch torque converter standard. These new torque converters have been matched with the engine power and hydraulics to improve performance and fuel efficiency. These rugged planetary transmissions also have a new split-flow oil system which use new multi-viscosity oil to improve fuel economy.

Axles

In addition to aggregates, sand and gravel and batch plants, these models are commonly used in heavy construction applications where poor underfoot conditions make traction difficult slowing production and challenging job deadlines. The new on-the-fly disc-type differential locks will improve tractive ability in these applications thereby increasing productivity. These models come standard with front axle differential locks which are manually activated by a switch on the floor. Optional fully automatic front and rear axle differential locks operate by measuring differences in wheel speeds and require no operator intervention to activate. These disc-type differential locks reduce tire scuffing compared to other traction aids further reducing operating costs for customers.

The axles have new external caliper disc parking brakes mounted to the input shaft of the front axles. Since they are external, they do not have the inefficiencies of enclosed wet parking brakes due to brake discs running in oil nor is there any oil to change reducing fuel and maintenance costs. External caliper parking brakes are easily accessible for inspection and service.

Fuel Efficient

Engineered to Lower Your Operating Costs.

Engine and Emissions

The Cat C9.3 ACERT engine is designed for maximum fuel efficiency and increased power density, while meeting EU Stage IV emission standards. This engine features innovative Cat electronics, fuel injection process, air-management systems, aftertreatment solution with Cat Selective Catalytic Reduction, and a fuel efficient regeneration system. The Cat Regeneration System automatically removes soot from the Diesel Particulate Filter without interrupting your machine's work cycle.

Advanced Systems with Innovative Integration

The deep system integration of the new engine and emissions system, power train, hydraulic system and cooling system intelligently lower the average working engine speeds and reduce the overall system heat loads which result in significantly increased performance and fuel efficiency. The new 966M and 972M are 10% more fuel efficient on average compared to the 966K and 972K, they are second only to the 966M XE and 972M XE which are the class leaders in fuel efficiency.

Economy Mode

The productive economy mode automatically controls the engine torque and speed based on the machine's power train load and places engine speed and torque in the most efficient operating range. The result is a further reduction of the fuel consumption while delivering performance similar to K Series.



Next Generation Fuel Systems

Cat injection timing precisely controls the fuel injection process through a series of carefully timed microbursts, providing more control of combustion for the cleanest, most efficient fuel burn. On 966M and 972M the High-Pressure Common Rail Fuel Systems boost performance and reduce soot for the C9.3 ACERT engine.

Cat NO_x Reduction System

The Cat NO_x Reduction System (NRS) captures and cools a small quantity of exhaust gas, then routes it back into the combustion chamber where it drives down combustion temperatures and reduces NO_x emissions.

Aftertreatment Technologies

To meet the additional 80% reduction in NO_x emissions required by EU Stage IV emission standards, one new system, the Selective Catalytic Reduction (SCR), has been added to the already proven Cat EU Stage IIIB aftertreatment solution.

Easy to Operate

Safe. Comfortable. Efficient.



Improving operator efficiency remains a key design goal for the 966M, 966M XE, 972M and 972M XE. Ensuring operators are safe, confident in the control of their machines, have a clean, comfortable and quiet operating environment with controls that are intuitive and low effort all contribute to lower operator fatigue and better performance.

Cab Access

A switch has been added to the electronic service center which unlatches the door remotely (optional). The gas strut then swings the door open all while the operator is safely on the ground. The angle of the steps up to the cab has been increased to an optimal fifteen degrees enabling operators to walk up like stairs versus climbing more vertically like a ladder. Grab handles have been repositioned so a secure three points of contact can be maintained at all times.



Visibility

Once in the cab, the new door securely seals against the new roll formed ROPS posts and the lower glass panel has been extended several inches to improve visibility to the left side of the machine. New larger convex mirrors improve visibility to the rear and integrated spot mirrors provide visibility close to both sides of the machine.

Sound and Vibration

The Cat air suspended seat, the viscous cab mount combined with lower engine speeds and an improved ride control system decrease noise and vibration the operator is subjected too, allowing him to remain efficient and productive the whole day long.

Central Display

The central display panel has a large text box, five analog gauges, and LED warning indicators. The large text box provides in-language information about machine operation, feature activation and system troubleshooting and calibration. With the five large analog gauges the operator can easily identify if key systems are within normal operating range.



Touch Screen Display

A new multipurpose color touch screen display dramatically simplifies the operator interface; with machine controls, rear vision camera and new fully integrated Cat Production Measurement system. Intuitive navigation with in-language text enables operators to modify certain machine operating parameters and monitor machine conditions literally at the touch of their fingers.

Control Panel

Sealed against moisture and dirt, the centralized switch panel with LED's provides reliability and ready access to frequently required functions, even while wearing gloves. The ISO symbols located on each membrane switch are molded all the way through to ensure the image will not wear off over time.

The M Series maintains the "help" feature which explains the function of each membrane switch.

Focusing on operator efficiency, the control panel has been streamlined to include easy to reach highly utilized machine controls. The touch screen display enables the relocation of some expanded functions while eliminating the need for a second switch panel for further simplicity and easy machine operation.



Electro-Hydraulic (EH) Joystick Steering with Force Feedback (Speed Sensitive)

Your operators will enjoy and quickly adapt to the industry leading seat mounted EH joystick steering system, which provides precision control and dramatically decreases operator arm fatigue. For operators who prefer a steering wheel, an electro-hydraulic steering wheel is available as an option.

Implement Controls (EH)

Seat mounted implement controls provide your operator with precise control of the work tool, all while moving with the seat for maximum comfort. In-cab programmable kick-outs and automatic cylinder snubbing are easy to set on-the-go for tilt, lower and lift, ideal for repeatable cycles.



Ride Control

The next generation of ride control works as a shock absorber, improving ride quality and smoothness over rough terrain, increasing your operator confidence, comfort and efficiency, ensuring excellent material retention.

Versatile

Linkage and Guard Options to Meet Your Various Applications Needs.



Standard Z-bar Linkage

The proven Z-bar linkage combines digging efficiency with excellent visibility to the tool resulting in excellent penetration into the pile, high breakout forces and superior production capabilities.

High Lift Linkage

The optional high lift linkage offers increased hinge pin height to load more easily in a variety of applications with any type of bucket or fork.

Aggregate Handler

Aggregate packages are specialized offerings for specific loose aggregate rehandling applications, such as truck loading, hopper charging, stockpiling, and load and carry. Rehandling loose aggregate is less stressful to the machine, therefore payloads can be increased above other applications by installing larger buckets, counterweights and a scale system such as the Cat Production Measurement system.

To do so, the Cat aggregate packages require some prerequisites in terms of correct application, machine configuration and conformance to Caterpillar payload policy. Misapplication of Aggregate Handlers may result in significant reliability and durability risk.

Industrial and Waste Handler

The Industrial and Waste Packages offer integrated guards to preserve your machine from the harsh environment of a scrap or waste handling application. The machine guarding is purpose built to protect your machine's major components and systems to ensure durability and reliability.



Versatile

Do More Jobs with One Machine, Fusion Quick Coupler and Various Work Tools.

An extensive range of work tools and bucket styles are available to customize these machines for your operation. Work tools are available either with pin on or quick coupler interface.

Performance Series Buckets

- **Load Easy, Fuel Efficient, Carry More** – Performance Series Buckets utilize a system-based approach to balance bucket shape with the machine’s linkage, weight, lift and tilt capacities. Operators benefit from reduced dig times and better material retention; ultimately translating into significant productivity and fuel efficiency improvements.
- **Lower Operating Costs** – Performance Series Buckets feature a longer floor that easily digs through the pile and provides excellent visibility for the operators to see when the bucket is full. Less time digging in the pile results in lower fuel consumption and improved tire life. A unique spill guard protects the cab and linkage components from material overflow.
- **Higher Productivity** – Performance Series Buckets achieve higher fill factors – ranging from 100% to 115% depending on the machine application and material type. The buckets feature a curved side profile to maximize material retention. The optimized design results in unsurpassed production capabilities.

Fusion Quick Coupler

Improved Machine Performance

Fusion is the patented wheel loader coupler system from Caterpillar. The Fusion Coupler System provides performance virtually identical to pin on – with all the flexibility of a quick coupler system. The Fusion Coupler sits back, close in to the loader arms – minimizing offset and increasing the machine’s performance.

No Loss of Performance

Fusion is designed to integrate the work tool and the machine by pulling the coupler and tool closer in to the loader. As a result, the center of gravity is moved inward, towards the machine. This translates to increased lifting ability when compared to machines equipped with other coupler systems.

Unsurpassed Durability

An advanced wedging mechanism creates a tight, rattle-free fit. This patented lock up system eliminates play and wear – resulting in a long service life.

Increased Visibility

A new, open coupler frame design clears sight lines from the operator’s seat, making it easier than ever before to engage and disengage attachments with certainty.

Common Interface Compatibility

The Fusion Coupler System not only allows one machine to use a range of work tools, but also allows one work tool to be picked up by machines of many different sizes.

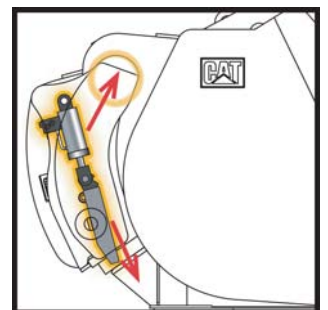
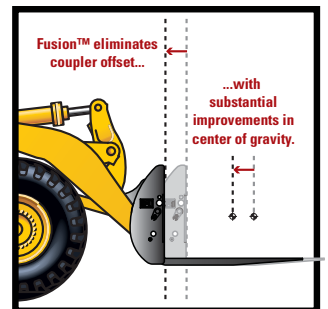





Integrated Technologies

Monitor, Manage, and Enhance Job Site Operations.

Cat Connect makes smart use of technology and services to improve your job site efficiency. Using the data from technology-equipped machines, you'll get more information and insight into your equipment and operations than ever before.

Cat Connect technologies offer improvements in these key areas:

- 
EQUIPMENT MANAGEMENT
Equipment Management – increase uptime and reduce operating costs.
- 
PRODUCTIVITY
Productivity – monitor production and manage job site efficiency.
- 
SAFETY
Safety – enhance job site awareness to keep your people and equipment safe.

Featured Cat Connect technologies include:

Cat Connect LINK Technologies

LINK technologies wirelessly connect you to your equipment giving you access to essential information you need to know to run your business. Link data can give you valuable insight into how your machine or fleet is performing so you can make timely, fact-based decisions that can boost job site efficiency and productivity.

Product Link/VisionLink

Product Link is deeply integrated into your machine to take the guesswork out of equipment management. Easy access to timely information like machine location, hours, fuel usage, idle time and event codes via the online VisionLink user interface can help you effectively manage your fleet and lower operating cost.



Cat Connect PAYLOAD Technologies

PAYLOAD technologies enable accurate weight measurement of material being loaded or hauled. Payload information is shared with loader operators in real-time to improve productivity, reduce overloading and record both weights and number of loads per shift.

Cat Production Measurement App

Cat Production Measurement provides on-the-go payload weighing through the standard touch-screen display so operators can deliver exact loads with confidence and work more efficiently. Caterpillar designed, fully integrated, and factory-fit for high accuracy, reliability and ease of use. Stores up to 20 material types and 50 truck IDs and records detailed data to track productivity, including time/date, weights, cycles, and more. An optional in-cab printer provides the driver a printed receipt of truck payloads.

The operator can track production using the two trip counter screens on the display. Site supervisors can wirelessly access data using the VisionLink web portal to measure production and monitor efficiency.



Cat Connect DETECT Technologies

DETECT technologies help keep people and equipment safe by enhancing operator awareness of the work area around the equipment, by integrating safety features and by monitoring and reporting unsafe conditions or equipment operation.

Rear Vision Camera

The standard rear vision camera greatly enhances visibility behind the machine to help the operator work more safely and productively. A panoramic rear view is automatically displayed on the new multi-function monitor during reverse travel. As an option, a second display can be added, providing a dedicated full-time rear view of the job site.



Owning Costs

Proven Best Investment.

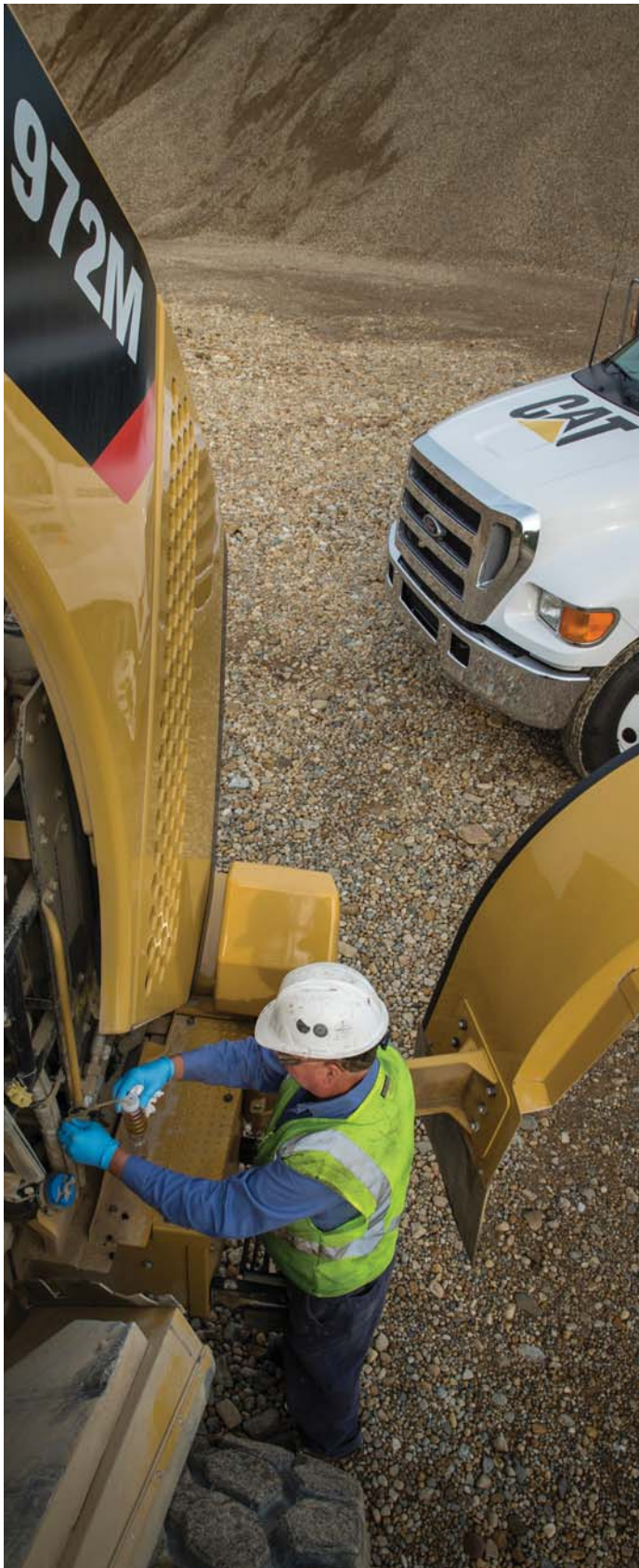

Customer Support Agreements

A Customer Support Agreement (CSA) is an arrangement between you and your Cat dealer that helps you lower your total cost per ton. CSAs are flexible, allowing them to be tailored to your business needs. They can range from simple Preventive Maintenance Kits to elaborate Total Cost Performance Guarantees. Having a CSA with your Cat dealer enables more time for you to do what you do best – run your business.

Monitoring Systems

Monitoring product health is key to optimizing the life of an investment into a Cat Wheel Loader.

- **Cat Product Link** – Cat Product Link allows remote monitoring of equipment to improve overall fleet management effectiveness. Product Link is deeply integrated into machine systems. Events and diagnostic codes, as well as hours, fuel, idle time and other detailed information are transmitted to a secure web based application, VisionLink. VisionLink includes powerful tools to convey information to users and dealers, including mapping, working and idle time, fuel level and more.
- **S-O-S Services** – Helps manage component life and decrease machine downtime, increasing productivity and efficiency. Regular fluid sampling can help track what is going on inside your machine. Wear related problems are predictable and easily repairable. Maintenance can be done to accommodate your schedule, resulting in increased uptime and flexibility in maintenance repairs before failure.

Parts Availability

Caterpillar provides an unsurpassed level of personalized service to help you work more cost effectively and efficiently. By utilizing a worldwide parts network Cat dealers help minimize machine downtime and save money by delivering replacement parts within 24 hours.

Resale Value

Owning quality equipment is an important factor in maintaining resale value. Caterpillar is not only known for machines that are better built, but provides product and dealer support to maintain the reliability and durability of your machine.



Operating Costs

Save Time and Money by Working Smart.

Machine configuration, operator technique, and job site layout can impact fuel consumption by as much as 30 percent. Data from customer machines show Cat wheel loaders are the most fuel efficient machines in the industry. Several features contribute to this excellent fuel efficiency:

- **New M Series EU Stage IV Engine, Hydraulics, Transmission and Ride Control** – Deep system integration results in reduced emissions, more productivity, lower fuel consumption, without interrupting machine performance. Further savings in fuel consumption can be achieved by activation of the **Economy Mode** (a green leaf appears in the display) and of the **Automatic Idle Engine Shutdown System**.
- **New Manual/Automatic Differential Locks** – Increase traction, reduce tire scuffing compared to other traction aids, further reducing your operating costs.
- **New External Caliper Disc Parking Brakes** – Easily accessible for maintenance.
- **Lock-up-Clutch Torque Converter and Shift Strategy** – Reduced torque interruption increases driveline efficiency, conserving fuel. Auto 1-4 transmission mode keeps engine rpm low, reducing fuel consumption while delivering optimal machine performance.
- **Machine Configuration** – Select the correct linkage, guarding, work tool and tire type based on machine application. Radial tires are preferred; ensure proper inflation pressures. Heavier tires burn more fuel.
- **Performance Series Buckets** – Deliver faster fill times and better material retention, ultimately reducing cycle times while improving productivity and fuel efficiency.

Enabling Application Efficiency

- **Loading Bucket** – Load in first gear and keep engine rpm low. Raise and tilt bucket smoother, with Caterpillar's multi-function capability, and do not use a "pumping" motion. Avoid lift lever detent and use of transmission neutralizer. Use programmable kick-outs and automatic cylinder snubbing during repeated cycles.
- **Loading Truck or Hopper** – Do not raise the work tool any higher than necessary. Keep engine rpm low and unload in controlled manner.
- **Idle** – Set the parking brake to engage Engine Idle Management System to conserve fuel.
- **Job Site Layout** – Spot loading targets in the right position. Avoid traveling more than twice the machine length during short cycle loading. Reduce transport distance for load and carry cycles by optimizing job site layout.

Serviceable

Easy to Maintain. Easy to Service.

Engine Access ①

The Cat sloped “one-piece” tilting hood provides industry leading access to the engine. Its design has further been improved on all M Series wheel loaders to provide the best-in-class service access to engine, oil levels and coolant sight gauge.

Cooling System ②

The cooling system is readily accessible for clean out and maintenance. With six cooling fins per 25.4 mm and a perforated grill, most airborne debris entering the system passes through the cooler cores. The hydraulic and A/C cooler cores swing out providing easy access to both sides for cleaning. An access panel on the left side of the cooling package swings down to provide access to the back side of the engine coolant and Air-to-Air After Cooler (ATAAC). An optional variable pitch fan can automatically purge the cooler cores by periodically reversing the airflow when needed.

Service Centers

The electrical ④ and hydraulic ③ service centers provide grouped ground level access to numerous features, enhancing safety and convenience for your operators and service technicians, while reducing service time.

The electrical service center, located beneath the left platform, contains the maintenance free batteries, a fuse relay panel, main disconnect switch, ground level engine shutdown switch, hood tilt switch, and the jump start receptacle.

The hydraulic service centers are now virtually identical for the M Series product line. This new consistent layout makes it easier for service technicians who work on a variety of M Series models.

Hydraulic system components on the 966M, 966M XE, 972M and 972M XE are protected by full flow and kidney-loop filtration. A filter in the hydraulic tank return line filters all of the oil returning to the tank. There is also a case drain screen for additional protection and finally, a separate kidney-loop filter with a finer micron rating continuously filters smaller particles out of the system. This multilevel design ensures the hydraulic oil is clean and thoroughly protects the rest of the hydraulic system from contamination. A new thermal bypass valve has been added to improve hydraulic system warm-up.

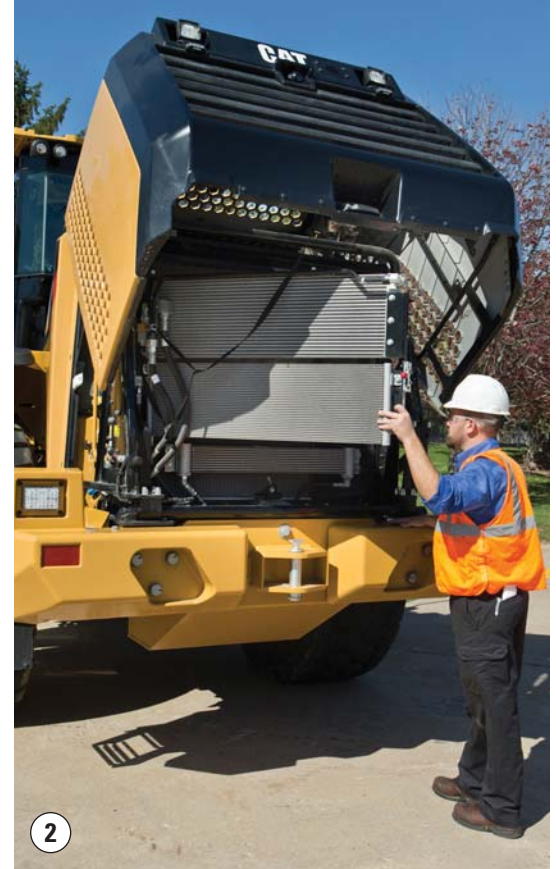

Sustainable Conserving Resources.

The 966M and 972M are designed to compliment your business plan, reduce emissions and minimize the consumption of natural resources.

- Improved fuel efficiency – less fuel consumed results in lower emissions.
- Machines are built with a 97% recyclability rate (ISO 16714) to conserve valuable natural resources and further enhance machine end of life value.
- Improved operator efficiency through enhanced visibility and reduced noise levels.
- Link technologies enable you to collect and analyze equipment and job site data so you can maximize productivity and reduce costs.
- Major components are rebuildable, eliminating waste and saving money by giving the machine and/or major components a second life – and even a third life.



Customer Support Unmatched Support Makes the Difference.



Renowned Cat Dealer Support

- Your Cat dealer is ready to help you every step of the way. From new or used machine sales, to rental or rebuild options, your Cat dealer can provide an optimal solution to your business needs.
- Unsurpassed worldwide parts availability, trained technicians and customer support agreements maximize your machine uptime.
- Financing options are offered to meet a variety of customer needs.

966M/972M Wheel Loaders Specifications

Engine – 966M

Engine Model	Cat C9.3 ACERT
Maximum Gross Power (1,800 rpm)	
SAE J1995	232 kW (315 hp metric)
Maximum Power (1,800 rpm)	
ISO 14396	229 kW (311 hp metric)
Maximum Net Power (1,700 rpm)	
ISO 9249	206 kW (280 hp metric)
Peak Gross Torque (1,200 rpm)	
SAE J1995	1599 N·m
Peak Torque (1,200 rpm)	
ISO 14396	1581 N·m
Maximum Net Torque (1,000 rpm)	
ISO 9249	1527 N·m
Bore	115 mm
Stroke	149 mm
Displacement	9.3 L

- Cat engine with ACERT Technology – meets EU Stage IV emission standards.
- The power ratings apply at the stated speed when tested under the reference conditions for the specified standards.
- The net power advertised is the power available at the flywheel when the engine is equipped with fan, alternator, air cleaner and aftertreatment.
- The gross power advertised is with the fan at maximum speed.

Buckets – 966M

Bucket Capacities	2.5-9.2 m ³
-------------------	------------------------

Weight – 966M

Operating Weight	23 220 kg
------------------	-----------

- Weight based on a machine configuration with Michelin 26.5R25 XHA2 L3 radial tires, full fluids, operator, standard counterweight, cold start, roading fenders, Product Link, manual diff lock/open axles (front/rear), power train guard, secondary steering, sound suppression and a 4.2 m³ general purpose bucket with BOCE.

Operating Specifications – 966M

Static Tipping Load – Full 37° Turn	
With Tire Deflection	14 668 kg
No Tire Deflection	15 822 kg
Breakout Force	173 kN

- For a machine configuration as defined under “Weight.”
- Full compliance to ISO 143971:2007 Sections 1 thru 6, which requires 2% verification between calculations and testing.

Engine – 972M

Engine Model	Cat C9.3 ACERT
Maximum Gross Power (1,800 rpm)	
SAE J1995	251 kW (341 hp metric)
Maximum Power (1,800 rpm)	
ISO 14396	247 kW (336 hp metric)
Maximum Net Power (1,700 rpm)	
ISO 9249	223 kW (303 hp metric)
Peak Gross Torque (1,200 rpm)	
SAE J1995	1728 N·m
Peak Torque (1,200 rpm)	
ISO 14396	1710 N·m
Maximum Net Torque (1,000 rpm)	
ISO 9249	1654 N·m
Bore	115 mm
Stroke	149 mm
Displacement	9.3 L

- Cat engine with ACERT Technology – meets EU Stage IV emission standards.
- The power ratings apply at the stated speed when tested under the reference conditions for the specified standards.
- The net power advertised is the power available at the flywheel when the engine is equipped with fan, alternator, air cleaner and aftertreatment.
- The gross power advertised is with the fan at maximum speed.

Buckets – 972M

Bucket Capacities	2.9-9.9 m ³
-------------------	------------------------

Weight – 972M

Operating Weight	24 897 kg
------------------	-----------

- Weight based on a machine configuration with Michelin 26.5R25 XHA2 L3 radial tires, full fluids, operator, standard counterweight, cold start, roading fenders, Product Link, manual diff lock/open axles (front/rear), power train guard, secondary steering, sound suppression and a 4.8 m³ general purpose bucket with BOCE.

Operating Specifications – 972M

Static Tipping Load – Full 37° Turn	
With Tire Deflection	16 164 kg
No Tire Deflection	17 421 kg
Breakout Force	196 kN

- For a machine configuration as defined under “Weight.”
- Full compliance to ISO 143971:2007 Sections 1 thru 6, which requires 2% verification between calculations and testing.

966M/972M Wheel Loaders Specifications

Brakes

Brakes	Brakes meet ISO 3450 standards
--------	--------------------------------

Transmission

Forward 1	6.5 km/h
Forward 2	13.0 km/h
Forward 3	23.5 km/h
Forward 4	40.0 km/h
Reverse 1	7.1 km/h
Reverse 2	14.4 km/h
Reverse 3	25.9 km/h
Reverse 4	39.0 km/h

- Maximum travel speed in standard vehicle with empty bucket and standard L3 tires with 826 mm roll radius.

Hydraulic System

Implement Pump Type	Variable Displacement Piston	
Implement System		
Maximum Pump Output (2,200 rpm)	360 L/min	
Maximum Operating Pressure	31 000 kPa	
Maximum Flow – Optional 3 rd /4 th Function	260 L/min	
Maximum Pressure – Optional 3 rd /4 th Function	20 680 kPa	
Hydraulic Cycle Time with Rated Payload	966M	972M
Raise from Carry Position	6.1 Sec.	6.1 Sec.
Dump, at Maximum Raise	1.4 Sec.	1.5 Sec.
Lower, Empty, Float Down	2.8 Sec.	3.1 Sec.
Total	10.3 Sec.	10.7 Sec.

Axles

Front	Fixed
Rear	Oscillating ±13 degrees
Maximum Single-Wheel Rise and Fall	502 mm

Cab

ROPS/FOPS	ROPS/FOPS meet ISO 3471 and ISO 3449 Level II standards
-----------	---

Sound

- The sound values indicated below are for specific operating conditions only. Machine and operator sound levels will vary at different engine and/or cooling fan speeds. Hearing protection may be needed when the machine is operated with a cabin that is not properly maintained, or when the doors and/or windows are open for extended periods or in a noisy environment.

Exterior Sound Power Level (ISO 6395:2008)	108 L _{WA} *
--	-----------------------

- *The exterior sound power level that is labeled on the machine is obtained according to the test procedures and conditions that are specified in the European Union Directive “2000/14/EC” as amended by “2005/88/EC,” with the cooling fan speed set at 70% of maximum value.

Service Refill Capacities

Fuel Tank	313 L
DEF Tank	16.8 L
Cooling System	71.6 L
Crankcase	24.5 L
Transmission	58.5 L
Differentials and Final Drives – Front	57 L
Differentials and Final Drives – Rear	57 L
Hydraulic Tank	125 L

966M/972M Wheel Loaders Specifications

966M Dimensions

All dimensions are approximate.

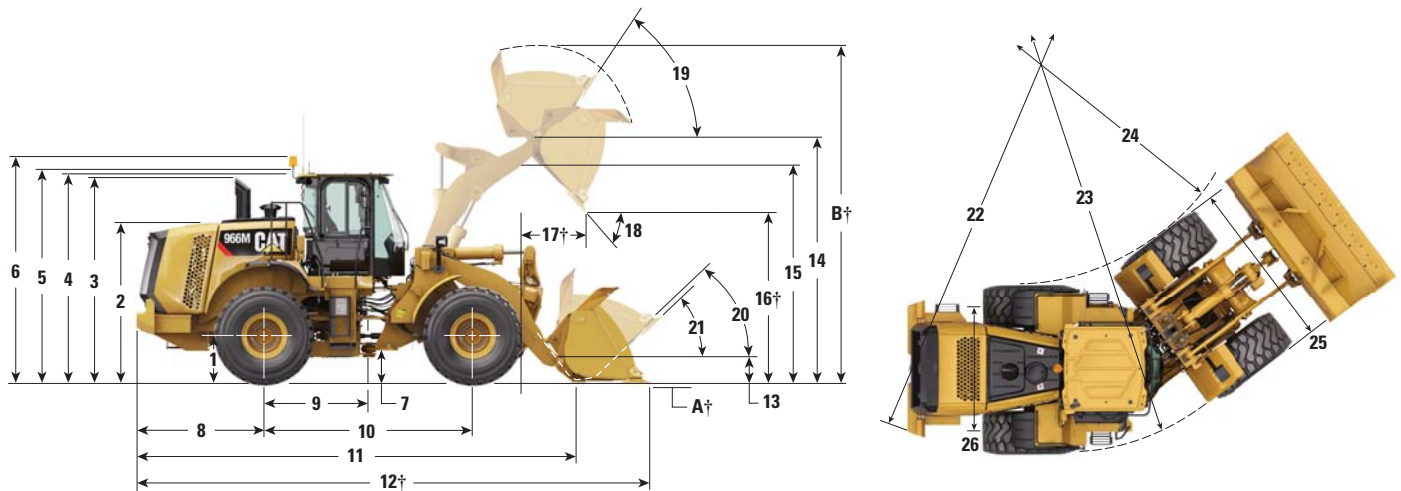

	Standard Lift	High Lift
1 Height to Axle Centerline	799 mm	799 mm
2 Height to Top of Hood	2818 mm	2818 mm
3 Height to Top of Exhaust Pipe	3522 mm	3522 mm
4 Height to Top of ROPS	3559 mm	3559 mm
5 Height to Top of Product Link Antenna	3582 mm	3582 mm
6 Height to Top of Warning Beacon	3810 mm	3810 mm
7 Ground Clearance	476 mm	476 mm
8 Center Line of Rear Axle to Edge of Counterweight	2180 mm	2500 mm
9 Center Line of Rear Axle to Hitch	1775 mm	1775 mm
10 Wheelbase	3550 mm	3550 mm
11 Overall Length (without bucket)	7289 mm	8109 mm
12 Shipping Length (with bucket level on ground)*†	8750 mm	9570 mm
13 Hinge Pin Height at Carry Height	630 mm	778 mm
14 Hinge Pin Height at Maximum Lift	4235 mm	4793 mm
15 Lift Arm Clearance at Maximum Lift	3643 mm	4140 mm
16 Dump Clearance at Maximum Lift and 45° Discharge*†	2991 mm	3549 mm
17 Reach at Maximum Lift and 45° Discharge*†	1353 mm	1328 mm
18 Dump Angle at Maximum Lift and Dump (on stops)*	49 degrees	48 degrees
19 Rack Back at Maximum Lift*	62 degrees	71 degrees
20 Rack Back at Carry Height*	50 degrees	49 degrees
21 Rack Back at Ground*	42 degrees	39 degrees
22 Clearance Circle (dia) to Counterweight	13 608 mm	13 608 mm
23 Clearance Circle (dia) to Outside of Tires	13 522 mm	13 522 mm
24 Clearance Circle (dia) to Inside of Tires	7706 mm	7706 mm
25 Maximum Width over Tires (unloaded)	2991 mm	2991 mm
Maximum Width over Tires (loaded)	3009 mm	3009 mm
26 Tread Width	2230 mm	2230 mm

*With 4.2 m³ general purpose pin on bucket with BOCE (see Operating Specifications for other buckets).

†Dimensions are listed in Operating Specification charts.

All height and tire related dimensions are with Michelin 26.5R25 XHA2 L3 tires (see Dimension changes – Tires Chart for other tires).

966M/972M Wheel Loaders Specifications

972M Dimensions

All dimensions are approximate.

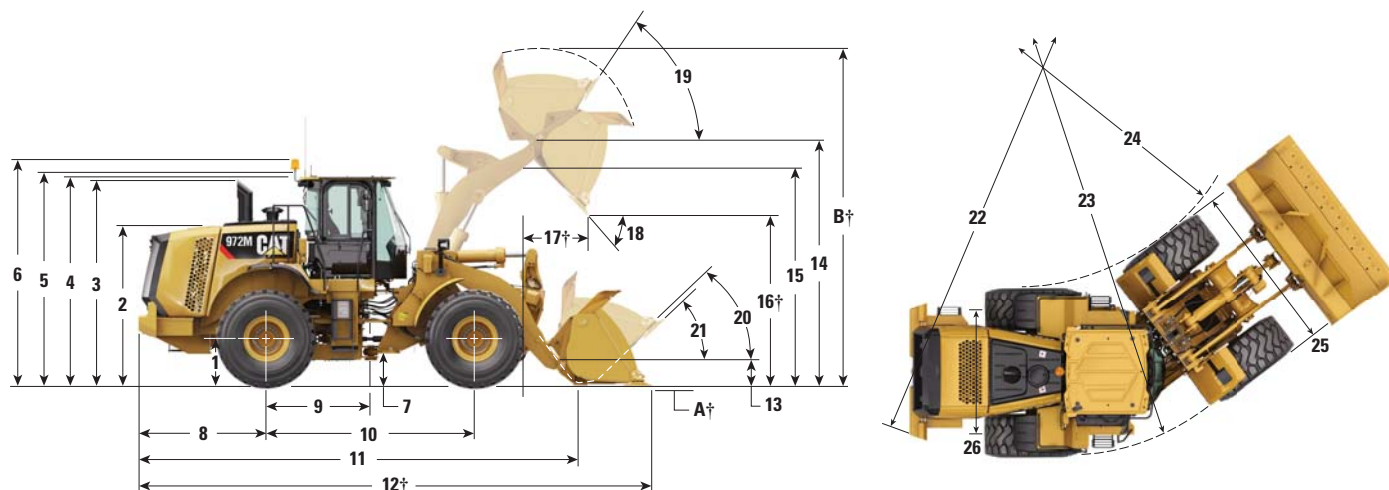

	Standard Lift	High Lift	Extended Capacity
1 Height to Axle Centerline	799 mm	799 mm	799 mm
2 Height to Top of Hood	2818 mm	2818 mm	2818 mm
3 Height to Top of Exhaust Pipe	3522 mm	3522 mm	3522 mm
4 Height to Top of ROPS	3559 mm	3559 mm	3559 mm
5 Height to Top of Product Link Antenna	3582 mm	3582 mm	3582 mm
6 Height to Top of Warning Beacon	3810 mm	3810 mm	3810 mm
7 Ground Clearance	476 mm	476 mm	476 mm
8 Center Line of Rear Axle to Edge of Counterweight	2500 mm	2500 mm	2500 mm
9 Center Line of Rear Axle to Hitch	1775 mm	1775 mm	1775 mm
10 Wheelbase	3550 mm	3550 mm	3550 mm
11 Overall Length (without bucket)	7774 mm	8109 mm	7609 mm
12 Shipping Length (with bucket level on ground)*†	9315 mm	9650 mm	9164 mm
13 Hinge Pin Height at Carry Height	680 mm	778 mm	631 mm
14 Hinge Pin Height at Maximum Lift	4458 mm	4793 mm	4235 mm
15 Lift Arm Clearance at Maximum Lift	3843 mm	4140 mm	3643 mm
16 Dump Clearance at Maximum Lift and 45° Discharge*†	3154 mm	3490 mm	2920 mm
17 Reach at Maximum Lift and 45° Discharge*†	1357 mm	1380 mm	1413 mm
18 Dump Angle at Maximum Lift and Dump (on stops)*	48 degrees	48 degrees	48 degrees
19 Rack Back at Maximum Lift*	56 degrees	71 degrees	62 degrees
20 Rack Back at Carry Height*	50 degrees	49 degrees	50 degrees
21 Rack Back at Ground*	41 degrees	39 degrees	42 degrees
22 Clearance Circle (dia) to Counterweight	13 608 mm	13 608 mm	13 608 mm
23 Clearance Circle (dia) to Outside of Tires	13 522 mm	13 522 mm	13 522 mm
24 Clearance Circle (dia) to Inside of Tires	7706 mm	7706 mm	7706 mm
25 Maximum Width over Tires (unloaded)	2991 mm	2991 mm	2991 mm
Maximum Width over Tires (loaded)	3009 mm	3009 mm	3009 mm
26 Tread Width	2230 mm	2230 mm	2230 mm

*Standard and High Lift are with 4.8 m³ general purpose pin on bucket with BOCE (see Operating Specifications for other buckets).

Extended Capacity is with a 4.9 m³ general purpose pin on bucket with BOCE (see Operating Specifications for other buckets).

†Dimensions are listed in Operating Specification charts.

All height and tire related dimensions are with Michelin 26.5R25 XHA2 L3 tires (see Dimension changes – Tires Chart for other tires).

966M/972M Wheel Loaders Specifications

Dimension Changes – Tires

Tire Brand	Michelin	Michelin	Michelin	Bridgestone	Bridgestone
Tire Size	26.5R25	26.5R25	26.5R25	26.5R25	26.5R25
Tread Type	L-4	L-5	L-5	L-3	L-4
Tread Pattern	XLDD1	XLDD2	XMINED2	VJT	VSNT
Width over Tires – Maximum (empty)*	2987 mm	2986 mm	2970 mm	2982 mm	2973 mm
Width over Tires – Maximum (loaded)*	3019 mm	3011 mm	2994 mm	3016 mm	2993 mm
Change in Vertical Dimensions (average of front and rear)	44 mm	39 mm	53 mm	15 mm	25 mm
Change in Horizontal Reach	-36 mm	-34 mm	-32 mm	-3 mm	-24 mm
Change in Clearance Circle to Outside of Tires	10 mm	3 mm	-14 mm	7 mm	-16 mm
Change in Clearance Circle to Inside of Tires	-10 mm	-3 mm	14 mm	-7 mm	16 mm
Change in Operating Weight (without Ballast)	420 kg	716 kg	1068 kg	164 kg	624 kg

Changes Specific to the 966M

Change in Static Tipping Load – Straight	303 kg	517 kg	771 kg	118 kg	451 kg
Change in Static Tipping Load – Articulated	271 kg	461 kg	688 kg	106 kg	402 kg

Changes Specific to the 972M

Change in Static Tipping Load – Straight	283 kg	482 kg	719 kg	110 kg	420 kg
Change in Static Tipping Load – Articulated	252 kg	429 kg	640 kg	98 kg	374 kg

Dimension Changes – Tires

Tire Brand	Bridgestone	Bridgestone	Flexport	Flexport
Tire Size	26.5R25	775/65R29	70×14×28 (26.5×25)	70×14×28 (26.5×25)
Tread Type	L-5	L-3	—	—
Tread Pattern	VSDL	VTS	OTR	SMOOTH
Width over Tires – Maximum (empty)*	2874 mm	3050 mm	2955 mm	2896 mm
Width over Tires – Maximum (loaded)*	2900 mm	3071 mm	2972 mm	2915 mm
Change in Vertical Dimensions (average of front and rear)	50 mm	17 mm	59 mm	52 mm
Change in Horizontal Reach	-29 mm	-5 mm	-23 mm	-13 mm
Change in Clearance Circle to Outside of Tires	-109 mm	62 mm	-37 mm	-94 mm
Change in Clearance Circle to Inside of Tires	109 mm	-62 mm	37 mm	94 mm
Change in Operating Weight (without Ballast)	1136 kg	856 kg	3287 kg	3764 kg

Changes Specific to the 966M

Change in Static Tipping Load – Straight	821 kg	618 kg	2375 kg	2719 kg
Change in Static Tipping Load – Articulated	732 kg	551 kg	2118 kg	2425 kg

Changes Specific to the 972M

Change in Static Tipping Load – Straight	764 kg	576 kg	2212 kg	2533 kg
Change in Static Tipping Load – Articulated	680 kg	513 kg	1969 kg	2255 kg

*Width over bulge and includes tire growth.

NOTE: Changes compared to:

- 966M with Michelin 26.5R25 XHA2 L3 radial tires.
- 972M with Michelin 26.5R25 XHA2 L3 radial tires.

966M/972M Wheel Loaders Specifications

966M Bucket Fill Factors and Selection Chart

The bucket size must be chosen based on the density of the material and on the expected fill factor. The new Cat Performance Series Buckets with longer floor, larger bucket opening, increased repository angle, rounded side boards and integrated spill guard, demonstrate fill factors significantly higher than previous generation or non Cat buckets. The actual volume handled by the machine is thus often larger than the rated capacity.

Loose Material		Fill Factor (%)*	Material Density
Earth/Clay		115	1.5-1.7
Sand and Gravel		115	1.5-1.7
Aggregate:	25-76 mm	110	1.6-1.7
	19 mm and smaller	105	1.8
Rock:	76 mm and larger	100	1.6

*As a % of ISO rated capacity.

Note: Fill Factors achieved will also depend on whether the product is washed or not washed.

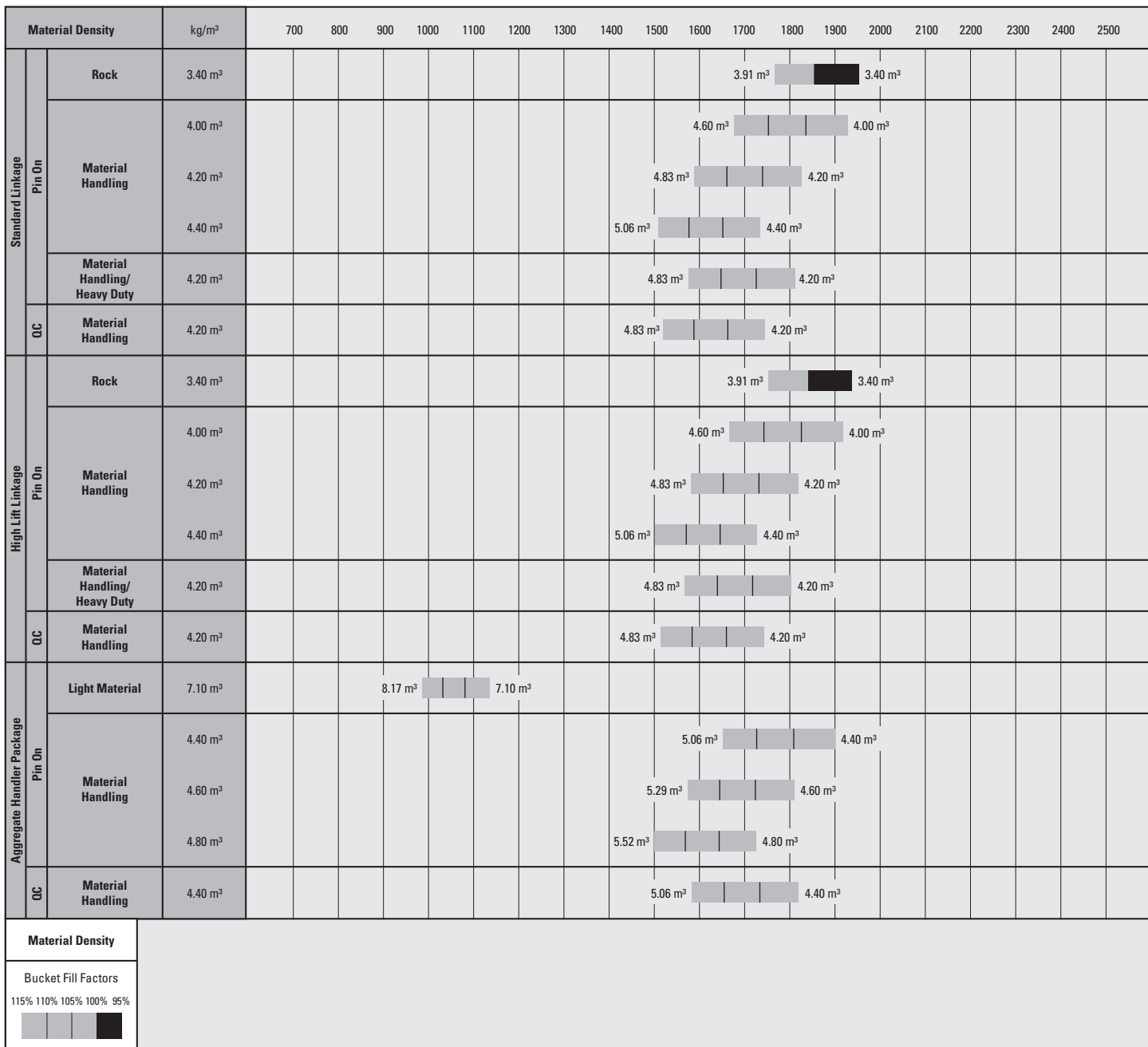



Note: All buckets are showing Bolt-On Edges.

QC = Quick Coupler

966M/972M Wheel Loaders Specifications

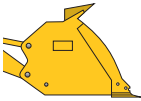
966M Operating Specifications with Buckets

Linkage		Standard Linkage						High Lift Linkage Change**
Pin/Quick Coupler								
Bucket Type		Material Handling		Material Handling Heavy Duty		Material Handling	Material Handling	
Edge Type		Bolt-On Cutting Edges	Teeth and Segments	Bolt-On Cutting Edges	FMT	Bolt-On Cutting Edges	Bolt-On Cutting Edges	
Capacity – Rated	m ³	4.20	4.20	4.20	4.20	4.20	4.20	—
Capacity – Rated at 110% Fill Factor	m ³	4.62	4.62	4.62	4.62	4.62	3.80	—
Width	mm	3220	3271	3220	3201	3220	3220	—
16 † Dump Clearance at Maximum Lift and 45° Discharge	mm	2949	2787	2949	3001	2899	2787	559
17 † Reach at Maximum Lift and 45° Discharge	mm	1245	1372	1245	1236	1296	1498	-25
Reach at Level Lift Arm and Bucket Level	mm	2774	2978	2774	2731	2845	3067	404
A † Digging Depth	mm	124	124	124	94	124	60	-25
12 † Shipping Length (with Bucket)	mm	8721	8946	8721	8653	8792	8961	825
B † Overall Height with Bucket at Maximum Lift	mm	5901	5901	5901	5940	5943	6134	559
Loader Clearance Circle with Bucket at Carry Position	mm	15 008	15 178	15 008	14 946	15 038	15 121	484
Static Tipping Load, Straight (With Tire Deflection)*	kg	16 580	16 398	16 465	16 155	15 919	14 950	55
Static Tipping Load, Straight (No Tire Deflection)*	kg	17 731	17 546	17 615	17 312	17 052	16 058	-32
Static Tipping Load, Articulated (With Tire Deflection)*	kg	14 605	14 421	14 489	14 162	13 969	13 078	-128
Static Tipping Load, Articulated (No Tire Deflection)*	kg	15 740	15 555	15 623	15 307	15 091	14 177	-187
Breakout Force	kN	177	175	176	180	167	141	-15
Operating Weight*	kg	23 217	23 355	23 336	23 706	23 678	23 889	1612

*Static tipping loads and operating weights shown are based on a machine configuration with Michelin 26.5R25 XHA2 L3 radial tires, full fluids, operator, standard counterweight, cold start, roading fenders, Product Link, manual diff lock/open axles (front/rear), power train guard, secondary steering and sound suppression.

**Maximum values.

(With Tire Deflection) Full compliance to ISO 14397-1 (2007) Sections 1 thru 6, which requires 2% verification between calculations and testing.

(No Tire Deflection) Compliance to ISO 14397-1 (2007) Sections 1 thru 5.

†Illustration shown with Dimension charts.

FMT = Flush Mounted Teeth

QC = Quick Coupler

966M/972M Wheel Loaders Specifications

966M Operating Specifications with Buckets

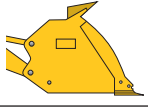
Linkage	Standard Linkage							High Lift Linkage Change**
Pin/Quick Coupler								
Bucket Type	Material Handling (Roading)		Material Handling		Rock (V-Edge)			
	Bolt-On Cutting Edges	FMT	Bolt-On Cutting Edges	Teeth and Segments	Bolt-On Cutting Edges	Teeth and Segments		
Capacity – Rated	m ³	4.20	4.20	4.40	4.40	3.40	3.40	—
Capacity – Rated at 110% Fill Factor	m ³	3.70	3.56	4.84	4.84	3.74	3.74	—
Width	mm	2995	3000	3220	3271	3252	3252	—
16 † Dump Clearance at Maximum Lift and 45° Discharge	mm	2969	3020	2921	2758	3124	3026	559
17 † Reach at Maximum Lift and 45° Discharge	mm	1406	1393	1274	1401	1419	1541	-25
Reach at Level Lift Arm and Bucket Level	mm	2854	2811	2814	3018	2783	2939	405
A † Digging Depth	mm	124	94	124	124	68	68	-25
12 † Shipping Length (with Bucket)	mm	8801	8733	8761	8986	8715	8876	829
B † Overall Height with Bucket at Maximum Lift	mm	5939	5939	5931	5931	5845	5845	559
Loader Clearance Circle with Bucket at Carry Position	mm	14 842	14 801	15 028	15 199	15 058	15 144	486/470
Static Tipping Load, Straight (With Tire Deflection)*	kg	16 858	16 957	16 501	16 318	17 075	17 006	-62/58
Static Tipping Load, Straight (No Tire Deflection)*	kg	18 022	18 129	17 657	17 471	18 262	18 191	-145/-7
Static Tipping Load, Articulated (With Tire Deflection)*	kg	14 889	14 979	14 527	14 343	15 033	14 963	-220/-111
Static Tipping Load, Articulated (No Tire Deflection)*	kg	16 034	16 132	15 668	15 481	16 204	16 133	-288/-163
Breakout Force	kN	168	173	171	170	186	185	-15
Operating Weight*	kg	22 848	22 833	23 270	23 408	24 007	24 059	1612

*Static tipping loads and operating weights shown are based on a machine configuration with Michelin 26.5R25 XHA2 L3 radial tires, full fluids, operator, standard counterweight, cold start, roading fenders, Product Link, manual diff lock/open axles (front/rear), power train guard, secondary steering and sound suppression.

**Maximum values (Rock/Other Buckets).

(With Tire Deflection) Full compliance to ISO 14397-1 (2007) Sections 1 thru 6, which requires 2% verification between calculations and testing.



(No Tire Deflection) Compliance to ISO 14397-1 (2007) Sections 1 thru 5.

†Illustration shown with Dimension charts.

FMT = Flush Mounted Teeth

966M/972M Wheel Loaders Specifications

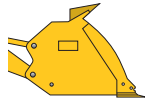
966M Operating Specifications with Buckets – Aggregate Handler

Linkage		Aggregate Handler					
Pin/Quick Coupler							
		Pin On			Fusion QC	Universal QC	
Bucket Type		Material Handling			Light Material	Material Handling	Material Handling
Edge Type		Bolt-On Cutting Edges	Bolt-On Cutting Edges	Bolt-On Cutting Edges	Bolt-On Cutting Edges	Bolt-On Cutting Edges	Bolt-On Cutting Edges
Capacity – Rated	m ³	4.40	4.60	4.80	7.10	4.40	4.40
Capacity – Rated at 110% Fill Factor	m ³	4.84	5.06	5.28	7.81	4.84	4.00
Width	mm	3220	3220	3220	3447	3220	3220
16 † Dump Clearance at Maximum Lift and 45° Discharge	mm	2921	2893	2865	2625	2872	2841
17 † Reach at Maximum Lift and 45° Discharge	mm	1274	1302	1330	1548	1323	1622
Reach at Level Lift Arm and Bucket Level	mm	2814	2854	2894	3217	2884	3104
A † Digging Depth	mm	124	124	124	140	124	60
12 † Shipping Length (with Bucket)	mm	8809	8849	8889	9224	8879	9046
B † Overall Height with Bucket at Maximum Lift	mm	5931	5982	6023	6071	5973	6183
Loader Clearance Circle with Bucket at Carry Position	mm	15 028	15 048	15 068	15 455	15 058	15 142
Static Tipping Load, Straight (With Tire Deflection)*	kg	18 077	18 013	17 938	17 508	17 397	16 505
Static Tipping Load, Straight (No Tire Deflection)*	kg	19 386	19 329	19 260	18 881	18 687	17 789
Static Tipping Load, Articulated (With Tire Deflection)*	kg	15 861	15 799	15 726	15 301	15 209	14 390
Static Tipping Load, Articulated (No Tire Deflection)*	kg	17 158	17 103	17 036	16 663	16 492	15 670
Breakout Force	kN	171	166	161	129	162	138
Operating Weight*	kg	23 965	24 000	24 046	24 223	24 427	24 592

*Static tipping loads and operating weights shown are based on a machine configuration with Michelin 26.5R25 XHA2 L3 radial tires, full fluids, operator, aggregate counterweight, cold start, roading fenders, Product Link, manual diff lock/open axles (front/rear), power train guard, secondary steering and sound suppression. If a rock bucket is added, those values are with Michelin 26.5R25 XLDD2 L5 tires.

(With Tire Deflection) Full compliance to ISO 14397-1 (2007) Sections 1 thru 6, which requires 2% verification between calculations and testing.

(No Tire Deflection) Compliance to ISO 14397-1 (2007) Sections 1 thru 5.

†Illustration shown with Dimension charts.

QC = Quick Coupler

966M/972M Wheel Loaders Specifications

972M Bucket Fill Factors and Selection Chart

The bucket size must be chosen based on the density of the material and on the expected fill factor. The new Cat Performance Series Buckets with longer floor, larger bucket opening, increased repository angle, rounded side boards and integrated spill guard, demonstrate fill factors significantly higher than previous generation or non Cat buckets. The actual volume handled by the machine is thus often larger than the rated capacity.

Loose Material		Fill Factor (%)*	Material Density
Earth/Clay		115	1.5-1.7
Sand and Gravel		115	1.5-1.7
Aggregate:	25-76 mm	110	1.6-1.7
	19 mm and smaller	105	1.8
Rock:	76 mm and larger	100	1.6

*As a % of ISO rated capacity.

Note: Fill Factors achieved will also depend on whether the product is washed or not washed.

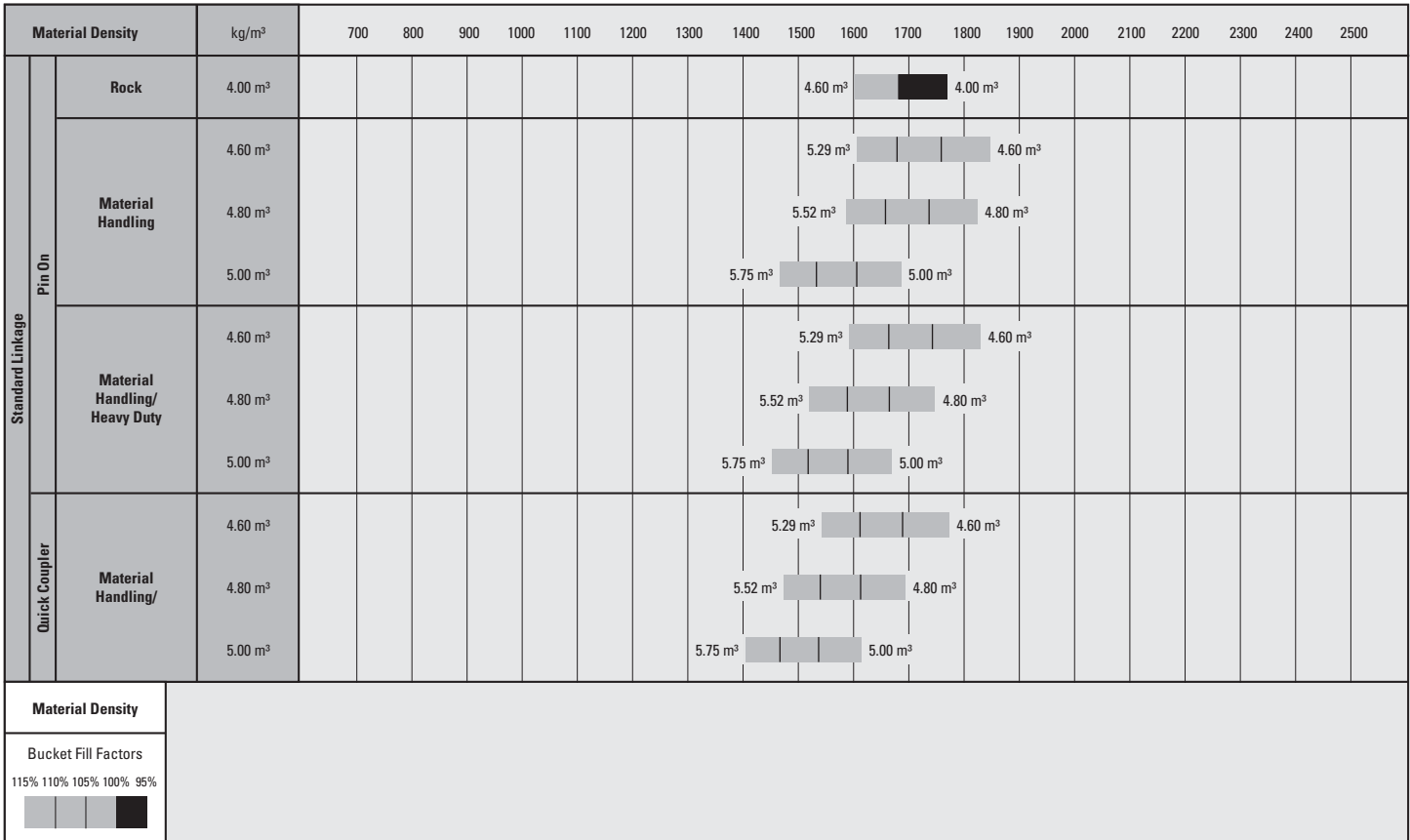

Note: All buckets are showing Bolt-On Edges.

966M/972M Wheel Loaders Specifications

972M Bucket Fill Factors and Selection Chart

The bucket size must be chosen based on the density of the material and on the expected fill factor. The new Cat Performance Series Buckets with longer floor, larger bucket opening, increased repository angle, rounded side boards and integrated spill guard, demonstrate fill factors significantly higher than previous generation or non Cat buckets. The actual volume handled by the machine is thus often larger than the rated capacity.

Loose Material		Fill Factor (%)*	Material Density
Earth/Clay		115	1.5-1.7
Sand and Gravel		115	1.5-1.7
Aggregate:	25-76 mm	110	1.6-1.7
	19 mm and smaller	105	1.8
Rock:	76 mm and larger	100	1.6

*As a % of ISO rated capacity.

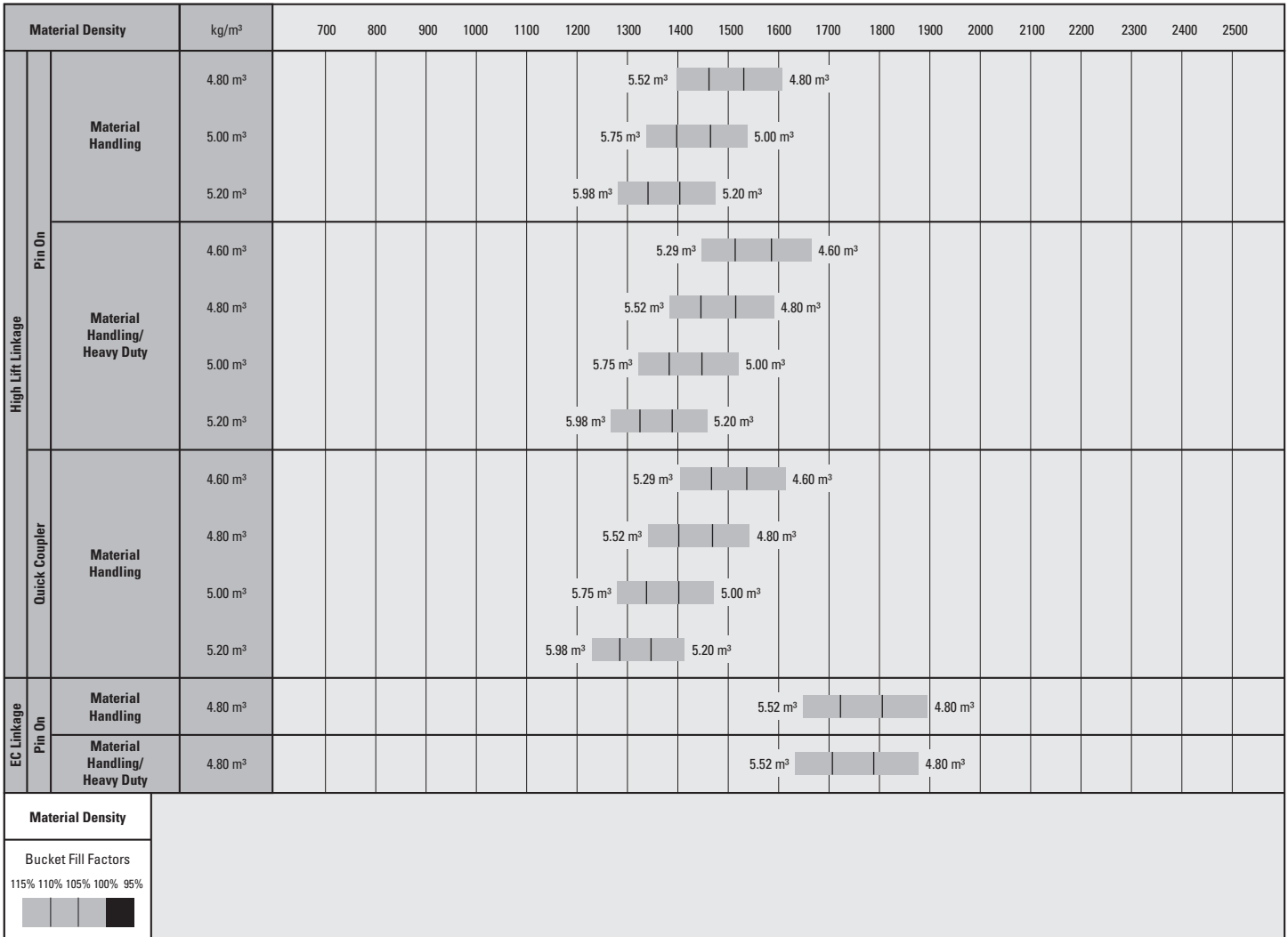

Note: Fill Factors achieved will also depend on whether the product is washed or not washed.



Note: All buckets are showing Bolt-On Edges.
EC = Extended Capacity

966M/972M Wheel Loaders Specifications

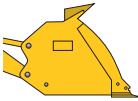
972M Operating Specifications with Buckets

Linkage		Standard Linkage						High Lift Linkage Change**
Pin/Quick Coupler								
	Pin On				Fusion QC	Universal QC		
Bucket Type		Material Handling				Material Handling	Material Handling	
Edge Type		Bolt-On Cutting Edges	Teeth and Segments	Bolt-On Cutting Edges	Teeth and Segments	Bolt-On Cutting Edges	Bolt-On Cutting Edges	
Capacity – Rated	m ³	4.80	4.80	5.00	5.00	4.60	4.60	—
Capacity – Rated at 110% Fill Factor	m ³	5.28	5.28	5.50	5.50	5.06	5.06	—
Width	mm	3220	3271	3220	3271	3220	3220	—
16 † Dump Clearance at Maximum Lift and 45° Discharge	mm	3099	2936	3070	2908	3069	2954	336
17 † Reach at Maximum Lift and 45° Discharge	mm	1272	1399	1300	1427	1301	1507	23
Reach at Level Lift Arm and Bucket Level	mm	3009	3214	3049	3254	3050	3277	274
A † Digging Depth	mm	103	103	103	103	103	39	-5
12 † Shipping Length (with Bucket)	mm	9310	9534	9350	9574	9351	9529	338
B † Overall Height with Bucket at Maximum Lift	mm	6193	6193	6223	6223	6199	6439	336
Loader Clearance Circle with Bucket at Carry Position	mm	15 213	15 391	15 235	15 414	15 231	15 332	337
Static Tipping Load, Straight (With Tire Deflection)*	kg	18 380	18 196	18 306	18 121	17 763	16 413	-1598
Static Tipping Load, Straight (No Tire Deflection)*	kg	19 613	19 425	19 545	19 357	18 970	17 566	-1763
Static Tipping Load, Articulated (With Tire Deflection)*	kg	16 050	15 864	15 977	15 790	15 463	14 230	-1429
Static Tipping Load, Articulated (No Tire Deflection)*	kg	17 288	17 101	17 222	17 034	16 679	15 398	-1608
Breakout Force	kN	196	195	191	189	191	160	-7
Operating Weight*	kg	24 977	25 114	25 026	25 164	25 409	25 690	85

*Static tipping loads and operating weights shown are based on a machine configuration with Michelin 26.5R25 XHA2 L3 radial tires, full fluids, operator, standard counterweight, cold start, roading fenders, Product Link, manual diff lock/open axles (front/rear), power train guard, secondary steering and sound suppression.

**Maximum values.

(With Tire Deflection) Full compliance to ISO 14397-1 (2007) Sections 1 thru 6, which requires 2% verification between calculations and testing.

(No Tire Deflection) Compliance to ISO 14397-1 (2007) Sections 1 thru 5.

†Illustration shown with Dimension charts.

QC = Quick Coupler

966M/972M Wheel Loaders Specifications

972M Operating Specifications with Buckets

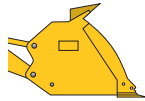
Linkage		Standard Linkage					High Lift Linkage Change**
Pin/Quick Coupler							
Bucket Type		Material Handling Heavy Duty				Rock (V-Edge)	Teeth and Segments
Edge Type		Bolt-On Cutting Edges	FMT	Bolt-On Cutting Edges	FMT		
Capacity – Rated	m ³	4.80	4.80	5.00	4.97	4.00	—
Capacity – Rated at 110% Fill Factor	m ³	5.28	5.28	5.50	5.47	4.40	—
Width	mm	3220	3294	3220	3294	3350	—
16 † Dump Clearance at Maximum Lift and 45° Discharge	mm	3099	2933	3070	2911	3160	336
17 † Reach at Maximum Lift and 45° Discharge	mm	1272	1476	1300	1497	1547	23
Reach at Level Lift Arm and Bucket Level	mm	3009	3271	3049	3301	3171	274
A † Digging Depth	mm	103	78	103	78	50	-5
12 † Shipping Length (with Bucket)	mm	9310	9551	9350	9581	9472	338
B † Overall Height with Bucket at Maximum Lift	mm	6193	6234	6234	6265	6057	335
Loader Clearance Circle with Bucket at Carry Position	mm	15 213	15 405	15 235	15 422	15 452	339
Static Tipping Load, Straight (With Tire Deflection)*	kg	18 233	17 921	18 151	17 857	18 317	-1583
Static Tipping Load, Straight (No Tire Deflection)*	kg	19 464	19 161	19 388	19 101	19 562	-1747
Static Tipping Load, Articulated (With Tire Deflection)*	kg	15 901	15 570	15 820	15 507	15 920	-1416
Static Tipping Load, Articulated (No Tire Deflection)*	kg	17 139	16 820	17 065	16 761	17 177	-1593
Breakout Force	kN	196	200	190	195	193	-7
Operating Weight*	kg	25 121	25 506	25 176	25 550	26 189	85

*Static tipping loads and operating weights shown are based on a machine configuration with Michelin 26.5R25 XHA2 L3 radial tires, full fluids, operator, standard counterweight, cold start, roading fenders, Product Link, manual diff lock/open axles (front/rear), power train guard, secondary steering and sound suppression.

**Maximum values.

(With Tire Deflection) Full compliance to ISO 14397-1 (2007) Sections 1 thru 6, which requires 2% verification between calculations and testing.

(No Tire Deflection) Compliance to ISO 14397-1 (2007) Sections 1 thru 5.

†Illustration shown with Dimension charts.

FMT = Flush Mounted Teeth

966M/972M Wheel Loaders Specifications

972M Operating Specifications with Buckets

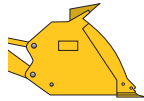
Linkage	Extended Capacity Linkage				
Pin/Quick Coupler					
Bucket Type	Material Handling		Material Handling Heavy Duty		
Edge Type	Bolt-On Cutting Edges	Teeth and Segments	Bolt-On Cutting Edges	Teeth and Segments	
Capacity – Rated	m ³	4.80	4.80	4.80	4.80
Capacity – Rated at 110% Fill Factor	m ³	5.28	5.28	4.40	4.40
Width	mm	3220	3271	3220	3271
16 † Dump Clearance at Maximum Lift and 45° Discharge	mm	2876	2713	2876	2713
17 † Reach at Maximum Lift and 45° Discharge	mm	1320	1446	1320	1446
Reach at Level Lift Arm and Bucket Level	mm	2879	3083	2879	3083
A † Digging Depth	mm	123	123	123	123
12 † Shipping Length (with Bucket)	mm	9145	9370	9145	9370
B † Overall Height with Bucket at Maximum Lift	mm	5971	5971	5971	5971
Loader Clearance Circle with Bucket at Carry Position	mm	15 061	15 232	15 061	15 232
Static Tipping Load, Straight (With Tire Deflection)*	kg	19 998	19 813	19 851	19 665
Static Tipping Load, Straight (No Tire Deflection)*	kg	21 453	21 263	21 303	21 113
Static Tipping Load, Articulated (With Tire Deflection)*	kg	17 500	17 312	17 351	17 163
Static Tipping Load, Articulated (No Tire Deflection)*	kg	18 944	18 754	18 793	18 603
Breakout Force	kN	207	206	207	205
Operating Weight*	kg	24 769	24 907	24 913	25 051

*Static tipping loads and operating weights shown are based on a machine configuration with Michelin 26.5R25 XHA2 L3 radial tires, full fluids, operator, standard counterweight, cold start, roading fenders, Product Link, manual diff lock/open axles (front/rear), power train guard, secondary steering and sound suppression.

**Maximum values.

(With Tire Deflection) Full compliance to ISO 14397-1 (2007) Sections 1 thru 6, which requires 2% verification between calculations and testing.

(No Tire Deflection) Compliance to ISO 14397-1 (2007) Sections 1 thru 5.

†Illustration shown with Dimension charts.

Standard Equipment

Standard equipment may vary. Consult your Cat dealer for details.

OPERATOR ENVIRONMENT

- Cab, pressurized and sound suppressed (ROPS/FOPS)
- Viscous mounts
- Multi-function 18 cm color LCD touch-screen display for rear vision camera image display (reverse travel activated) and machine status, setting and health parameters
- EH controls, SAL (single axis lever) lift and tilt function
- Steering, EH joystick, speed sensing with force feedback
- Radio ready (entertainment) includes antenna, speakers and converter (12V, 10-amp)
- Air conditioner, heater, and defroster (auto temp and fan)
- EH parking brake
- Beverage holders (2) with storage compartment for cell phone/MP3 player
- Bucket/work tool function lockout
- Coat hook (2)
- Cab air filter
- Ergonomic cab access ladders and handrails
- Horn, electric
- Light, two dome (cab)
- Mirrors, rearview external with integrated spot mirrors
- Post mounted membrane 16 switch keypad
- 2 receptacles, 12V
- Seat, Cat Comfort (cloth) air suspension
- Seat belt, 51 mm retractable, with indicator
- Sun visor, front
- Wet-arm wipers/washers front and rear, intermittent front wiper
- Window, sliding (left and right sides)
- Cab tie-off

COMPUTERIZED MONITORING SYSTEM

- With following gauges:
 - Speedometer/tachometer
 - Digital gear range indicator
 - Diesel Exhaust Fluid (DEF) level
 - Temperature: engine coolant, hydraulic oil, transmission oil
 - Fuel level

- With following warning indicators:
 - Regeneration
 - Temperature: axle oil, engine intake manifold
 - Pressure: engine oil, fuel pressure hi/low, primary steering oil, service brake oil
 - Battery voltage hi/low
 - Engine air filter restriction
 - Hydraulic oil filter restriction
 - Hydraulic oil low
 - Parking brake
 - DEF low level
 - Transmission filter bypass

ELECTRICAL AND LIGHTING

- Batteries (2), maintenance free 1,400 CCA
- Ignition key; start/stop switch
- Starter, electric, heavy duty
- Starting and charging system (24V)
- Lighting system:
 - Four halogen work lights (cab mounted)
 - Two front halogen roading lights (with signals)
 - Two halogen rear vision lights (hood mounted)
 - Two rear LED position/stop/turn signal lights
- Alarm, back-up
- Alternator, 145-amp brushed
- Main disconnect switch
- Emergency engine shutdown switch
- Receptacle start (cables not included)
- Secondary steering

CAT CONNECT TECHNOLOGIES

- Link technologies: Product Link
- Detect technologies: rear vision camera

POWER TRAIN

- Engine, Cat 9.3 ACERT – meets EU Stage IV emission standards
- Cat Clean Emissions Module (CEM) with Diesel Particulate Filter (DPF) and remote Diesel Exhaust Fluid (DEF) tank and pump
- Fuel priming pump (electric)
- Fuel/water separator
- Precleaner, engine air intake
- Economy Mode (selectable)
- Transmission, automatic planetary power shift (4F/4R)
- Torque converter, locking clutch with free wheel stator
- Switch, transmission neutralizer lockout

- Axles, manually actuated differential lock front axle, open differential rear axle
- Axles, ecology drains
- Brakes, full hydraulic enclosed wet-disc with Integrated Braking System (IBS)
- Brake wear indicators
- Parking brake, disc and caliper
- Fan, radiator, electronically controlled, hydraulically driven, temperature sensing, on demand
- Radiator, high debris with wider fin spacing

LINKAGE

- Linkage, Z-bar, cast crosstube/tilt lever
- Kickout, lift and tilt, automatic (adjustable in cab)

HYDRAULICS

- Hydraulic system, load sensing
- Steering, load sensing
- Ride control, 2V
- Remote diagnostic pressure taps
- Hoses, Cat XT
- Couplings, Cat O-ring face seal
- Hydraulic oil cooler (swing out)
- Oil sampling valves

FLUIDS

- Premixed extended life coolant with freeze protection to –34° C

OTHER STANDARD EQUIPMENT

- Hood, non-metallic power tilting with rear clamshell
- Service centers (electrical and hydraulic)
- Platform, window washing
- Auto idle shutdown
- Fenders, steel front with mud-flap/rear with extension
- Ecology drains for engine, transmission, and hydraulics
- Ether aid ready
- Grill, airborne debris
- Filters: fuel, engine air, engine oil, hydraulic oil, transmission
- Fuel cooler
- Grease zerks
- Hitch, drawbar with pin
- Precleaner rain cap
- Sight gauges: engine coolant, hydraulic oil, and transmission oil level
- Toolbox
- Vandalism protection caplocks

Optional Equipment

Optional equipment may vary. Consult your Cat dealer for details.

OPERATOR ENVIRONMENT

- Door, remote opening system
- Cover, HVAC metallic
- EH controls, SAL 3rd function
 - Additional roller switch for 4th function
- EH controls, joystick lift and tilt
 - Additional integrated roller switches for 3rd and 4th functions
- Filter, carbon fresh air
- Mirrors, heated rearview external with integrated spot mirrors
- Precleaner, HVAC
- Precleaner, HVAC (RESPA)
- Radio, AM/FM/CD/USB/MP3 Bluetooth
- Radio, CB ready
- Seat, heated air suspension
- Seat belt, 4 point harness, with indicator
- Steering, EH wheel with directional FNR shifter and gear selector
 - Additional FNR switch near implement controls
- Roof, metallic
- Sun visor, rear
- Windows, rubber mounted
- Windows, with front guard
- Windows, with heavy duty front guard
- Windows, with full guards front, rear and sides

ELECTRICAL AND LIGHTING

- Four additional halogen cab mounted work lights or;
- Four additional HID cab mounted work lights
- LED front and rear roading lights
- Speed limiter – 20 km/h

STARTERS, BATTERIES, AND ALTERNATORS

- Cold start – 240V

CAT CONNECT TECHNOLOGIES

- Link technologies: VIMS™
- Payload technologies:
 - Aggregate Autodig
 - Cat Production Measurement
 - Printer, Cat Production Measurement
- Detect technologies: dedicated display for rear vision camera, full-time activation
- Machine Security System

POWER TRAIN

- Axles
 - Automatic front/rear differential locks
 - Axle oil cooler
 - Extreme temperature seals
 - Seal guards
- Fan, VPF (variable pitch fan), automatic and manual control
- Radiator, high ambient capability with lower fan spacing

LINKAGE

- High lift
- Forestry (966 only)
- Extended capacity (972 only)
- Quick coupler ready

WORK TOOLS

- Performance Series buckets
- Fusion quick coupler
- Forks, pallet
- Forks, logging

HYDRAULICS

- 3rd function with Ride Control
- 4th function with Ride Control
- Autolube

FLUIDS

- Premixed extended life coolant with freeze protection to –50° C
- Bio-degradable oil, Cat Hydo

OTHER OPTIONAL EQUIPMENT

- Fenders, roading
- Guard, power train
- Guard, rear radiator grill
- Oil change, high speed engine
- Precleaner, turbine
- Precleaner, trash

OTHER OPTIONAL CONFIGURATIONS

- Aggregate Handler
- Industrial and Waste Handler
- Forestry (966M)
- Steel Mill (972M)

For more complete information on Cat products, dealer services, and industry solutions, visit us on the web at www.cat.com

AEHQ7115 (05-2014)
(Europe)

© 2014 Caterpillar
All rights reserved

Materials and specifications are subject to change without notice. Featured machines in photos may include additional equipment. See your Cat dealer for available options.

CAT, CATERPILLAR, SAFETY.CAT.COM, their respective logos, "Caterpillar Yellow" and the "Power Edge" trade dress, as well as corporate and product identity used herein, are trademarks of Caterpillar and may not be used without permission.

VisionLink is a trademark of Trimble Navigation Limited, registered in the United States and in other countries.

